



**GOVERNMENT OF TAMILNADU**

**STANDARD TEN**

**SCIENCE**

A Publication under Free Textbook Programme of Government of Tamil Nadu

**Department of School Education**

**Untouchability is Inhuman and a Crime**

**Government of Tamil Nadu**

First Edition - 2019

Revised Edition - 2020

(Published under New syllabus)

**NOT FOR SALE**

**Content Creation**

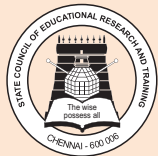

State Council of Educational  
Research and Training  
© SCERT 2019

**Printing & Publishing**



Tamil Nadu Textbook and  
Educational Services Corporation  
[www.textbooksonline.tn.nic.in](http://www.textbooksonline.tn.nic.in)

## PREFACE

This book is developed in a holistic approach which inculcates comprehending and analytical skills. It will be helpful for the students to understand higher secondary science in a better way and to prepare for competitive exams in future. This textbook is designed in a learner centric way to trigger the thought process of students through activities and to make them excel in learning science.

- This book has 23 units.
- Each unit has simple activities that can be demonstrated by the teacher and also few group activities are given for students to do under the guidance of the teacher.
- Infographics and info-bits are added to enrich the learner's scientific perception.
- The "Do you know?" and "More to know" placed in the units will be an eye opener.
- Glossary has been introduced to learn scientific terms.
- ICT corner and QR code are introduced in each unit for the digital native generation.

## HOW TO USE THE BOOK?

### How to get connected to QR Code?

- Download the QR code scanner from the google play store/apple app store into your smartphone
- Open the QR code scanner application
- Once the scanner button in the application is clicked, camera opens and then bring it closer to the QR code in the textbook.
- Once the camera detects the QR code, a URL appears in the screen. Click the URL and go to the content page.



# Career Guidance



# → Road ahead after 12<sup>th</sup> ...



## B.Sc., Courses 3 years

- B.Sc. Physics
- B.Sc. Chemistry
- B.Sc. Botany
- B.Sc. Zoology
- B.Sc. Mathematics
- B.Sc. Computer Science
- B.Sc. PCM
- B.Sc. CBZ
- B.Sc. Dietician & Nutritionist
- B.Sc. Sericulture
- B.Sc. Oceanography
- B.Sc. Meteorology
- B.Sc. Anthropology
- B.Sc. Forensic Sciences
- B.Sc. Food Technology
- B.Sc. Dairy Technology
- B.Sc. Hotel Management
- B.Sc. Fashion Design
- B.Sc. Mass Communication
- B.Sc. Electronic Media
- B.Sc. Multimedia
- B.Sc. 3D Animation
- B.Sc. Home Science



## Commerce Courses 3 years

- CA – Chartered Accountant
- CMA Cost Management Accountant
- CS Company Secretary (Foundation)
- B.com – Regular
- B.com – Taxation & Tax Procedure
- B.com – Travel & Tourism
- B.com – Bank Management
- B.com – Professional
- BBA/BBM – Regular
- BFM – Bachelors in Financial Markets
- BMS – Bachelors in Management Studies
- BAF – Bachelors in Accounting & Finance
- Certified Stock Broker & Investment Analysis
- Certified Financial Analyst
- Certified Financial Planner
- Certified Investment Banker



## Law Courses 3.5 years

- LLB
- BA+LLB
- B.Com + LLB
- BBM+LLB
- BBA+LLB

## Management Courses (3 years)

- Business Management
- Bank Management
- Event Management
- Hospital Management
- Hotel Management
- Human Resources Management
- Logistics & Management

## C.A

CPT  
↓  
ATC IPCC  
↓  
ITT  
(100 Hours)  
↓  
Articleship  
(Work under in CA)  
↓  
Clear Final Exam  
Become a C.A.

JOB / Post Graduation

# Table of Contents

Unit	Title	Page No.	Month
1	Laws of Motion	1	June
2	Optics	16	July
3	Thermal Physics	32	August
4	Electricity	42	September
5	Acoustics	59	October
6	Nuclear Physics	74	November
7	Atoms and Molecules	91	June
8	Periodic Classification of Elements	106	July
9	Solutions	124	August
10	Types of Chemical Reactions	137	October
11	Carbon and its Compounds	155	November
12	Plant Anatomy and Plant Physiology	173	June



E - book



Assessment



B375\_10\_SCIENCE\_EM

DIGI links

<b>Unit</b>	<b>Title</b>	<b>Page No.</b>	<b>Month</b>
13	Structural Organisation of Animals	187	June
14	Transportation in Plants and Circulation in Animals	200	July
15	Nervous System	218	July
16	Plant and Animal Hormones	229	August
17	Reproduction in Plants and Animals	243	August
18	Genetics	261	September
19	Origin and Evolution of Life	274	October
20	Breeding and Biotechnology	286	October
21	Health and Diseases	300	November
22	Environmental Management	315	November
23	Visual Communication	329	December
<b>Practicals</b>		334	
<b>Glossary</b>		350	



# STANDARD TEN

# SCIENCE





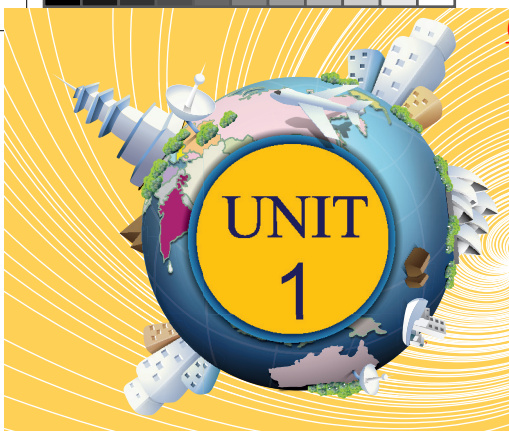

## LAWS OF MOTION



## Learning Objectives

At the end of this lesson students will be able to:

- ◆ Understand the concepts of force and motion.
- ◆ Explain inertia and its types.
- ◆ State the three laws of Newton.
- ◆ Apply Newtonian concept of force and motion.
- ◆ Define force, momentum and impulse.
- ◆ Distinguish between mass and weight
- ◆ Analyze weightlessness and the principle of conservation of momentum.
- ◆ Explain the law of gravitation and its applications.
- ◆ Understand the variations in 'g' due to height and depth.
- ◆ Solve numerical problems related to force and motion



2ZGABR

## INTRODUCTION

Human beings are so curious about things around them. Things around us are related to one another. Some bodies are at rest and some are in motion. Rest and motion are interrelated terms.

In the previous classes you have learnt about various types of motion such as linear motion, circular motion, oscillatory motion, and so on. So far, you have discussed the motion of bodies in terms of their displacement, velocity, and acceleration. In this unit, let us investigate the cause of motion.

When a body is at rest, starts moving, a question that arises in our mind is 'what causes the body to move?' Similarly, when a moving object comes to rest, you would like to know what brings it to rest? If a moving object speeds

up or slows down or changes its direction. what speeds up or slows down the body? What changes the direction of motion?

One answer for all the above questions is 'Force'. In a common man's understanding of motion, a body needs a 'push' or 'pull' to move, or bring to rest or change its velocity. Hence, this 'push' or 'pull' is called as 'force'.

Let us define force in a more scientific manner using the three laws proposed by Sir Isaac Newton. These laws help you to understand the motion of a body and also to predict the future course of its motion, if you know the forces acting on it. Before Newton formulated his three laws of motion, a different perception about the force and motion of bodies prevailed. Let us first look at these ideas and then eventually learn about Newton's laws in this unit.

*Mechanics* is the branch of physics that deals with the effect of force on bodies. It is divided into two branches, namely, statics and dynamics.

**Statics:** It deals with the bodies, which are at rest under the action of forces.

**Dynamics:** It is the study of moving bodies under the action of forces. Dynamics is further divided as follows.

**Kinematics:** It deals with the motion of bodies without considering the cause of motion.

**Kinetics:** It deals with the motion of bodies considering the cause of motion.

### 1.1 FORCE AND MOTION

According to *Aristotle* a Greek Philosopher and Scientist, the natural state of earthly bodies is 'rest'. He stated that a moving body naturally comes to rest without any external influence of the force. Such motions are termed as '**natural motion**' (**Force independent**). He also proposed that a force (a push or a pull) is needed to make the bodies to move from their natural state (rest) and behave contrary to their own natural state called as '**violent motion**' (**Force dependent**). Further, he said, when two different mass bodies are dropped from a height, the heavier body falls faster than the lighter one.

*Galileo* proposed the following concepts about force, motion and inertia of bodies:

- (i) The natural state of all earthly bodies is either the state of rest or the state of uniform motion.
- (ii) A body in motion will continue to be in the same state of motion as long as no external force is applied.
- (iii) When a force is applied on bodies, they resist any change in their state. This property of bodies is called 'inertia'.
- (iv) When dropped from a height in vacuum, bodies of different size, shape and mass fall at the same rate and reach the ground at the same time.

### 1.2 INERTIA

While you are travelling in a bus or in a car, when a sudden brake is applied, the upper part of your body leans in the forward direction. Similarly, when the vehicle suddenly moves forward from rest, you lean backward. This is due to, any body would like to continue to be in its state of rest or the state of motion. This is known as 'inertia'.

The inherent property of a body to resist any change in its state of rest or the state of uniform motion, unless it is influenced upon by an external unbalanced force, is known as '**inertia**'.

#### Activity 1

Take a glass tumbler and place a small cardboard on it as shown in the figure. Now, keep a coin at the centre of the cardboard. Then, flick the cardboard quickly. What do you observe?

The cardboard falls off the ground and the coin falls into the glass tumbler.

#### Inertia of rest

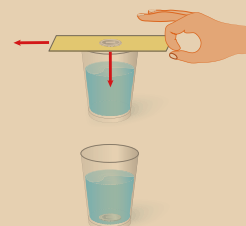

In activity described above, the inertia of the coin keeps it in the state of rest when the cardboard moves. Then, when the cardboard has moved, the coin falls into the tumbler due to gravity. This happens due to 'inertia of rest'.

#### 1.2.1 Types of Inertia

- a) **Inertia of rest:** The resistance of a body to change its state of rest is called inertia of rest.
- b) **Inertia of motion:** The resistance of a body to



change its state of motion is called inertia of motion.

- c) **Inertia of direction:** The resistance of a body to change its direction of motion is called inertia of direction.

### 1.2.2 Examples of Inertia

- ◆ An athlete runs some distance before jumping. Because, this will help him jump longer and higher. (Inertia of motion)
- ◆ When you make a sharp turn while driving a car, you tend to lean sideways, (Inertia of direction).
- ◆ When you vigorously shake the branches of a tree, some of the leaves and fruits are detached and they fall down, (Inertia of rest).



Figure 1.1 Inertia of motion

## 1.3 LINEAR MOMENTUM

The impact of a force is more if the velocity and the mass of the body is more. To quantify the impact of a force exactly, a new physical quantity known as linear momentum is defined. The linear momentum measures the impact of a force on a body.

**The product of mass and velocity of a moving body gives the magnitude of linear momentum. It acts in the direction of the velocity of the object.** Linear momentum is a vector quantity.

$$\text{Linear Momentum} = \text{mass} \times \text{velocity}$$

$$p = mv \dots\dots\dots(1.1)$$

It helps to measure the magnitude of a force. Unit of momentum in SI system is  $\text{kg m s}^{-1}$  and in C.G.S system its unit is  $\text{g cm s}^{-1}$ .

## 1.4 NEWTON'S LAWS OF MOTION

### 1.4.1 Newton's First Law

This law states that **every body continues to be in its state of rest or the state of uniform motion along a straight line unless it is acted upon by some external force.** It gives the definition of force as well as inertia.

### 1.4.2 Force

Force is an external effort in the form of push or pull, which:

1. produces or tries to produce the motion of a static body.
2. stops or tries to stop a moving body.
3. changes or tries to change the direction of motion of a moving body.

Force has both magnitude and direction. So, it is a vector quantity.

### 1.4.3 Types of forces

Based on the direction in which the forces act, they can be classified into two types as: (a) Like parallel forces and (b) Unlike parallel forces.

- (a) **Like parallel forces:** Two or more forces of equal or unequal magnitude acting along the same direction, parallel to each other are called like parallel forces.
- (b) **Unlike parallel forces:** If two or more equal forces or unequal forces act along opposite directions parallel to each other, then they are called unlike parallel forces. Action of forces are given in Table 1.1.

### 1.4.4 Resultant Force

When several forces act simultaneously on the same body, then the combined effect of the multiple forces can be represented by a single force, which is termed as '*resultant force*'. It is equal to the vector sum (adding the magnitude of the forces with their direction) of all the forces.

Table 1.1 Action of forces

Action of forces	Diagram	Resultant force ( $F_{net}$ )
Parallel forces are acting in the same direction		$F_{net} = F_1 + F_2$
Parallel unequal forces are acting in opposite directions		$F_{net} = F_1 - F_2$ (if $F_1 > F_2$ ) $F_{net} = F_2 - F_1$ (if $F_2 > F_1$ ) $F_{net}$ is directed along the greater force.
Parallel equal forces are acting in opposite directions in the same line of action ( $F_1 = F_2$ )		$F_{net} = F_1 - F_2$ $F_{net} = 0$ since ( $F_1 = F_2$ )



(a) Unlike parallel forces – Tug of war



(b) Unbalanced forces - Action of a lever

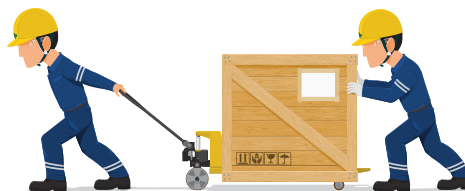

(c) Like parallel forces

Figure 1.2 Combined effect of forces

If the resultant force of all the forces acting on a body is equal to zero, then the body will be in equilibrium. Such forces are called **balanced forces**. If the resultant force is not equal to zero, then it causes the motion of the body due to **unbalanced forces**

**Examples:** Drawing water from a well, force applied with a crow bar, forces on a weight balance, etc.

A system can be brought to equilibrium by applying another force, which is equal to the resultant force in magnitude, but opposite in direction. Such force is called as ‘**Equilibrant**’.

### 1.4.5 Rotating Effect of Force

Have you observed the position of the handle in a door? It is always placed at the edge of door and not at some other place. Why? Have you tried to push a door by placing your hand closer to the hinges or the fixed edge? What do you observe?

The door can be easily opened or closed when you apply the force at a point far away from the fixed edge. In this case, the effect of the force you apply is to turn the door about the fixed edge. This turning effect of the applied force is more when the distance between the fixed edge and the point of application of force is more.

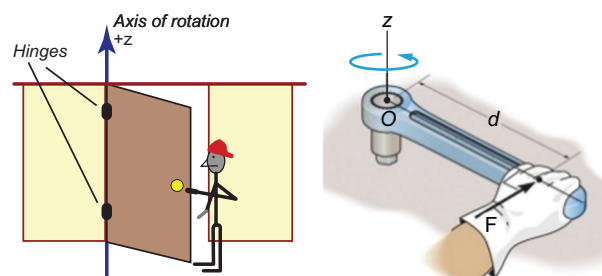

Figure 1.3 Rotating effect of a force

The axis of the fixed edge about which the door is rotated is called as the ‘**axis of rotation**’. Fix one end of a rod to the floor/wall, and apply a force at the other end tangentially.

The rod will be turned about the fixed point is called as 'point of rotation'.

### 1.4.6 Moment of the Force

The rotating or turning effect of a force about a fixed point or fixed axis is called **moment of the force** about that point or **torque** ( $\tau$ ). It is measured by the product of the force ( $F$ ) and the perpendicular distance ( $d$ ) between the fixed point or the fixed axis and the line of action of the force.

$$\tau = F \times d \dots \dots \dots (1.2)$$

Torque is a vector quantity. It is acting along the direction, perpendicular to the plane containing the line of action of force and the distance. Its SI unit is Nm.

**Couple:** Two equal and unlike parallel forces applied simultaneously at two distinct points constitute a couple. The line of action of the two forces does not coincide. It does not produce any translatory motion since the resultant is zero. But, a couple results in causes the rotation of the body. Rotating effect of a couple is known as **moment of a couple**.

**Examples:** Turning a tap, winding or unwinding a screw, spinning of a top, etc.

Moment of a couple is measured by the product of any one of the forces and the perpendicular distance between the line of action of two forces. The turning effect of a couple is measured by the magnitude of its moment.

Moment of a couple = Force  $\times$  perpendicular distance between the line of action of forces

$$M = F \times S \dots \dots \dots (1.3)$$

The unit of moment of a couple is newton metre (N m) in SI system and dyne cm in CGS system.

By convention, the direction of moment of a force or couple is taken as positive if the body is rotated in the anti-clockwise direction and

negative if it is rotate in the clockwise direction. They are shown in Figures 1.4 (a and b)

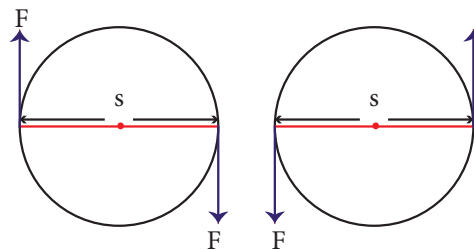

Figure 1.4 (a) Clockwise moment Figure 1.4 (b) Anticlockwise moment

### 1.4.7 Application of Torque

#### 1. Gears:

A gear is a circular wheel with teeth around its rim. It helps to change the speed of rotation of a wheel by changing the torque and helps to transmit power.



#### 2. Seasaw

Most of you have played on the seasaw. Since there is a difference in the weight of the persons sitting on it, the heavier person lifts the lighter person. When the heavier person comes closer to the pivot point (fulcrum) the distance of the line of action of the force decreases. It causes less amount of torque to act on it. This enables the lighter person to lift the heavier person.

#### 3. Steering Wheel

A small steering wheel enables you to manoeuvre a car easily by transferring a torque to the wheels with less effort.

### 1.4.8 Principle of Moments

When a number of like or unlike parallel forces act on a rigid body and the body is in equilibrium, then the algebraic sum of the moments in the clockwise direction is equal to the algebraic sum of the moments in the anticlockwise direction. In other words, at

equilibrium, the algebraic sum of the moments of all the individual forces about any point is equal to zero.

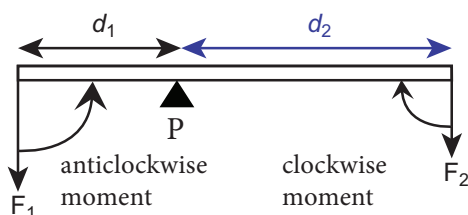

Figure 1.5 Principle of moments

In the illustration given in figure 1.5, the force  $F_1$  produces an anticlockwise rotation at a distance  $d_1$  from the point of pivot P (called fulcrum) and the force  $F_2$  produces a clockwise rotation at a distance  $d_2$  from the point of pivot P. The principle of moments can be written as follows:

Moment in clockwise direction = Moment in anticlockwise direction

$$F_1 \times d_1 = F_2 \times d_2 \dots\dots\dots (1.4)$$

### 1.5 NEWTON'S SECOND LAW OF MOTION

According to this law, “**the force acting on a body is directly proportional to the rate of change of linear momentum of the body and the change in momentum takes place in the direction of the force**”.

This law helps us to measure the amount of force. So, it is also called as ‘*law of force*’. Let, ‘ $m$ ’ be the mass of a moving body, moving along a straight line with an initial speed ‘ $u$ ’ After a time interval of ‘ $t$ ’, the velocity of the body changes to ‘ $v$ ’ due to the impact of an unbalanced external force  $F$ .

Initial momentum of the body  $P_i = mu$

Final momentum of the body  $P_f = mv$

Change in momentum  $\Delta p = P_f - P_i$   
 $= mv - mu$

By Newton’s second law of motion,

Force,  $F \propto$  rate of change of momentum

$F \propto$  change in momentum / time

$$F \propto \frac{mv - mu}{t}$$

$$F = \frac{km(v - u)}{t}$$

Here,  $k$  is the proportionality constant.  $k = 1$  in all systems of units. Hence,

$$F = \frac{m(v - u)}{t} \dots\dots\dots (1.5)$$

Since, acceleration = change in velocity/ time,  $a=(v-u)/t$ . Hence, we have

$$F = m \times a \dots\dots\dots (1.6)$$

Force = mass  $\times$  acceleration

No external force is required to maintain the motion of a body moving with uniform velocity. When the net force acting on a body is not equal to zero, then definitely the velocity of the body will change. Thus, change in momentum takes place in the direction of the force. The change may take place either in magnitude or in direction or in both.

Force is required to produce the acceleration of a body. In a uniform circular motion, even though the speed (magnitude of velocity) remains constant, the direction of the velocity changes at every point on the circular path. So, the acceleration is produced along the radius called as *centripetal acceleration*. The force, which produces this acceleration is called as centripetal force, about which you have learnt in class IX.

**Units of force:** SI unit of force is newton (N) and in C.G.S system its unit is dyne.

**Definition of 1 newton (N):** The amount of force required for a body of mass 1 kg produces an acceleration of  $1 \text{ m s}^{-2}$ ,  $1 \text{ N} = 1 \text{ kgms}^{-2}$

**Definition of 1 dyne:** The amount of force required for a body of mass 1 gram produces an acceleration of  $1 \text{ cm s}^{-2}$ ,  $1 \text{ dyne} = 1 \text{ gcms}^{-2}$ ; also  $1 \text{ N} = 10^5 \text{ dyne}$ .

**Unit force:**

The amount of force required to produce an acceleration of  $1 \text{ ms}^{-2}$  in a body of mass 1 kg is called 'unit force'.

**Gravitational unit of force:**

In the SI system of units, gravitational unit of force is kilogram force, represented by kg f. In the CGS system its unit is gram force, represented by g f.

$$1 \text{ kgf} = 1 \text{ kg} \times 9.8 \text{ ms}^{-2} = 9.8 \text{ N};$$

$$1 \text{ gf} = 1 \text{ g} \times 980 \text{ cms}^{-2} = 980 \text{ dyne}$$

**1.6 Impulse**

A large force acting for a very short interval of time is called as 'Impulsive force'. When a force  $F$  acts on a body for a period of time  $t$ , then the product of force and time is known as 'impulse' represented by 'J'

$$\text{Impulse, } J = F \times t \quad (1.7)$$

By Newton's second law

$$F = \Delta p / t \quad (\Delta \text{ refers to change})$$

$$\Delta p = F \times t \quad (1.8)$$

From 1.7 and 1.8

$$J = \Delta p$$

Impulse is also equal to the magnitude of change in momentum. Its unit is  $\text{kgms}^{-1}$  or  $\text{Ns}$ .

Change in momentum can be achieved in two ways. They are:

- i. a large force acting for a short period of time and
- ii. a smaller force acting for a longer period of time.

**Examples:**

- ◆ Automobiles are fitted with springs and shock absorbers to reduce jerks while moving on uneven roads.
- ◆ In cricket, a fielder pulls back his hands while catching the ball. He experiences a smaller force for a longer interval of time to catch the ball, resulting in a lesser impulse on his hands.



Figure 1.6 Example of impulsive force

**1.7 NEWTON'S THIRD LAW OF MOTION**

Newton's third law states that 'for every action, there is an equal and opposite reaction. They always act on two different bodies'.

If a body A applies a force  $F_A$  on a body B, then the body B reacts with force  $F_B$  on the body A, which is equal to  $F_A$  in magnitude, but opposite in direction.  $F_B = -F_A$

**Examples:**

- ◆ When birds fly they push the air downwards with their wings (Action) and the air pushes the bird upwards (Reaction).
- ◆ When a person swims he pushes the water using the hands backwards (Action), and the water pushes the swimmer in the forward direction (Reaction).
- ◆ When you fire a bullet, the gun recoils backward and the bullet is moving forward (Action) and the gun equalises this forward action by moving backward (Reaction).

**1.8 PRINCIPLE OF CONSERVATION OF LINEAR MOMENTUM**

There is no change in the linear momentum of a system of bodies as long as no net external force acts on them.



Let us prove the law of conservation of linear momentum with the following illustration:

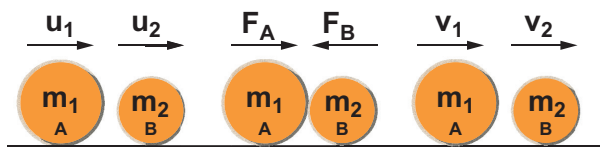

Figure 1.7 Conservation of linear momentum

**Proof:**

Let two bodies A and B having masses  $m_1$  and  $m_2$  move with initial velocity  $u_1$  and  $u_2$  in a straight line. Let the velocity of the first body be higher than that of the second body. i.e.,  $u_1 > u_2$ . During an interval of time  $t$  second, they tend to have a collision. After the impact, both of them move along the same straight line with a velocity  $v_1$  and  $v_2$  respectively.

Force on body B due to A,

$$F_A = m_2 (v_2 - u_2) / t$$

Force on body A due to B,

$$F_B = m_1 (v_1 - u_1) / t$$

By Newton's III law of motion,

Action force = Reaction force

$$F_B = -F_A$$

$$m_1 (v_1 - u_1) / t = -m_2 (v_2 - u_2) / t$$

$$m_1 v_1 + m_2 v_2 = m_1 u_1 + m_2 u_2 \text{ ----- (1.9)}$$

The above equation confirms **in the absence of an external force, the algebraic sum of the momentum after collision is numerically equal to sum of the momentum before collision.**

Hence the law of conservation linear momentum is proved.

**1.9 ROCKET PROPULSION**

Propulsion of rockets is based on the law of conservation of linear momentum as well as Newton's III law of motion. Rockets are

filled with a fuel (either liquid or solid) in the propellant tank. When the rocket is fired, this fuel is burnt and a hot gas is ejected with a high speed from the nozzle of the rocket, producing a huge momentum. To balance this momentum, an equal and opposite reaction force is produced in the combustion chamber, which makes the rocket project forward.

While in motion, the mass of the rocket gradually decreases, until the fuel is completely burnt out. Since, there is no net external force acting on it, the linear momentum of the system is conserved. The mass of the rocket decreases with altitude, which results in the gradual increase in velocity of the rocket. At one stage, it reaches a velocity, which is sufficient to just escape from the gravitational pull of the Earth. This velocity is called *escape velocity*. (This topic will be discussed in detail in higher classes).

**1.10 GRAVITATION**

**1.10.1 Newton's universal law of gravitation**

This law states that **every particle of matter in this universe attracts every other particle with a force. This force is directly proportional to the product of their masses and inversely proportional to the square of the distance between the centers of these masses. The direction of the force acts along the line joining the masses.**

Force between the masses is always attractive and it does not depend on the medium where they are placed.

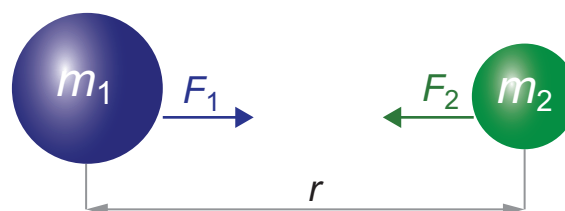

Figure 1.8 Gravitational force between two masses



Let,  $m_1$  and  $m_2$  be the masses of two bodies A and B placed  $r$  metre apart in space

$$\text{Force } F \propto m_1 \times m_2$$

$$F \propto 1/r^2$$

On combining the above two expressions

$$F \propto \frac{m_1 \times m_2}{r^2}$$

$$F = \frac{G m_1 m_2}{r^2} \dots\dots\dots(1.10)$$

Where  $G$  is the universal gravitational constant. Its value in SI unit is  $6.674 \times 10^{-11} \text{ Nm}^2\text{kg}^{-2}$ .

**1.10.2 Acceleration due to gravity (g)**

When you throw any object upwards, its velocity ceases at a particular height and then it falls down due to the gravitational force of the Earth.

The velocity of the object keeps changing as it falls down. This change in velocity must be due to the force acting on the object. The acceleration of the body is due to the Earth's gravitational force. So, it is called as 'acceleration due to the gravitational force of the Earth' or 'acceleration due to gravity of the Earth'. It is represented as 'g'. Its unit is  $\text{ms}^{-2}$

Mean value of the acceleration due to gravity is taken as  $9.8 \text{ m s}^{-2}$  on the surface of the Earth. This means that the velocity of a body during the downward free fall motion varies by  $9.8 \text{ ms}^{-1}$  for every 1 second. However, the value of 'g' is not the same at all points on the surface of the earth.

**1.10.3 Relation between g and G**

When a body is at rests on the surface of the Earth, it is acted upon by the gravitational force of the Earth. Let us compute the magnitude of this force in two ways. Let,  $M$  be the mass of the Earth and  $m$  be the mass of the body. The entire mass of the Earth is

assumed to be concentrated at its centre. The radius of the Earth is  $R = 6378 \text{ km}$  ( $= 6400 \text{ km}$  approximately). By Newton's law of gravitation, the force acting on the body is given by

$$F = \frac{G M m}{R^2} \dots\dots\dots(1.11)$$

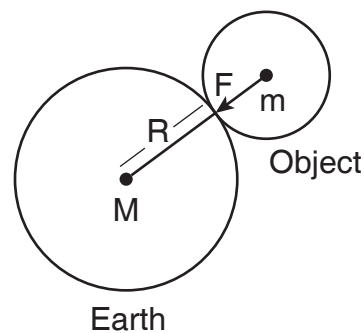

Figure 1.9 Relation between g and G

Here, the radius of the body considered is negligible when compared with the Earth's radius. Now, the same force can be obtained from Newton's second law of motion. According to this law, the force acting on the body is given by the product of its mass and acceleration (called as weight). Here, acceleration of the body is under the action of gravity hence  $a = g$

$$F = ma = mg$$

$$F = \text{weight} = mg \dots\dots\dots(1.12)$$

Comparing equations (1.7) and (1.8), we get

$$mg = \frac{GMm}{R^2} \dots\dots\dots(1.13)$$

Acceleration due to gravity

$$g = \frac{GM}{R^2} \dots\dots\dots(1.14)$$

**1.10.4 Mass of the Earth (M)**

Rearranging the equation (1.14), the mass of the Earth is obtained as follows:

$$\text{Mass of the Earth } M = g R^2/G$$

Substituting the known values of  $g$ ,  $R$  and  $G$ ,

you can calculate the mass of the Earth as

$$M = 5.972 \times 10^{24} \text{ kg}$$

### 1.10.5 Variation of acceleration due to gravity (g):

Since,  $g$  depends on the geometric radius of the Earth, ( $g \propto 1/R^2$ ), its value changes from one place to another on the surface of the Earth. Since, the geometric radius of the Earth is maximum in the equatorial region and minimum in the polar region, the value of  $g$  is maximum in the polar region and minimum at the equatorial region.

When you move to a higher altitude from the surface of the Earth, the value of  $g$  reduces. In the same way, when you move deep below the surface of the Earth, the value of  $g$  reduces. (This topic will be discussed in detail in the higher classes). Value of  $g$  is zero at the centre of the Earth.

### 1.11 MASS AND WEIGHT

**Mass:** Mass is the basic property of a body. Mass of a body is defined as the quantity of matter contained in the body. Its SI unit is kilogram (kg).

**Weight:** Weight of a body is defined as the gravitational force exerted on a body due to the gravity.

Weight = Gravitational Force  
 = mass ( $m$ )  $\times$  acceleration due to gravity ( $g$ ).

$g$  = acceleration due to gravity for Earth (at sea level) =  $9.8 \text{ ms}^{-2}$ .

Weight is a vector quantity. Direction of weight is always towards the centre of the Earth. SI unit of weight is newton (N). Weight of a body varies from one place to another place on the Earth since it depends on the acceleration due to gravity of the Earth ( $g$ ) weight of a body is more at the poles than at the equatorial region.

The value of acceleration due to gravity on the surface of the moon is  $1.625 \text{ ms}^{-2}$ .

This is about 0.1654 times the acceleration due to gravity of the Earth. If a person whose mass is 60 kg stands on the surface of Earth, his weight would be 588 N ( $W = mg = 60 \times 9.8$ ). If the same person goes to the surface of the Moon, he would weigh only 97.5 N ( $W = 60 \times 1.625$ ). But, his mass remains the same (60 kg) on both the Earth and the Moon.

### 1.12 APPARENT WEIGHT

The weight that you feel to possess during up and down motion, is not same as your actual weight. Apparent weight is the weight of the body acquired due to the action of gravity and other external forces acting on the body.

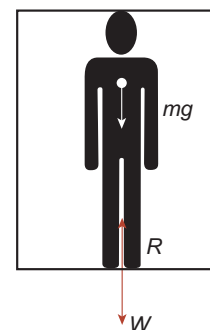

**Figure 1.10**  
 A person in a moving lift

Let us see this from the following illustration:

Let us consider a person of mass  $m$ , who is travelling in lift. The actual weight of the person is  $W = mg$ , which is acting vertically downwards. **The reaction force exerted by the lift's surface 'R', taken as apparent weight is acting vertically upwards.**

Let us see different possibilities of the apparent weight 'R' of the person that arise, depending on the motion of the lift; upwards or downwards which are given in Table 1.2

#### 1.12.1 Weightlessness

Have you gone to an amusement park and taken a ride in a roller coaster? or in a giant wheel? During the fast downward and upward movement, how did you feel?



**Table 1.2** Apparent weight of a person in a moving lift

Case 1: Lift is moving <b>upward</b> with an acceleration 'a'	Case 2: Lift is moving <b>downward</b> with an acceleration 'a'	Case 3: Lift is at <b>rest</b> .	Case 4: Lift is <b>falling down freely</b>
$R - W = F_{\text{net}} = ma$ $R = W + ma$ $R = mg + ma$ $R = m(g+a)$	$W - R = F_{\text{net}} = ma$ $R = W - ma$ $R = mg - ma$ $R = m(g-a)$	Here, the acceleration is zero $a = 0$ $R = W$ $R = mg$	Here, the acceleration is equal to g $a = g$ $R = m(g - g)$
$R > W$	$R < W$	$R = W$	$R = 0$
Apparent weight is <b>greater</b> than the actual weight.	Apparent weight is <b>lesser</b> than the actual weight.	Apparent weight is <b>equal</b> to the actual weight.	Apparent weight is equal to <b>zero</b> .



**Figure 1.11** Weightlessness in a roller coaster

Its amazing!! You actually feel as if you are falling freely without having any weight. This is due to the phenomenon of 'weightlessness'. You seem to have lost your weight when you move down with a certain acceleration. Sometimes, you experience the same feeling while travelling in a lift.

When the person in a lift moves down with an acceleration (a) equal to the acceleration due to gravity (g), i.e., when  $a = g$ , this motion is called as 'free fall'. Here, the apparent weight ( $R = m(g - g) = 0$ ) of the person is zero. This condition or state refers to the state of weightlessness. (Refer case 4 from Table 1.2).

The same effect takes place while falling freely in a roller coaster or on a swing or in a vertical giant wheel. You feel an apparent weight

loss and weight gain when you are moving up and down in such rides.

### 1.12.2 Weightlessness of the astronauts

Some of us believe that the astronauts in the orbiting spacestation do not experience any gravitational force of the Earth. So they float. But this is absolutely wrong.

Astronauts are not floating but falling freely around the earth due to their huge orbital velocity. Since spacestation and astronauts have equal acceleration, they are under free fall condition. ( $R = 0$  refer case 4 in Table 1.2). Hence, both the astronauts and the spacestation are in the state of weightlessness.

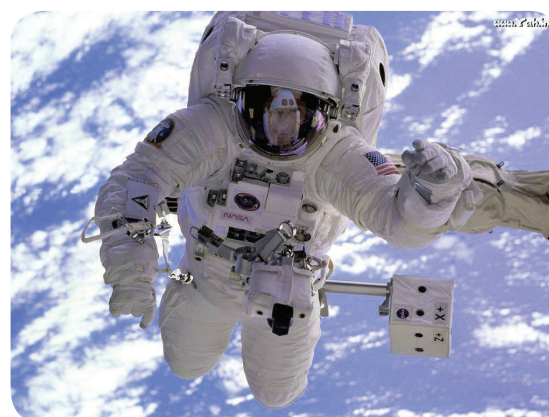

**Figure 1.12** Weightlessness of astronauts

**1.12.3 Application of Newton's law of gravitation**

- 1) Dimensions of the heavenly bodies can be measured using the gravitation law. Mass of the Earth, radius of the Earth, acceleration due to gravity, etc. can be calculated with a higher accuracy.
- 2) Helps in discovering new stars and planets.
- 3) One of the irregularities in the motion of stars is called 'Wobble' lead to the disturbance in the motion of a planet nearby. In this condition the mass of the star can be calculated using the law of gravitation.
- 4) Helps to explain germination of roots is due to the property of geotropism which is the property of a root responding to the gravity.
- 5) Helps to predict the path of the astronomical bodies.

**Points to Remember**

- ❖ Mechanics is divided into statics and dynamics.
- ❖ Ability of a body to maintain its state of rest or motion is called Inertia.
- ❖ Moment of the couple is measured by the product of any one of the forces and the perpendicular distance between two forces.
- ❖ SI unit of force is newton (N). C.G.S unit is dyne.
- ❖ When a force F acts on a body for a period of time t, then the product of force and time is known as 'impulse'.
- ❖ The unit of weight is newton or kg f
- ❖ The weight of a body is more at the poles than at the equatorial region.
- ❖ Mass of a body is defined as the quantity of matter contained in the object. Its SI unit is kilogram (kg).
- ❖ Apparent weight is the weight of the body acquired due to the action of gravity and other external forces on the body.

- ❖ Whenever a body or a person falls freely under the action of Earth's gravitational force alone, it appears to have zero weight. This state is referred to as 'weightlessness'.

**SOLVED PROBLEMS**

**Problem-1:** Calculate the velocity of a moving body of mass 5 kg whose linear momentum is  $2.5 \text{ kg m s}^{-1}$ .

**Solution:** Linear momentum = mass  $\times$  velocity

$$\text{Velocity} = \text{linear momentum} / \text{mass.}$$

$$V = 2.5 / 5 = 0.5 \text{ ms}^{-1}$$

**Problem 2:** A door is pushed, at a point whose distance from the hinges is 90 cm, with a force of 40 N. Calculate the moment of the force about the hinges.

**Solution:**

**Formula:** The moment of a force  $M = F \times d$

Given:  $F = 40 \text{ N}$  and  $d = 90 \text{ cm} = 0.9 \text{ m}$ .

Hence, moment of the force =  $40 \times 0.9 = 36 \text{ N m}$ .

**Problem 3 :** At what height from the centre of the Earth the acceleration due to gravity will be  $\frac{1}{4}$ <sup>th</sup> of its value as at the Earth.

**Solution:**

**Data:** Height from the centre of the Earth,  $R' = R + h$

The acceleration due to gravity at that height,  $g' = g/4$

**Formula:**  $g = GM / R^2$ ,  $g' = GM / R'^2$

$$\frac{g}{g'} = \left(\frac{R'}{R}\right)^2 = \left(\frac{R+h}{R}\right)^2 = \left(1 + \frac{h}{R}\right)^2$$

$$4 = \left(1 + \frac{h}{R}\right)^2,$$

$$2 = 1 + \frac{h}{R} \quad \text{or } h = R. \quad R' = 2R$$

From the centre of the Earth, the object is placed at twice the radius of the earth.



## TEXTBOOK EVALUATION



### I. Choose the correct answer

- Inertia of a body depends on
  - weight of the object
  - acceleration due to gravity of the planet
  - mass of the object
  - Both a & b
- Impulse is equals to
  - rate of change of momentum
  - rate of force and time
  - change of momentum
  - rate of change of mass
- Newton's III law is applicable
  - for a body is at rest
  - for a body in motion
  - both a & b
  - only for bodies with equal masses
- Plotting a graph for momentum on the Y-axis and time on X-axis. slope of momentum-time graph gives
  - Impulsive force
  - Acceleration
  - Force
  - Rate of force
- In which of the following sport the turning of effect of force used
  - swimming
  - tennis
  - cycling
  - hockey
- The unit of 'g' is  $\text{m s}^{-2}$ . It can be also expressed as
  - $\text{cms}^{-1}$
  - $\text{Nkg}^{-1}$
  - $\text{Nm}^2\text{kg}^{-1}$
  - $\text{cm}^2\text{s}^{-2}$
- One kilogram force equals to
  - 9.8 dyne
  - $9.8 \times 10^4 \text{ N}$
  - $98 \times 10^4 \text{ dyne}$
  - 980 dyne
- The mass of a body is measured on planet Earth as M kg. When it is taken to a planet of radius half that of the Earth then its value will be \_\_\_kg
  - 4 M
  - 2M
  - M/4
  - M
- If the Earth shrinks to 50% of its real radius its mass remaining the same, the weight of a body on the Earth will
  - decrease by 50%
  - increase by 50%
  - decrease by 25%
  - increase by 300%
- To project the rockets which of the following principle(s) is /(are) required?
  - Newton's third law of motion
  - Newton's law of gravitation
  - law of conservation of linear momentum
  - both a and c

### II. Fill in the blanks

- To produce a displacement \_\_\_\_\_ is required
- Passengers lean forward when sudden brake is applied in a moving vehicle. This can be explained by \_\_\_\_\_
- By convention, the clockwise moments are taken as \_\_\_\_\_ and the anticlockwise moments are taken as \_\_\_\_\_
- \_\_\_\_\_ is used to change the speed of car.
- A man of mass 100 kg has a weight of \_\_\_\_\_ at the surface of the Earth

### III. State whether the following statements are true or false. Correct the statement if it is false

- The linear momentum of a system of particles is always conserved.
- Apparent weight of a person is always equal to his actual weight
- Weight of a body is greater at the equator and less at the polar region.
- Turning a nut with a spanner having a short handle is so easy than one with a long handle.
- There is no gravity in the orbiting space station around the Earth. So the astronauts feel weightlessness.

**IV. Match the following**

Column I	Column II
a. Newton's I law	- propulsion of a rocket
b. Newton's II law	- Stable equilibrium of a body
c. Newton's III law	- Law of force
d. Law of conservation of Linear momentum	- Flying nature of bird

**V. Assertion & Reasoning**

Mark the correct choice as

- (a) If both the assertion and the reason are true and the reason is the correct explanation of assertion.
- (b) If both the assertion and the reason are true, but the reason is not the correct explanation of the assertion.
- (c) Assertion is true, but the reason is false.
- (d) Assertion is false, but the reason is true.

**1. Assertion:** The sum of the clockwise moments is equal to the sum of the anticlockwise moments.

**Reason:** The principle of conservation of momentum is valid if the external force on the system is zero.

**2. Assertion:** The value of 'g' decreases as height and depth increases from the surface of the Earth.

**Reason:** 'g' depends on the mass of the object and the Earth.

**VI. Answer briefly.**

1. Define inertia. Give its classification.
2. Classify the types of force based on their application.
3. If a 5 N and a 15 N forces are acting opposite to one another. Find the resultant force and the direction of action of the resultant force
4. Differentiate mass and weight.
5. Define moment of a couple.

6. State the principle of moments.
7. State Newton's second law.
8. Why a spanner with a long handle is preferred to tighten screws in heavy vehicles?
9. While catching a cricket ball the fielder lowers his hands backwards. Why?
10. How does an astronaut float in a space shuttle?

**VII. Solve the given problems**

1. Two bodies have a mass ratio of 3:4 The force applied on the bigger mass produces an acceleration of  $12 \text{ ms}^{-2}$ . What could be the acceleration of the other body, if the same force acts on it.
2. A ball of mass 1 kg moving with a speed of  $10 \text{ ms}^{-1}$  rebounds after a perfect elastic collision with the floor. Calculate the change in linear momentum of the ball.
3. A mechanic unscrew a nut by applying a force of 140 N with a spanner of length 40 cm. What should be the length of the spanner if a force of 40 N is applied to unscrew the same nut?
4. The ratio of masses of two planets is 2:3 and the ratio of their radii is 4:7 Find the ratio of their accelerations due to gravity.

**VIII. Answer in detail.**

1. What are the types of inertia? Give an example for each type.
2. State Newton's laws of motion?
3. Deduce the equation of a force using Newton's second law of motion.
4. State and prove the law of conservation of linear momentum.
5. Describe rocket propulsion.
6. State the universal law of gravitation and derive its mathematical expression
7. Give the applications of universal law gravitation.

**IX. HOT Questions**

- Two blocks of masses 8 kg and 2 kg respectively lie on a smooth horizontal surface in contact with one other. They are pushed by a horizontally applied force of 15 N. Calculate the force exerted on the 2 kg mass.
- A heavy truck and bike are moving with the same kinetic energy. If the mass of the truck is four times that of the bike, then calculate the ratio of their momenta. (Ratio of momenta = 2:1)
- “Wearing helmet and fastening the seat belt is highly recommended for safe journey” Justify your answer using Newton’s laws of motion.



**REFERENCE BOOKS**

- ◆ Concept of physics-HC verma
- ◆ Interactive physics(Newton’s law)MTG learning.



**INTERNET RESOURCES**

- <https://www.grc.nasa.gov>
- <https://www.physicsclassroom.com>
- <https://www.britannica.com/science/Newtons-law-of-gravitation>

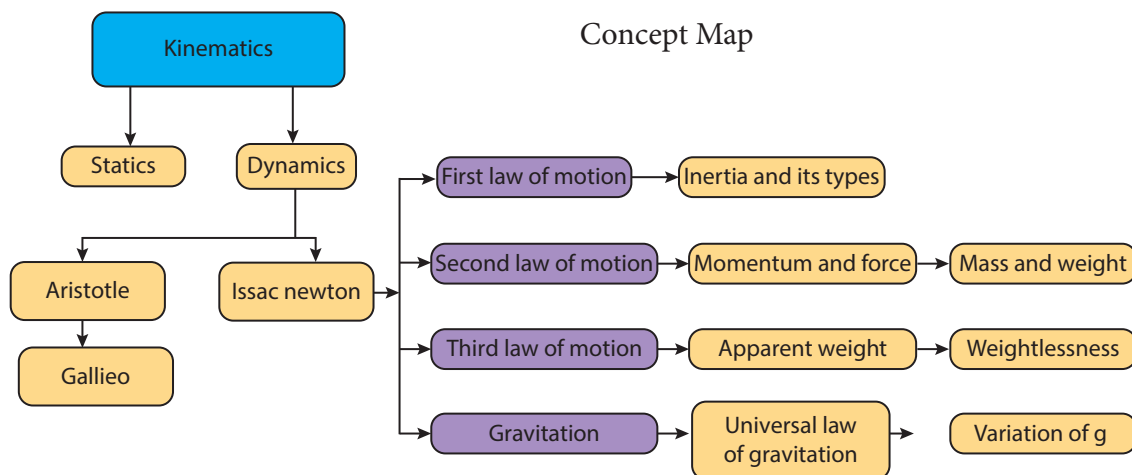

**ICT CORNER**

**Newton’s second law**

**Steps**

- Open the browser and type “olabs.edu.in” in the address bar. Click physics tab and then click “Newton’s second” under class 9 section. Go to “simulator” tab to do the experiment.
- Select the desired Cart mass ( $M_1$ ) and vertical mass ( $M_2$ ) using respective slider. Also select the desired distance (s) by moving the slider. Click on the “Start” button to start the experiment.
- Observe the time and note it down. Calculate acceleration (a) of the cart using the formula  $a = 2s/t^2$ . Find the fore due to rate of change of momentum using  $(M_1+M_2) a$ .
- Calculate force  $F = M_2 g$ .
- You will observe  $(M_1+M_2)a = M_2 g$ . Hence Newton’s Second Law is verified. Repeat the experiment with different masses. Also do this in different environment like Earth, Moon, Uranus and Jupiter. Click reset to restart the experiment.

Link: <http://amrita.olabs.edu.in/?sub=1&brch=1&sim=44&cnt=4>





## OPTICS



## Learning Objectives

At the end of this lesson, students will be able to:

- ◆ state the laws of refraction.
- ◆ list the properties of light.
- ◆ explain the scattering of light and its various kinds.
- ◆ understand the images formed by concave and convex lens.
- ◆ analyze the ray diagram of concave and convex lens.
- ◆ understand the working of human eye and optical instruments
- ◆ solve numerical problems



5JCII2

## INTRODUCTION

Light is a form of energy which travels in the form of waves. The path of light is called ray of light and group of these rays are called as beam of light. Any object which gives out light are termed as source of light. Some of the sources emit their own light and they are called as luminous objects. All the stars, including the Sun, are examples for luminous objects. We all know that we are able to see objects with the help of our eyes. But, we cannot see any object in a dark room. Can you explain why? If your answer is 'we need light to see objects', the next question is 'if you make the light from a torch to fall on your eyes, will you be able to see the objects?' Definitely, 'NO'. We can see the objects only when the light is made to fall on the objects and the light reflected from the objects is viewed by our eyes. You would have studied about the reflection and refraction of light elaborately in your previous classes. In this

chapter, we shall discuss about the scattering of light, images formed by convex and concave lenses, human eye and optical instruments such as telescopes and microscopes.

## 2.1 PROPERTIES OF LIGHT

Let us recall the properties of light and the important aspects on refraction of light.

1. Light is a form of energy.
2. Light always travels along a straight line.
3. Light does not need any medium for its propagation. It can even travel through vacuum.
4. The speed of light in vacuum or air is,  $c = 3 \times 10^8 \text{ ms}^{-1}$ .
5. Since, light is in the form of waves, it is characterized by a wavelength ( $\lambda$ ) and a frequency ( $\nu$ ), which are related by the following equation:  $c = \nu \lambda$  ( $c$  - velocity of light).



6. Different coloured light has different wavelength and frequency.
7. Among the visible light, violet light has the lowest wavelength and red light has the highest wavelength.
8. When light is incident on the interface between two media, it is partly reflected and partly refracted.

- ◆ When light travels from a rarer medium into a denser medium, the refracted ray is bent towards the normal drawn to the interface.

## 2.2 REFRACTION OF LIGHT

When a ray of light travels from one transparent medium into another obliquely, the path of the light undergoes deviation. This deviation of ray of light is called refraction. Refraction takes place due to the difference in the velocity of light in different media. The velocity of light is more in a rarer medium and less in a denser medium. Refraction of light obeys two laws of refraction.

### 2.2.1 First law of refraction:

The incident ray, the refracted ray of light and the normal to the refracting surface all lie in the same plane.

### 2.2.2 Second law of refraction:

The ratio of the sine of the angle of incidence and sine of the angle of refraction is equal to the ratio of refractive indices of the two media. This law is also known as Snell's law.

$$\frac{\sin i}{\sin r} = \frac{\mu_2}{\mu_1} \dots\dots\dots (2.1)$$

- ◆ Refractive index gives us an idea of how fast or how slow light travels in a medium. The ratio of speed of light in vacuum (c) to the speed of light in a medium (v) is defined as refractive index 'μ' of that medium.

$$\mu = \frac{c}{v}$$

- ◆ The speed of light in a medium is low if the refractive index of the medium is high and vice versa.
- ◆ When light travels from a denser medium into a rarer medium, the refracted ray is bent away from the normal drawn to the interface.

## 2.3 REFRACTION OF A COMPOSITE LIGHT-DISPERSION OF LIGHT

We know that Sun is the fundamental and natural source of light. If a source of light produces a light of single colour, it is known as a monochromatic source. On the other hand, a composite source of light produces a white light which contains light of different colours. Sun light is a composite light which consists of light of various colours or wavelengths. Another example for a composite source is a mercury vapour lamp. What do you observe when a white light is refracted through a glass prism?

When a beam of white light or composite light is refracted through any transparent media such as glass or water, it is split into its component colours. This phenomenon is called as 'dispersion of light'.

The band of colours is termed as spectrum. This spectrum consists of following colours: Violet, Indigo, Blue, Green, Yellow, Orange, and Red. These colours are represented by the acronym "VIBGYOR". Why do we get the spectrum when white light is refracted by a transparent medium? This is because, different coloured lights are bent through different angles. That is the angle of refraction is different for different colours.

Angle of refraction is the smallest for red and the highest for violet. From Snell's law, we know that the angle of refraction is determined in terms of the refractive index of the medium. Hence, the refractive index of the medium is different for different coloured lights. This indicates that the refractive index of a medium is dependent on the wavelength of the light.

## 2.4 SCATTERING OF LIGHT

When sunlight enters the Earth's atmosphere, the atoms and molecules of different gases present in the atmosphere refract the light in all possible directions. This is called as 'Scattering of light'. In this phenomenon, the beam of light is redirected in all directions when it interacts with a particle of medium. The interacting particle of the medium is called as 'scatterer'.

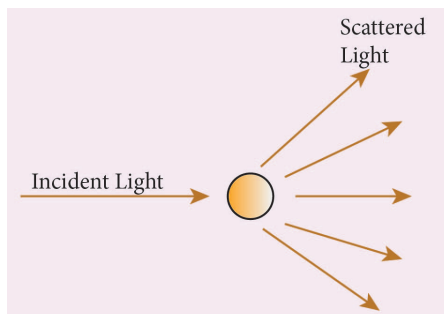

**Figure 2.1** Scattering of light

### 2.4.1 Types of scattering

When a beam of light, interacts with a constituent particle of the medium, it undergoes many kinds of scattering. Based on initial and final energy of the light beam, scattering can be classified as,

- 1) Elastic scattering
- 2) Inelastic scattering

#### 1) Elastic scattering

If the energy of the incident beam of light and the scattered beam of light are same, then it is called as 'elastic scattering'.

#### 2) Inelastic scattering

If the energy of the incident beam of light and the scattered beam of light are not same, then it is called as 'inelastic scattering'. The nature and size of the scatterer results in different types of scattering. They are

- Rayleigh scattering
- Mie scattering
- Tyndall scattering
- Raman scattering

### Rayleigh scattering

The scattering of sunlight by the atoms or molecules of the gases in the earth's atmosphere is known as Rayleigh scattering.

### Rayleigh's scattering law

Rayleigh's scattering law states that, "The amount of scattering of light is inversely proportional to the fourth power of its wavelength".

$$\text{Amount of scattering 'S'} \propto \frac{1}{\lambda^4}$$

According to this law, the shorter wavelength colours are scattered much more than the longer wavelength colours.

When sunlight passes through the atmosphere, the blue colour (shorter wavelength) is scattered to a greater extent than the red colour (longer wavelength). This scattering causes the sky to appear in blue colour.

At sunrise and sunset, the light rays from the Sun have to travel a larger distance in the atmosphere than at noon. Hence, most of the blue lights are scattered away and only the red light which gets least scattered reaches us. Therefore, the colour of the Sun is red at sunrise and sunset.

### Mie scattering

Mie scattering takes place when the diameter of the scatterer is similar to or larger than the wavelength of the incident light. It is also an elastic scattering. The amount of scattering is independent of wave length.

Mie scattering is caused by pollen, dust, smoke, water droplets, and other particles in the lower portion of the atmosphere.

Mie scattering is responsible for the white appearance of the clouds. When white light falls on the water drop, all the colours are equally scattered which together form the white light.

## Tyndall Scattering

When a beam of sunlight, enters into a dusty room through a window, then its path becomes visible to us. This is because, the tiny dust particles present in the air of the room scatter the beam of light. This is an example of Tyndall Scattering

The scattering of light rays by the colloidal particles in the colloidal solution is called Tyndall Scattering or Tyndall Effect.

### Do you Know

**Colloid** is a microscopically small substance that is equally dispersed throughout another material. Example: Milk, Ice cream, muddy water, smoke

## Raman scattering

When a parallel beam of monochromatic (single coloured ) light passes through a gas or liquid or transparent solid, a part of light rays are scattered.

The scattered light contains some additional frequencies (or wavelengths) other than that of incident frequency (or wavelength). This is known as Raman scattering or Raman Effect.

Raman Scattering is defined as *“The interaction of light ray with the particles of pure liquids or transparent solids, which leads to a change in wavelength or frequency.”*

The spectral lines having frequency equal to the incident ray frequency is called ‘Rayleigh line’ and the spectral lines which are having frequencies other than the incident ray frequency are called ‘Raman lines’. The lines having frequencies lower than the incident frequency is called stokes lines and the lines having frequencies higher than the incident frequency are called Antistokes lines.

You will study more about Raman Effect in higher classes.

## 2.5 LENSES

A lens is an optically transparent medium bounded by two spherical refracting surfaces or one plane and one spherical surface.

Lens is basically classified into two types. They are: (i) Convex Lens (ii) Concave Lens

- (i) **Convex or bi-convex lens:** It is a lens bounded by two spherical surfaces such that it is thicker at the centre than at the edges. A beam of light passing through it, is converged to a point. So, a convex lens is also called as converging lens.
- (ii) **Concave or bi-concave Lens:** It is a lens bounded by two spherical surfaces such that it is thinner at the centre than at the edges. A parallel beam of light passing through it, is diverged or spread out. So, a concave lens is also called as diverging lens.

### 2.5.1 Other types of Lenses

**Plano-convex lens:** If one of the faces of a bi-convex lens is plane, it is known as a plano-convex lens.

**Plano-concave lens:** If one of the faces of a bi-concave lens is plane, it is known as a plano-concave lens.

All these lenses are shown in Figure 2.2 given below:

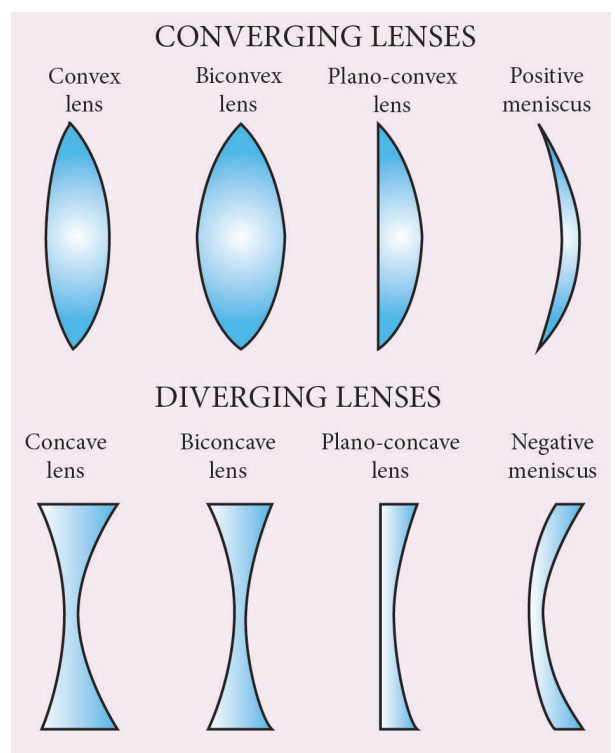
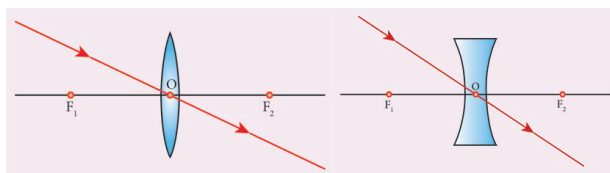

Figure 2.2 Types of lenses

## 2.6 IMAGES FORMED DUE TO REFRACTION THROUGH A CONVEX AND CONCAVE LENS

When an object is placed in front of a lens, the light rays from the object fall on the lens. The position, size and nature of the image formed can be understood only if we know certain basic rules.

**Rule-1:** When a ray of light strikes the convex or concave lens obliquely at its optical centre, it continues to follow its path without any deviation (Figure 2.3).



**Figure 2.3** Rays passing through the optical centre

**Rule-2:** When rays parallel to the principal axis strikes a convex or concave lens, the refracted rays are converged to (convex lens) or appear to diverge from (concave lens) the principal focus (Figure 2.4).

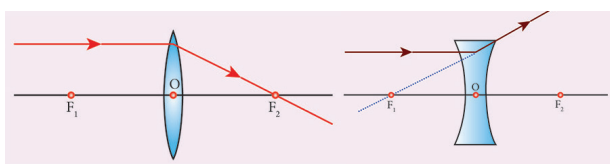

**Figure 2.4** Rays passing parallel to the optic axis

**Rule-3:** When a ray passing through (convex lens) or directed towards (concave lens) the principal focus strikes a convex or concave lens, the refracted ray will be parallel to the principal axis (Figure 2.5).

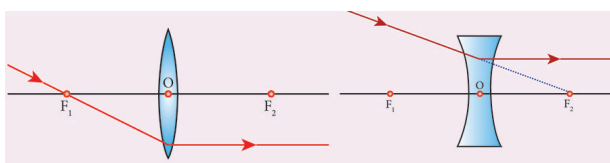

**Figure 2.5** Rays passing through or directed towards the principal focus

## 2.7 REFRACTION THROUGH A CONVEX LENS

Let us discuss the formation of images by a convex lens when the object is placed at various positions.



### Object at infinity

When an object is placed at infinity, a real image is formed at the principal focus. The size of the image is much smaller than that of the object (Figure 2.6).

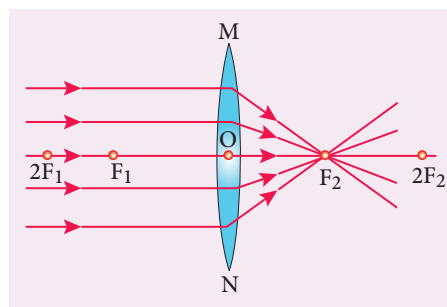

**Figure 2.6** Object at infinity

### Object placed beyond C (>2F)

When an object is placed behind the center of curvature (beyond C), a real and inverted image is formed between the center of curvature and the principal focus. The size of the image is smaller than that of the object (Figure 2.7).

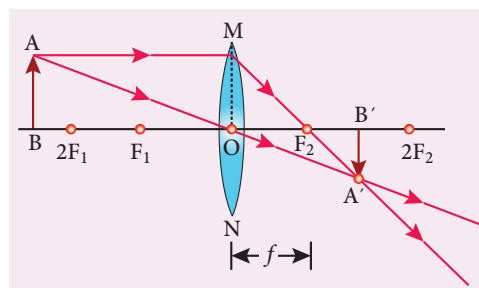

**Figure 2.7** Object placed beyond C (>2F)

### Object placed at C

When an object is placed at the center of curvature, a real and inverted image is formed at the other center of curvature. The size of the image is the same as that of the object (Figure 2.8).

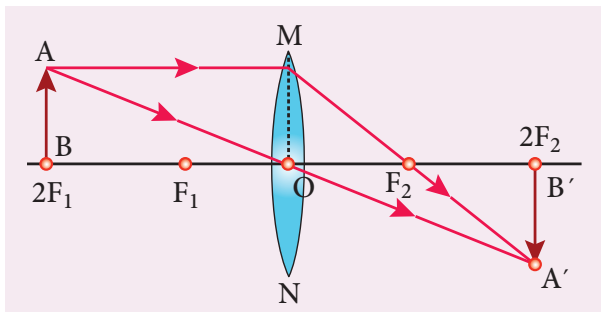

Figure.2.8 Object placed at C

### Object placed between F and C

When an object is placed in between the center of curvature and principal focus, a real and inverted image is formed behind the center of curvature. The size of the image is bigger than that of the object (Figure 2.9).

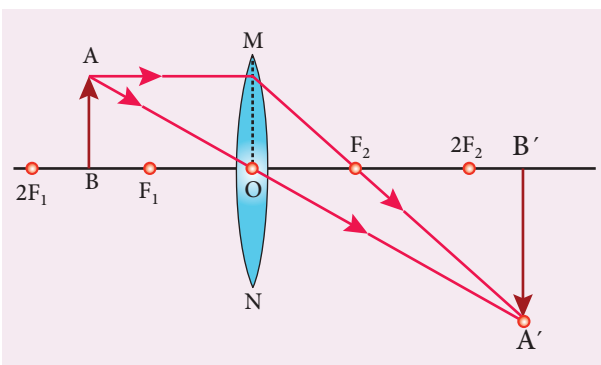

Figure 2.9 Object placed between F and C

### Object placed at the principal focus F

When an object is placed at the focus, a real image is formed at infinity. The size of the image is much larger than that of the object (Figure 2.10).

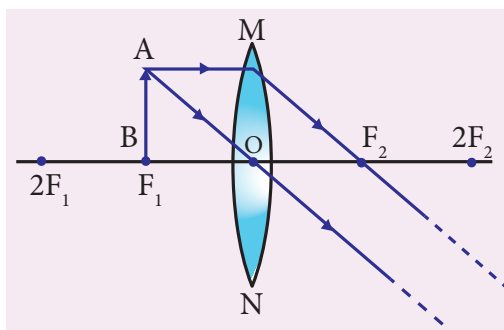

Figure 2.10 Object placed at the principal focus F

### Object placed between the principal focus F and optical centre O

When an object is placed in between principal focus and optical centre, a virtual image is formed. The size of the image is larger than that of the object (Figure 2.11).

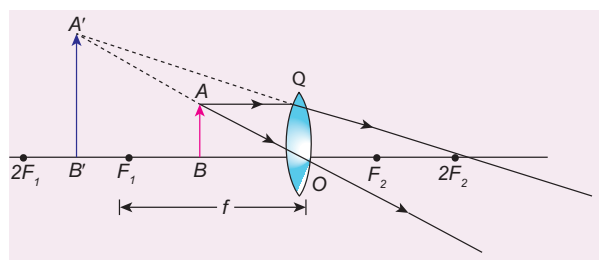

Figure 2.11 Object placed between the principal focus F and optical centre O

## 2.8 APPLICATIONS OF CONVEX LENSES

1. Convex lenses are used as camera lenses
2. They are used as magnifying lenses
3. They are used in making microscope, telescope and slide projectors
4. They are used to correct the defect of vision called hypermetropia

## 2.9 REFRACTION THROUGH A CONCAVE LENS

Let us discuss the formation of images by a concave lens when the object is placed at two possible positions.

### Object at Infinity

When an object is placed at infinity, a virtual image is formed at the focus. The size of the image is much smaller than that of the object (Figure 2.12).

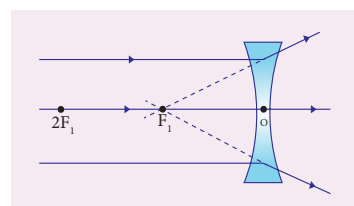

Figure 2.12 Concave lens-Object at infinity

### Object anywhere on the principal axis at a finite distance

When an object is placed at a finite distance from the lens, a virtual image is formed between optical center and focus of the concave lens. The size of the image is smaller than that of the object (Figure 2.13).

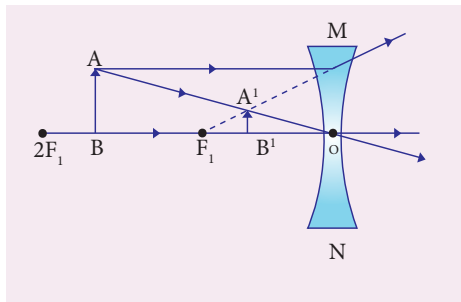

Figure 2.13 Concave lens-Object at a finite distance

But, as the distance between the object and the lens is decreased, the distance between the image and the lens also keeps decreasing. Further, the size of the image formed increases as the distance between the object and the lens is decreased. This is shown in (figure 2.14).

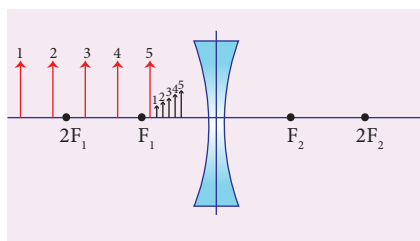

Figure 2.14 Concave lens-Variation in position and size of image with object distance

### 2.10 APPLICATIONS OF CONCAVE LENSES

1. Concave lenses are used as eye lens of 'Galilean Telescope'
2. They are used in wide angle spy hole in doors.
3. They are used to correct the defect of vision called 'myopia'

### 2.11 LENS FORMULA

Like spherical mirrors, we have lens formula for spherical lenses. The lens formula gives the relationship among distance of the object ( $u$ ), distance of the image ( $v$ ) and the focal length ( $f$ ) of the lens. It is expressed as

$$\frac{1}{f} = \frac{1}{v} - \frac{1}{u} \dots \dots \dots 2.2$$

It is applicable to both convex and concave lenses. We need to give an at most care while solving numerical problems related to lenses in taking proper signs of different quantities.

### 2.12 SIGN CONVENTION

Cartesian sign conventions are used for measuring the various distances in the ray diagrams of spherical lenses. According to cartesian sign convention,

1. The object is always placed on the left side of the lens.
2. All the distances are measured from the optical centre of the lens.
3. The distances measured in the same direction as that of incident light are taken as positive.
4. The distances measured against the direction of incident light are taken as negative.
5. The distances measured upward and perpendicular to the principal axis is taken as positive.
6. The distances measured downward and perpendicular to the principal axis is taken as negative.

### 2.13 MAGNIFICATION OF A LENS

Like spherical mirrors, we have magnification for spherical lenses. Spherical lenses produce magnification and it is defined as the ratio of the height of the image to the

height of an object. Magnification is denoted by the letter 'm'. If height of the object is  $h$  and height of the image is  $h'$ , the magnification produced by lens is,

$$m = \frac{\text{height of the image}}{\text{height of the object}} = \frac{h'}{h} \dots\dots (2.3)$$

Also it is related to the distance of the object ( $u$ ) and the distance of the image ( $v$ ) as follows:

$$m = \frac{\text{Distance of the image}}{\text{Distance of the object}} = \frac{v}{u} \dots\dots (2.4)$$

If the magnification is greater than 1, then we get an enlarged image. On the other hand, if the magnification is less than 1, then we get a diminished image.

**2.14 LENS MAKER'S FORMULA**

All lenses are made up of transparent materials. Any optically transparent material will have a refractive index. The lens formula relates the focal length of a lens with the distance of object and image. For a maker of any lens, knowledge of radii of curvature of the lens is required. This clearly indicates the need for an equation relating the radii of curvature of the lens, the refractive index of the given material of the lens and the required focal length of the lens. The lens maker's formula is one such equation. It is given as

$$\frac{1}{f} = (\mu - 1) \left( \frac{1}{R_1} - \frac{1}{R_2} \right) \dots\dots\dots (2.5)$$

where  $\mu$  is the refractive index of the material of the lens;  $R_1$  and  $R_2$  are the radii of curvature of the two faces of the lens;  $f$  is the focal length of the lens.

**2.15 POWER OF A LENS**

When a ray of light falls on a lens, the ability to converge or diverge these light rays depends on the focal length of the lens. This ability of a lens to converge (convex lens) or diverge (concave lens) is called as its power. Hence, the power of a lens can be defined as the degree of convergence or divergence of light rays. Power of a lens is numerically defined as the reciprocal of its focal length.

$$P = \frac{1}{f} \dots\dots\dots (2.6)$$

The SI unit of power of a lens is dioptre. It is represented by the symbol  $D$ . If focal length is expressed in 'm', then the power of lens is expressed in 'D'. Thus 1D is the power of a lens, whose focal length is 1metre.  $1D = 1m^{-1}$ .

By convention, the power of a convex lens is taken as positive whereas the power of a concave lens is taken, as negative.

**More to Know**

The lens formula and lens maker's formula are applicable to only thin lenses. In the case of thick lenses, these formulae with little modifications are used.

**Table 2.1** Differences between a Convex Lens and a Concave Lens

S. No	Convex Lens	Concave Lens
1	A convex lens is thicker in the middle than at edges.	A concave lens is thinner in the middle than at edges.
2	It is a converging lens.	It is a diverging lens.
3	It produces mostly real images.	It produces virtual images.
4	It is used to treat hypermeteropia.	It is used to treat myopia.

## 2.16 HUMAN EYE

The human eyes are most valuable and sensitive organs responsible for vision. They are the gateway to the wonderful world.

### Structure of the eye

The eye ball is approximately spherical in shape with a diameter of about 2.3 cm. It consists of a tough membrane called sclera, which protects the internal parts of the eye.

Important parts of human eye are

**Cornea:** This is the thin and transparent layer on the front surface of the eyeball as shown in figure 2.15. It is the main refracting surface. When light enters through the cornea, it refracts or bends the light on to the lens.

**Iris:** It is the coloured part of the eye. It may be blue, brown or green in colour. Every person has a unique colour, pattern and texture. Iris controls amount of light entering into the pupil like camera aperture.

**Pupil:** It is the centre part of the Iris. It is the pathway for the light to retina.

**Retina:** This is the back surface of the eye. It is the most sensitive part of human eye, on which real and inverted image of objects is formed.

**Eye Lens** – It is the important part of human eye. It is convex in nature.

**Ciliary muscles** – Eye lens is fixed between the ciliary muscles. It helps to change the focal length of the eye lens according to the position of the object.

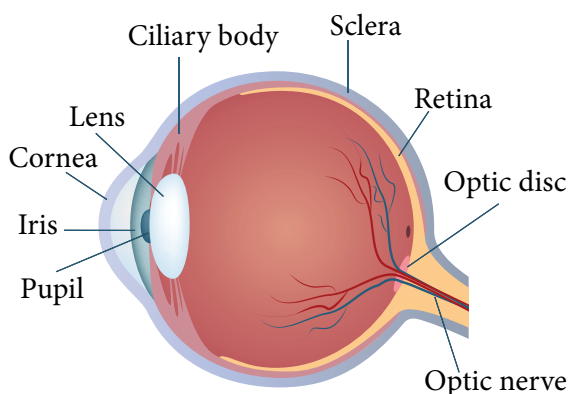

Figure 2.15 Human eye

### Working of the eye

The transparent layer cornea bends the light rays through pupil located at the centre part of the Iris. The adjusted light passes through the eye lens. Eye lens is convex in nature. So, the light rays from the objects are converged and a real and inverted image is formed on retina. Then, retina passes the received real and inverted image to the brain through optical nerves. Finally, the brain senses it as erect image.

### Power of Accommodation

The ability of the eye lens to focus nearby as well as the distant objects is called power of accommodation of the eye. This is achieved by changing the focal length of the eye lens with the help of ciliary muscles.

Eye lens is made of a flexible, jelly-like material. By relaxing and contracting the ciliary muscle, the curvature and hence the focal length of the eye lens can be altered. When we see distant objects, the ciliary muscle relaxes and makes the eye lens thinner. This increases the focal length of the eye lens. Hence, the distant object can be clearly seen. On the other hand, when we look at a closer object, the focal length of the eye lens is decreased by the contraction of ciliary muscle. Thus, the image of the closer object is clearly formed on the retina.

### Persistence of vision

If the time interval between two consecutive light pulses is less than  $\frac{1}{16}$  second, human eye cannot distinguish them separately. It is called persistence of vision.

### The far point and near point of the human eye

The minimum distance required to see the objects distinctly without strain is called least distance of distinct vision. It is called as near point of eye. It is 25 cm for normal human eye.



The maximum distance up to which the eye can see objects clearly is called as far point of the eye. It is infinity for normal eye.

### 2.17 DEFECTS IN EYE

A normal human eye can clearly see all the objects placed between 25cm and infinity. But, for some people, the eye loses its power of accommodation. This could happen due to many reasons including ageing. Hence, their vision becomes defective. Let us discuss some of the common defects of human eye.

#### Myopia

Myopia, also known as short sightedness, occurs due to the lengthening of eye ball. With this defect, nearby objects can be seen clearly but distant objects cannot be seen clearly. The focal length of eye lens is reduced or the distance between eye lens and retina increases. Hence, the far point will not be infinity for such eyes and the far point has come closer. Due to this, the image of distant objects are formed before the retina (Figure 2.16-a). This defect can be corrected using a concave lens (Figure 2.16-b). The focal length of the concave lens to be used is computed as follows:

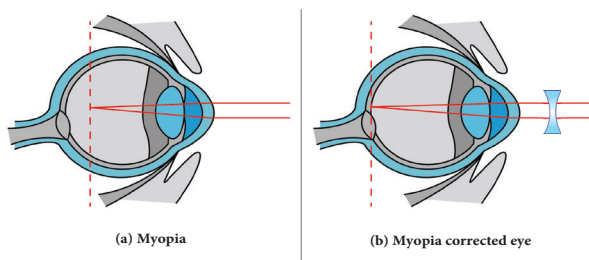

**Figure 2.16** (a) Vision with myopia  
b) Corrected vision using a concave lens

Let a person with myopia eye can see up to a distance  $x$ . Suppose that he wants to see all objects farther than this distance, i.e., up to infinity. Then the focal length of the required concave lens is  $f = -x$ . If the person can see up to a distance  $x$  and if he wishes to see up

to a distance  $y$ , then, the focal length of the required concave lens is,

$$f = \frac{xy}{x-y} \dots\dots\dots(2.7)$$

#### Hypermetropia

Hypermetropia, also known as long sightedness, occurs due to the shortening of eye ball. With this defect, distant objects can be seen clearly but nearby objects cannot be seen clearly. The focal length of eye lens is increased or the distance between eye lens and retina decreases. Hence, the near point will not be at 25cm for such eyes and the near point has moved farther. Due to this, the image of nearby objects are formed behind the retina (Figure 2.17-a). This defect can be corrected using a convex lens (Figure 2.17-b). The focal length of the convex lens to be used is computed as follows:

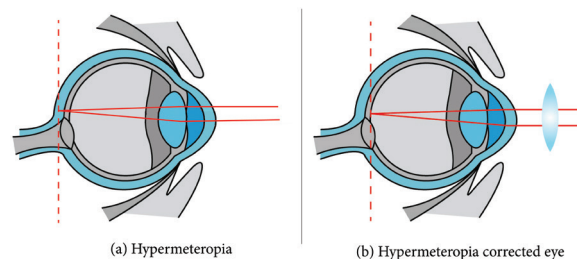

**Figure 2.17** (a) Vision with hypermetropia  
b) Corrected vision using a convex lens

Let a person with hypermetropia eye can see object beyond a distance  $d$ . Suppose that he wants to see all objects closer than this distance up to a distance  $D$ . Then, the focal length of the required convex lens is

$$f = \frac{dD}{d-D} \dots\dots\dots(2.8)$$

#### Presbyopia

Due to ageing, ciliary muscles become weak and the eye-lens become rigid (inflexible) andso the eye loses its power of accommodation.

Because of this, an aged person cannot see the nearby objects clearly. So, it is also called as 'old age hypermetropia'.

Some persons may have both the defects of vision - myopia as well as hypermetropia. This can be corrected by 'bifocal lenses'. In which, upper part consists of concave lens (to correct myopia) used for distant vision and the lower part consists of convex lens (to correct hypermetropia) used for reading purposes.

### Astigmatism

In this defect, eye cannot see parallel and horizontal lines clearly. It may be inherited or acquired. It is due to the imperfect structure of eye lens because of the development of cataract on the lens, ulceration of cornea, injury to the refracting surfaces, etc. Astigmatism can be corrected by using cylindrical lenses.

## 2.18 MICROSCOPE

This is an optical instrument, which helps us to see tiny (very small) objects. It is classified as

1. Simple microscope
2. Compound microscope

### Simple Microscope

Simple microscope has a convex lens of short focal length. It is held near the eye to get enlarged image of small objects.

Let an object (AB) is placed at a point within the principal focus ( $u < f$ ) of the convex lens and the observer's eye is placed just behind

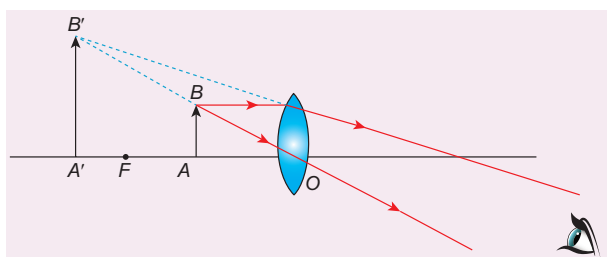

Figure 2.18 Image formation in simple microscope

the lens. As per this position the convex lens produces an erect, virtual and enlarged image (A'B'). The image formed is in the same side of the object and the distance equal to the least distance of distinct vision (D) (For normal human eye  $D = 25$  cm).

### Uses of Simple microscope

Simple microscopes are used

- a) by watch repairers and jewellers.
- b) to read small letters clearly.
- c) to observe parts of flower, insects etc.
- d) to observe finger prints in the field of forensic science.

### Compound microscope

Compound microscope is also used to see the tiny objects. It has better magnification power than simple microscope.

Magnification power of microscopes can be increased by decreasing the focal length of the lens used. Due to constructional limitations, the focal length of the lens cannot be decreased beyond certain limit. This problem can be solved by using two separate biconvex lenses.

### Construction

A compound microscope consists of two convex lenses. The lens with the shorter focal length is placed near the object, and is called as 'objective lens' or 'objective piece'. The lens with larger focal length and larger aperture placed near the observer's eye is called as 'eye lens' or 'eye piece'. Both the lenses are fixed in a narrow tube with adjustable provision.

### Working

The object (AB) is placed at a distance slightly greater than the focal length of objective lens ( $u > f_o$ ). A real, inverted and magnified image (A'B') is formed at the other

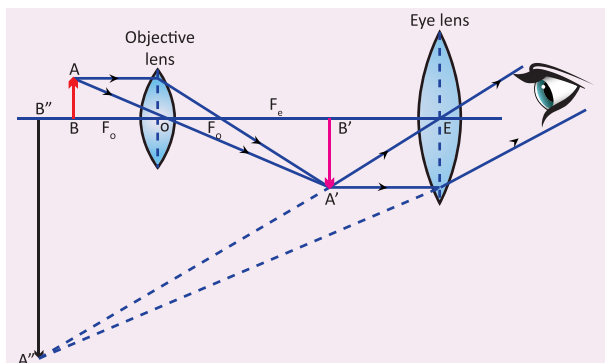

**Figure 2.19** Image formation in compound microscope

side of the objective lens. This image behaves as the object for the eye lens. The position of the eye lens is adjusted in such a way, that the image (A'B') falls within the principal focus of the eye piece. This eye piece forms a virtual, enlarged and erect image (A''B'') on the same side of the object

Compound microscope has 50 to 200 times more magnification power than simple microscope

### Travelling Microscope

A **travelling microscope** is one of the best instrument for measuring very small length with high degree of accuracy at the order of 0.01mm. It works based on the principle of vernier. Its least count is 0.01 mm.

## 2.19 TELESCOPE

Have you seen the recent lunar eclipse? With our naked eye we can't visualize the phenomena distinctly. Then, how can we see the distant object in clearer manner? It is possible with telescope.

Telescope is an optical instrument to see the distant objects. The first telescope was invented by Johann Lippershey in 1608. Galileo made a telescope to observe distant stars. He got the idea, from a spectacle maker who one day observed that the distant weather cock appeared magnified through his lens system fitted in his shop. Galileo observed the satellites of Jupiter and the rings of Saturn through his telescope. Kepler invented Telescope in

1611 which was fundamentally similar to the astronomical telescope.

### Types of Telescope

According to optical property, it is classified into two groups:

- i) refracting telescope ii) reflecting telescope

In **refracting telescope** lenses are used. Galilean telescope, Keplerian telescope, Achromatic refractors, are some refracting telescopes.

In **reflecting telescope** parabolic mirrors are used Gregorian, Newtonian, Cassegrain telescope are some **Reflecting telescopes**

According to the things which are observed, **Astronomical Telescope** and **Terrestrial Telescopes** are the two major types of telescope.

### Astronomical Telescope

An astronomical telescope is used to view heavenly bodies like stars, planets galaxies and satellites.

### Terrestrial Telescopes

The image in an astronomical telescope is inverted. So, it is not suitable for viewing objects on the surface of the Earth. Therefore, a terrestrial telescope is used. It provides an erect image. The major difference between astronomical and terrestrial telescope is erecting the final image with respect to the object.

### Advantages of Telescopes

- Elaborate view of the Galaxies, Planets, stars and other heavenly bodies is possible.
- Camera can be attached for taking photograph for the celestial objects.
- Telescope can be viewed even with the low intensity of light.

### Disadvantages

- Frequent maintenances needed.
- It is not easily portable one.

**Points to Remember**

- ❖ Light is a form of energy which travels along a straight line
- ❖ The deviation in the path of light ray is called refraction.
- ❖ The ratio of speed of light in vacuum to the speed of light in a medium is defined as refractive index 'μ' of that medium.
- ❖ Lens formula
 
$$\frac{1}{f} = \frac{1}{v} - \frac{1}{u}$$
- ❖ Magnification (m) =  $\frac{h'}{h} = \frac{v}{u}$
- ❖ Power of lens.  $P = \frac{1}{f}$
- ❖ The ability of the eye lens to focus nearby as well as the distant objects is called power of accommodation of the eye.
- ❖ A microscope is an optical instrument which helps us to see the objects which are very small in dimension.
- ❖ Telescope is an optical instrument used to see the distant objects clearly.

**SOLVED PROBLEMS**

**Problem 1**

Light rays travel from vacuum into a glass whose refractive index is 1.5. If the angle of incidence is 30°, calculate the angle of refraction inside the glass.

**Solution:**

according to Snell's law,

$$\frac{\sin i}{\sin r} = \frac{\mu_2}{\mu_1}$$

$$\mu_1 \sin i = \mu_2 \sin r$$

Here  $\mu_1 = 1.0$ ,  $\mu_2 = 1.5$ ,  $i = 30^\circ$

$$(1.0) \sin 30^\circ = 1.5 \sin r$$

$$1 \times \frac{1}{2} = 1.5 \sin r$$

$$\sin r = \frac{1}{2 \times 1.5} = \frac{1}{3} = (0.333)$$

$$r = \sin^{-1}(0.333)$$

$$r = 19.45^\circ$$

**Problem-2**

A beam of light passing through a diverging lens of focal length 0.3m appear to be focused at a distance 0.2m behind the lens. Find the position of the object.

**Solution:**

$$f = -0.3 \text{ m}, v = -0.2 \text{ m}$$

$$\frac{1}{f} = \frac{1}{v} - \frac{1}{u}$$

$$\frac{1}{u} = \frac{1}{v} - \frac{1}{f}$$

$$\frac{1}{u} = \frac{1}{-0.2} - \frac{1}{-0.3} = \frac{-10}{6}$$

$$u = \frac{-6}{10} = -0.6 \text{ m}$$

**Problem-3**

A person with myopia can see objects placed at a distance of 4m. If he wants to see objects at a distance of 20m, what should be the focal length and power of the concave lens he must wear?

**Solution:**

Given that  $x = 4\text{m}$  and  $y = 20\text{m}$ .

Focal length of the correction lens is

$$f = \frac{xy}{x-y} \quad (\text{Refer eqn.2.7})$$

$$f = \frac{4 \times 20}{4 - 20} = \frac{80}{-16} = -5 \text{ m}$$

Power of the correction lens

$$= \frac{1}{f} = -\frac{1}{5} = -0.2 \text{ D}$$

**Problem-4**

For a person with hypermeteropia, the near point has moved to 1.5m. Calculate the focal length of the correction lens in order to make his eyes normal.

**Solution:**

Given that,  $d = 1.5\text{m}$ ;  $D = 25\text{cm} = 0.25\text{m}$  (For a normal eye).

From equation (2.8), the focal length of the correction lens is

$$f = \frac{d \times D}{d - D} = \frac{1.5 \times 0.25}{1.5 - 0.25} = \frac{0.375}{1.25} = 0.3 \text{ m}$$



**IV. Match the following:**

Column - I	Column - II
1 Retina	a Path way of light
2 Pupil	b Far point comes closer
3 Ciliary muscles	c near point moves away
4 Myopia	d Screen of the eye
5 Hypermetropia	f Power of accommodation

**V. Assertion and reasoning type**

Mark the correct choice as

- If both assertion and reason are true and reason is the correct explanation of assertion.
- If both assertion and reason are true but reason is not the correct explanation of assertion.
- Assertion is true but reason is false.
- Assertion is false but reason is true.

- Assertion:** If the refractive index of the medium is high (denser medium) the velocity of the light in that medium will be small

**Reason:** Refractive index of the medium is inversely proportional to the velocity of the light

- Assertion:** Myopia is due to the increase in the converging power of eye lens.

**Reason:** Myopia can be corrected with the help of concave lens.

**VI. Answer Briefly**

- What is refractive index?
- State Snell's law.
- Draw a ray diagram to show the image formed by a convex lens when the object is placed between F and 2F.
- Define dispersion of light
- State Rayleigh's law of scattering
- Differentiate convex lens and concave lens.
- What is power of accommodation of eye?
- What are the causes of 'Myopia'?

- Why does the sky appear in blue colour?
- Why are traffic signals red in colour?

**VII. Give the answer in detail**

- List any five properties of light
- Explain the rules for obtaining images formed by a convex lens with the help of ray diagram.
- Differentiate the eye defects: Myopia and Hypermetropia
- Explain the construction and working of a 'Compound Microscope'.

**VIII. Numerical Problems:**

- An object is placed at a distance 20cm from a convex lens of focal length 10cm. Find the image distance and nature of the image.
- An object of height 3cm is placed at 10cm from a concave lens of focal length 15cm. Find the size of the image.

**IX. Higher order thinking (HOT) questions:**

- While doing an experiment for the determination of focal length of a convex lens, Raja Suddenly dropped the lens. It got broken into two halves along the axis. If he continues his experiment with the same lens, (a) can he get the image? (b) Is there any change in the focal length?
- The eyes of the nocturnal birds like owl are having a large cornea and a large pupil. How does it help them?



**REFERENCE BOOKS**

- Fundamentals of optics by D.R. Khanna and H.R. Gulati, R. Chand & Co.
- Principles of Physics – Halliday, Resnick & Walker, Wiley Publications, New Delhi.



**INTERNET RESOURCES**

- [www.physicsabout.com](http://www.physicsabout.com)
- [www.khanacademy.org](http://www.khanacademy.org)

## Concept Map

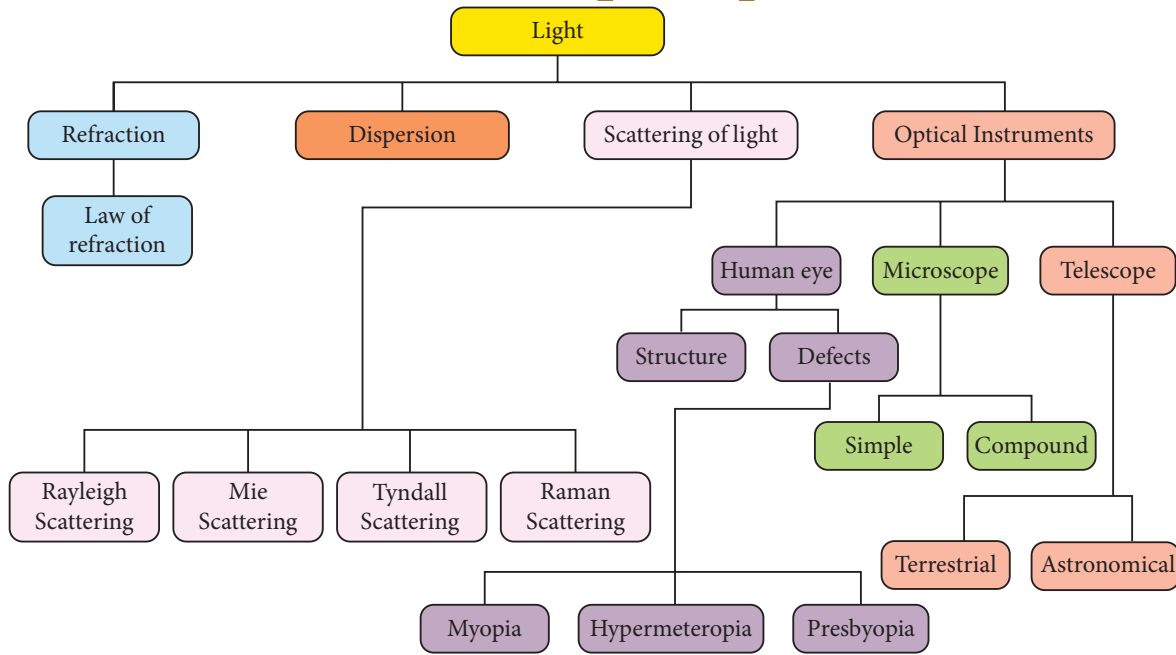

### ICT CORNER

## Formation of different types of images by a convex lens

In this activity you will be able to understand the images formed by convex lenses.

#### Steps

- Open the browser and type 'phet.colorado.edu/en/simulation/legacy/geometric-optics' in the address bar.
- Take the pencil and raise it so that the eraser is sitting on the principal axis. Click on the "principal rays" button.
- Place the object at different positions (infinity, beyond 2F, at 2F, between F and 2F, at F, between F and optic centre) from a convex lens and observe different types of images. Explain the result.
- Will the rays ever form an image? Click on "virtual image" to check your answer.



Step1



Step2

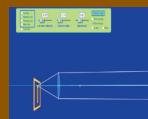

Step3

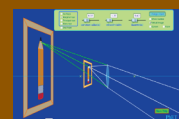

Step4

#### Cells alive

URL: <https://phet.colorado.edu/en/simulation/legacy/geometric-optics>

\*Pictures are indicative only



B375\_10\_SCIENCE\_EM



## Learning Objectives

At the end of this lesson, students will be able to

- ◆ Understand the concept of heat and temperature
- ◆ Know the absolute scale of temperature
- ◆ Understand the thermal energy and the thermal equilibrium
- ◆ Classification of expansion of substances
- ◆ Know the fundamental laws of gases
- ◆ Distinguish between real gas and ideal gas
- ◆ Derive the ideal gas equation
- ◆ Solve the numerical problems



6TEBIQ

## INTRODUCTION

Sun is the primary source of thermal energy for all living organisms. Thermal energy is the cause and temperature is the effect. All living organisms need a particular temperature for their survival. In the kitchen, a container with a steel bottom is placed on the induction stove. Do you know why? All of us have a common man's understanding of thermal energy and temperature. But, in this chapter, you shall learn about thermal energy and temperature in a scientific manner. We shall also discuss about how thermal energy is transferred and the effects of thermal energy.

### 3.1 TEMPERATURE

Temperature is defined as the degree of hotness of a body. The temperature is higher for a hotter body than for a colder body. It is also be defined as the property

which determines whether a body is in equilibrium or not with the surroundings. (or average kinetic energy of the molecules). Further, temperature is the property, which determines the direction of flow of heat. It is a scalar quantity. The SI unit of temperature is kelvin (K). There are other commonly used units of temperature such as degree celsius ( $^{\circ}\text{C}$ ) and degree fahrenheit ( $^{\circ}\text{F}$ ).

#### 3.1.1 Absolute scale (kelvin scale) of temperature

The temperature measured in relation to absolute zero using the kelvin scale is known as absolute scale temperature. It is also known as the **thermodynamic temperature**. Each unit of the thermodynamic scale of temperature is defined as the fraction of  $1/273.16^{\text{th}}$  part of the thermodynamic temperature of the triple point of water. A temperature difference of  $1^{\circ}\text{C}$  is equal to that of 1K. Zero Kelvin is the absolute scale of temperature of the body.



The relation between the different types of scale of temperature:

$$\text{Celsius and Kelvin: } K = C + 273,$$

$$\text{Fahrenheit and Kelvin: } [K] = (F + 460) \times \frac{5}{9}$$

$$0 \text{ K} = -273^\circ\text{C}.$$

### 3.1.2 Thermal equilibrium

Two or more physical systems or bodies are said to be in thermal equilibrium if there is no net flow of thermal energy between the systems.

Heat energy always flows from one body to the other due to a temperature difference between them. Thus, you can define thermal equilibrium in another way. If two bodies are said to be in thermal equilibrium, then, they will be at the same temperature. What will happen if two bodies at different temperatures are brought in contact with one other? There will be a transfer of heat energy from the hot body to the cold body until a thermal equilibrium is established between them. This is depicted in Figure 3.1.

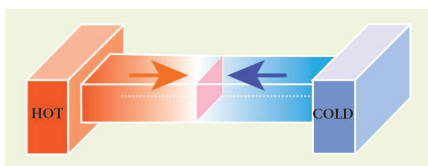

Figure 3.1 Establishing thermal equilibrium

When a cold body is placed in contact with a hot body, some thermal energy is transferred from the hot body to the cold body. As a result, there is some rise in the temperature of the cold body and decrease in the temperature of the hot body. This process will continue until these two bodies attain the same temperature.

## 3.2 THERMAL ENERGY

If you leave a cup of hot milk on a table for some time, what happens? The hotness of the milk decreases after some time. Similarly, if you keep a bottle of cold water on a table, the water becomes warmer after some time. What do you infer from these observations? In the case of hot milk, there is a flow of energy from the cup of

milk to the environment. In the second case, the energy is transferred from the environment to the water bottle. This energy is termed as “thermal energy”.

When a hot object is in contact with another cold object, a form of energy flows from the hot object to the cold object, which is known as **thermal energy**. Thus, thermal energy is a form of energy which is transferred between any two bodies due to the difference in their temperatures. Thermal energy is also known as 'heat energy' or simply 'heat'.

Heat energy is the agent, which produces the sensation of warmth and makes bodies hot. The process in which heat energy flows from a body at a higher temperature to another object at lower temperature is known as **heating**. This process of transmission of heat may be done in any of the ways like conduction, convection or radiation. Heat is a scalar quantity. The SI unit of heat energy absorbed or evolved is joule (J).

During the process of transferring heat energy, the body at lower temperature is heated while the body at higher temperature is cooled. Thus, sometimes, this process of transfer of heat energy is termed as 'cooling'. But, in most of the cases the term 'heating' is used instead of 'cooling'. When the thermal energy is transferred from one body to another, this results in the rise or lowering of the temperature of either of the bodies.

### 3.2.1 Characteristic features of heat energy transfer

1. Heat always flows from a system at higher temperature to a system at lower temperature.
2. The mass of a system is not altered when it is heated or cooled.
3. For any exchange of heat, the heat gained by the cold system is equal to heat lost by the hot system.

$$\text{Heat gained} = \text{Heat lost}$$

### 3.2.2 Other units of Heat energy

Though the SI unit of heat energy is joule, there are some other commonly used units.

**Calorie:** One calorie is defined as the amount of heat energy required to rise the temperature of 1 gram of water through 1°C.

**Kilocalorie:** One kilocalorie is defined as the amount of heat energy required to rise the temperature of 1 kilogram of water through 1°C.

### 3.3 EFFECT OF HEAT ENERGY

When a certain amount of heat energy is given to a substance, it will undergo one or more of the following changes:

- Temperature of the substance rises.
- The substance may change its state from solid to liquid or from liquid to gas.
- The substance will expand when heated.

The rise in temperature is in proportion to the amount of heat energy supplied. It also depends on the nature and mass of the substance. About the rise in temperature and the change of state, you have studied in previous classes. In the following section, we shall discuss about the expansion of substances due to heat.

#### 3.3.1 Expansion of Substances

When heat energy is supplied to a body, there can be an increase in the dimension of the object. This change in the dimension due to rise in temperature is called thermal expansion of the object. The expansion of liquids (e.g. mercury) can be seen when a thermometer is placed in warm water. All forms of matter (solid, liquid and gas) undergo expansion on heating.



#### a) Expansion in solids

When a solid is heated, the atoms gain energy and vibrate more vigorously. This results in the expansion of the solid. For a given change in temperature, the extent of expansion is smaller in solids than in liquids and gases. This is due to the rigid nature of solids.

The different types of expansion of solid are listed and explained below:

1. Linear expansion
2. Superficial expansion
3. Cubical expansion

##### 1. Linear expansion:

When a body is heated or cooled, the length of the body changes due to change in its temperature. Then the expansion is said to be **linear or longitudinal expansion**.

The ratio of increase in length of the body per degree rise in temperature to its unit length is called as the **coefficient of linear expansion**. The SI unit of Coefficient of Linear expansion is  $K^{-1}$ . The value of coefficient of linear expansion is different for different materials.

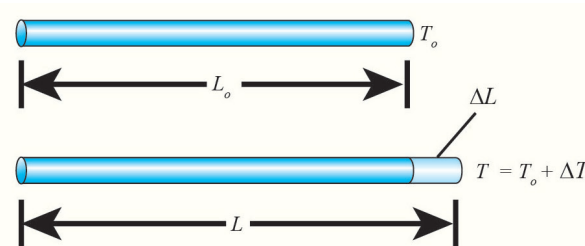

Figure 3.2 Linear expansion

The equation relating the change in length and the change in temperature of a body is given below:

$$\frac{\Delta L}{L_0} = \alpha_l \Delta T$$

$\Delta L$  - Change in length (Final length - Original length)

$L_0$  - Original length

$\Delta T$  - Change in temperature (Final temperature - Initial temperature)

$\alpha_l$  - Coefficient of linear expansion.

**2. Superficial expansion:**

If there is an increase in the area of a solid object due to heating, then the expansion is called **superficial or areal expansion**.

Superficial expansion is determined in terms of coefficient of superficial expansion. The ratio of increase in area of the body per degree rise in temperature to its unit area is called as **coefficient of superficial expansion**. Coefficient of superficial expansion is different for different materials. The SI unit of Coefficient of superficial expansion is  $K^{-1}$

The equation relating to the change in area and the change in temperature is given below:

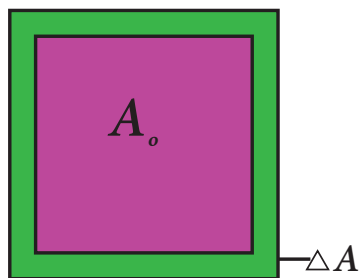

**Figure 3.3** Superficial expansion

$$\frac{\Delta A}{A_o} = \alpha_A \Delta T$$

$\Delta A$  - Change in area (Final area - Initial area)

$A_o$  - Original area

$\Delta T$  - Change in temperature (Final temperature - Initial temperature)

$\alpha_A$  - Coefficient of superficial expansion.

**3. Cubical expansion:**

If there is an increase in the volume of a solid body due to heating, then the expansion is called **cubical or volumetric expansion**.

As in the cases of linear and areal expansion, cubical expansion is also expressed in terms of coefficient of cubical expansion. The ratio of increase in volume of the body per degree rise in temperature to its unit volume is called as **coefficient of cubical expansion**. This is also measured in  $K^{-1}$ .

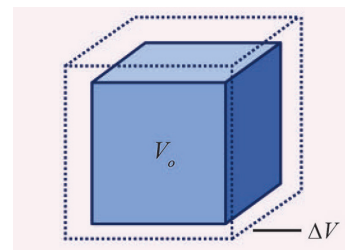

**Figure 3.4** Cubical expansion

The equation relating to the change in volume and the change in temperature is given below:

$$\frac{\Delta V}{V_o} = \alpha_v \Delta T$$

$\Delta V$  - Change in volume (Final volume - Initial volume)

$V_o$  - Original volume

$\Delta T$  - Change in temperature (Final temperature - Initial temperature)

$\alpha_v$  - Coefficient of cubical expansion.

Different materials possess different coefficient of cubical expansion. Table 3.1 gives the coefficient of cubical expansion for some common materials.

**Table 3.1** Coefficient of cubical expansion of some materials

S.No.	Name of the material	Coefficient of cubic expansion ( $K^{-1}$ )
1	Aluminium	$7 \times 10^{-5}$
2	Brass	$6 \times 10^{-5}$
3	Glass	$2.5 \times 10^{-5}$
4	Water	$20.7 \times 10^{-5}$
5	Mercury	$18.2 \times 10^{-5}$

**b) Expansion in liquids and gases**

When heated, the atoms in a liquid or gas gain energy and are forced further apart. The extent of expansion varies from substance to substance. For a given rise in temperature, a liquid will have more expansion than a solid and a gaseous substance has the highest expansion when compared with the other two. The coefficient of cubical expansion of liquid is independent of temperature whereas its value for gases depends on the temperature of gases.

When a liquid is heated, it is done by keeping the liquid in some container and supplying heat energy to the liquid through the container. The thermal energy supplied will be partly used in expanding the container and partly used in expanding the liquid. Thus, what we observe may not be the actual or real expansion of the liquid. Hence, for liquids, we can define real expansion and apparent expansion.

### 1) Real expansion

If a liquid is heated directly without using any container, then the expansion that you observe is termed as **real expansion** of the liquid.

**Coefficient of real expansion** is defined as the ratio of the true rise in the volume of the liquid per degree rise in temperature to its unit volume. The SI unit of coefficient of real expansion is  $K^{-1}$ .

### 2) Apparent expansion

Heating a liquid without using a container is not possible. Thus, in practice, you can heat any liquid by pouring it in a container. A part of thermal energy is used in expanding the container and a part is used in expanding the liquid. Thus, what you observe is not the actual or real expansion of the liquid. The expansion of a liquid apparently observed without considering the expansion of the container is called the **apparent expansion** of the liquid.

**Coefficient of apparent expansion** is defined as the ratio of the apparent rise in the volume of the liquid per degree rise in temperature to its unit volume. The SI unit of coefficient of apparent expansion is  $K^{-1}$ .

### 3.3.2 Experiment to measure real and apparent expansion of liquid

To start with, the liquid whose real and apparent expansion is to be determined is poured in a container up to a level. Mark this level as  $L_1$ . Now, heat the container and the liquid using a burner as shown in the Figure 3.5. Initially, the container receives the thermal

energy and it expands. As a result, the volume of the liquid appears to have reduced. Mark this reduced level of liquid as  $L_2$ .

On further heating, the thermal energy supplied to the liquid through the container results in the expansion of the liquid. Hence, the level of liquid rises to  $L_3$ . Now, the difference between the levels  $L_1$  and  $L_3$  is called as **apparent expansion**, and the difference between the levels  $L_2$  and  $L_3$  is called **real expansion**. The real expansion is always more than that of apparent expansion.

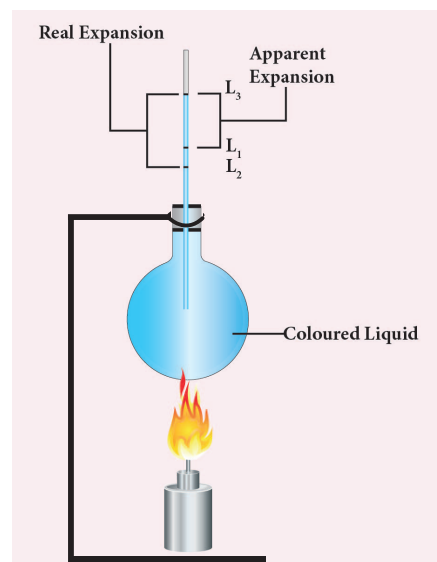

Figure 3.5 Real and apparent expansion of liquid

$$\text{Real expansion} = L_3 - L_2$$

$$\text{Apparent expansion} = L_3 - L_1$$

## 3.4 FUNDAMENTAL LAWS OF GASES

The three fundamental laws which connect the relation between pressure, volume and temperature are as follows:

- 1) Boyle's Law
- 2) Charles's law
- 3) Avogadro's law

### 3.4.1 Boyle's law:

When the temperature of a gas is kept constant, the volume of a fixed mass of gas is inversely proportional to its pressure. This is shown in Figure 3.6.

$$P \propto 1/V$$



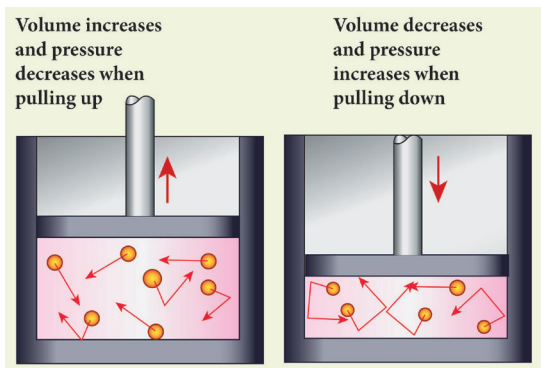

Figure 3.6 Variation of volume with pressure

In other words, for an invariable mass of a perfect gas, at constant temperature, the product of its pressure and volume is a constant.

$$(i.e) PV = \text{constant}$$

### 3.4.2 Charles's law (The law of volume)

Charles's law was formulated by a French scientist Jacques Charles. According to this law, *When the pressure of gas is kept constant, the volume of a gas is directly proportional to the temperature of the gas.*

$$V \propto T$$

$$\text{or } \frac{V}{T} = \text{constant}$$

### 3.4.3 Avogadro's law

Avogadro's law states that at constant pressure and temperature, the volume of a gas is directly proportional to number of atoms or molecules present in it.

$$i.e. V \propto n$$

$$(or) \frac{V}{n} = \text{constant}$$

Avogadro's number ( $N_A$ ) is the total number of atoms per mole of the substance. It is equal to  $6.023 \times 10^{23}$  /mol.



## 3.5 GASES

Gases are classified as real gases and ideal gases.

### 3.5.1 Real Gases

If the molecules or atoms of a gases interact with each other with a definite amount of intermolecular or inter atomic force of attraction, then the gases are said to be **real gases**. At very high temperature or low pressure, a real gases behaves as an ideal gases because in this condition there is no interatomic or intermolecular force of attraction.

### 3.5.2 Ideal Gases

If the atoms or molecules of a gas do not interact with each other, then the gas is said to be an **ideal gas** or a **perfect gas**.

Actually, in practice, no gas is ideal. The molecules of any gas will have a certain amount of interaction among them. But, these interactions are weaker when the pressure is low or the temperature is high because the interatomic or intermolecular forces of attraction are weak in ideal gas. Hence, a real gas at low pressure or high temperature can be termed as a perfect gas.

Ideal gases obey Boyle's law, Charles's law and Avogadro's law. All these laws state the relationship between various properties of a gas such as pressure (P), volume (V), temperature (T) and number of atoms (n). In a given state of the gas, all these parameters will have a definite set of values. When there is a change in the state of the gas, any one or more of these parameters change its value. The above said laws relate these changes.

### 3.5.3 Ideal Gas Equation

The ideal gas equation is an equation, which relates all the properties of an ideal gas. An ideal gas obeys Boyle's law and Charles' law and Avogadro's law. According to Boyle's law,

$$PV = \text{constant} \quad (3.1)$$

According to Charles's law,

$$V/T = \text{constant} \quad (3.2)$$

According to Avogadro's law,

$$V/n = \text{constant} \quad (3.3)$$

After combining equations (3.1), (3.2) and (3.3), you can get the following equation.

$$PV/nT = \text{constant} \quad (3.4)$$

The above relation is called the combined law of gases. If you consider a gas, which contains  $\mu$  moles of the gas, the number of atoms contained will be equal to  $\mu$  times the Avogadro number,  $N_A$ .

$$\text{i.e. } n = \mu N_A \quad (3.5)$$

Using equation (3.5), equation (3.4) can be written as

$$PV/\mu N_A T = \text{constant}$$

The value of the constant in the above equation is taken to be  $k_B$ , which is called as **Boltzmann constant** ( $1.38 \times 10^{-23} \text{ JK}^{-1}$ ). Hence, we have the following equation:

$$\begin{aligned} PV/\mu N_A T &= k_B \\ PV &= \mu N_A k_B T \end{aligned}$$

Here,  $\mu N_A k_B = R$ , which is termed as universal gas constant whose value is

$$8.31 \text{ J mol}^{-1} \text{ K}^{-1}.$$

$$PV = RT \quad (3.6)$$

Ideal gas equation is also called as *equation of state* because it gives the relation between the state variables and it is used to describe the state of any gas.

### Points to Remember

- ❖ The SI unit of heat energy absorbed or evolved is joule (J)
- ❖ Heat always flows from a system at higher temperature to a system at lower temperature.
- ❖ **Temperature** is defined as the degree of hotness of a body. The SI unit of temperature is kelvin (K).

❖ All the substances will undergo one or more of the following changes when heated:

- i) Temperature of the substance rises.
- ii) The substance may change state from solid to liquid or gas.
- iii) The substance will expand when heated.

❖ All forms of matter (solid, liquid and gas) undergo expansion on heating.

❖ For a given rise in temperature, a liquid will have more expansion than a solid and a gaseous substance has the highest expansion than the other two.

❖ If a liquid is heated directly without using any container, then the expansion that you observe is termed as **real expansion** of the liquid.

❖ The expansion of a liquid apparently observed without considering the expansion of the container is called the **apparent expansion** of liquid.

❖ For a given heat energy, the real expansion is always more than that of apparent expansion.

❖ If the atoms or molecules of a gas do not interact with each other, then the gas is said to be an **ideal gas** or a **perfect gas**.

❖ Ideal gas equation, also called as equation of state is  $PV = RT$ . Here, R is known as universal gas constant whose value is  $8.31 \text{ J mol}^{-1} \text{ K}^{-1}$

### Solved Problems

#### Example 1

A container whose capacity is 70 ml is filled with a liquid up to 50 ml. Then, the liquid in the container is heated. Initially, the level of the liquid falls from 50 ml to 48.5 ml. Then we heat more, the level of the liquid rises to 51.2 ml. Find the apparent and real expansion.

**Data:**

Level of the liquid  $L_1 = 50 \text{ ml}$

Level of the liquid  $L_2 = 48.5 \text{ ml}$

Level of the liquid  $L_3 = 51.2 \text{ ml}$

$$\begin{aligned} \text{Apparent expansion} &= L_3 - L_1 \\ &= 51.2 \text{ ml} - 50 \text{ ml} = 1.2 \text{ ml} \end{aligned}$$

$$\begin{aligned} \text{Real expansion} &= L_3 - L_2 \\ &= 51.2 \text{ ml} - 48.5 \text{ ml} = 2.7 \text{ ml} \end{aligned}$$

So, Real expansion > apparent expansion

**Example 2**

Keeping the temperature as constant, a gas is compressed four times of its initial pressure. The volume of gas in the container

changing from 20cc ( $V_1$  cc) to  $V_2$  cc. Find the final volume  $V_2$ .

**Data:**

Initial pressure ( $P_1$ ) = P

Final Pressure ( $P_2$ ) = 4P

Initial volume ( $V_1$ ) = 20cc = 20cm<sup>3</sup>

Final volume ( $V_2$ ) = ?

Using Boyle's Law, PV = constant

$$P_1 V_1 = P_2 V_2$$

$$V_2 = \frac{P_1}{P_2} \times V_1$$

$$= \frac{P}{4P} \times 20 \text{ cm}^3$$

$$V_2 = 5 \text{ cm}^3$$



**TEXTBOOK EVALUATION**



**I. Choose the correct answer**

- The value of universal gas constant  
 a)  $3.81 \text{ Jmol}^{-1} \text{ K}^{-1}$     b)  $8.03 \text{ Jmol}^{-1} \text{ K}^{-1}$   
 c)  $1.38 \text{ Jmol}^{-1} \text{ K}^{-1}$     d)  $8.31 \text{ Jmol}^{-1} \text{ K}^{-1}$
- If a substance is heated or cooled, the change in mass of that substance is  
 a) positive                      b) negative  
 c) zero                              d) none of the above
- If a substance is heated or cooled, the linear expansion occurs along the axis of  
 a) X or -X                      b) Y or -Y  
 c) both (a) and (b)    d) (a) or (b)
- Temperature is the average \_\_\_\_\_ of the molecules of a substance  
 a) difference in K.E and P.E  
 b) sum of P.E and K.E  
 c) difference in T.E and P.E  
 d) difference in K.E and T.E

- In the Given diagram, the possible direction of heat energy transformation is

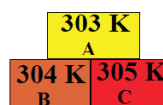

- $A \leftarrow B, A \leftarrow C, B \leftarrow C$
- $A \rightarrow B, A \rightarrow C, B \rightarrow C$
- $A \rightarrow B, A \leftarrow C, B \rightarrow C$
- $A \leftarrow B, A \rightarrow C, B \leftarrow C$

**II. Fill in the blanks:**

- The value of Avogadro number \_\_\_\_\_
- The temperature and heat are \_\_\_\_\_ quantities
- One calorie is the amount of heat energy required to raise the temperature of \_\_\_\_\_ of water through \_\_\_\_\_.
- According to Boyle's law, the shape of the graph between pressure and reciprocal of volume is \_\_\_\_\_

**III. State whether the following statements are true or false, if false explain why?**

- For a given heat in liquid, the apparent expansion is more than that of real expansion.

2. Thermal energy always flows from a system at higher temperature to a system at lower temperature.
3. According to Charles's law, at constant pressure, the temperature is inversely proportional to volume.

**IV. Match the items in column-I to the items in column-II**

Column-I	Column-II
1. Linear expansion	- (a) change in volume
2. Superficial expansion	- (b) hot body to cold body
3. Cubical expansion	- (c) $1.381 \times 10^{-23} \text{ JK}^{-1}$
4. Heat transformation	- (d) change in length
5. Boltzmann constant	- (e) change in area

**V. Assertion and reason type questions**

- a. Both the assertion and the reason are true and the reason is the correct explanation of the assertion.
- b. Both the assertion and the reason are true but the reason is not the correct explanation of the assertion.
- c. Assertion is true but the reason is false.
- d. Assertion is false but the reason is true.

1. **Assertion:** There is no effects on other end when one end of the rod is only heated.  
**Reason:** Heat always flows from a region of lower temperature to higher temperature of the rod.
2. **Assertion:** Gas is highly compressible than solid and liquid  
**Reason:** Interatomic or intermolecular distance in the gas is comparably high.

**VI. Answer in briefly**

1. Define one calorie.
2. Distinguish between linear, arial and superficial expansion.

3. What is co-efficient of cubical expansion?
4. State Boyle's law
5. State-the law of volume
6. Distinguish between ideal gas and real gas.
7. What is co-efficient of real expansion?
8. What is co-efficient of apparrant expansion?

**VII. Numerical problems**

1. Find the final temperature of a copper rod. Whose area of cross section changes from  $10 \text{ m}^2$  to  $11 \text{ m}^2$  due to heating. The copper rod is initially kept at  $90 \text{ K}$ . (Coefficient of superficial expansion is  $0.0021 / \text{K}$ )
2. Calculate the coefficient of cubical expansion of a zinc bar. Whose volume is increased  $0.25 \text{ m}^3$  from  $0.3 \text{ m}^3$  due to the change in its temperature of  $50 \text{ K}$ .

**VIII. Answer in detail**

1. Derive the ideal gas equation.
2. Explain the experiment of measuring the real and apparent expansion of a liquid with a neat diagram.

**IX. HOT question**

If you keep ice at  $0^\circ\text{C}$  and water at  $0^\circ\text{C}$  in either of your hands, in which hand you will feel more chillness? Why?

 **REFERENCE BOOKS**

- ◆ Thermodynamics and an introduction to thermo statistics by Herbert Hallen
- ◆ Fundamentals of Engineering Thermodynamics by Michael Moran.

 **INTERNET RESOURCE**

[http://aplusphysics.com/courses/honors/thermo/thermal\\_physics.html](http://aplusphysics.com/courses/honors/thermo/thermal_physics.html)



CONCEPT MAP

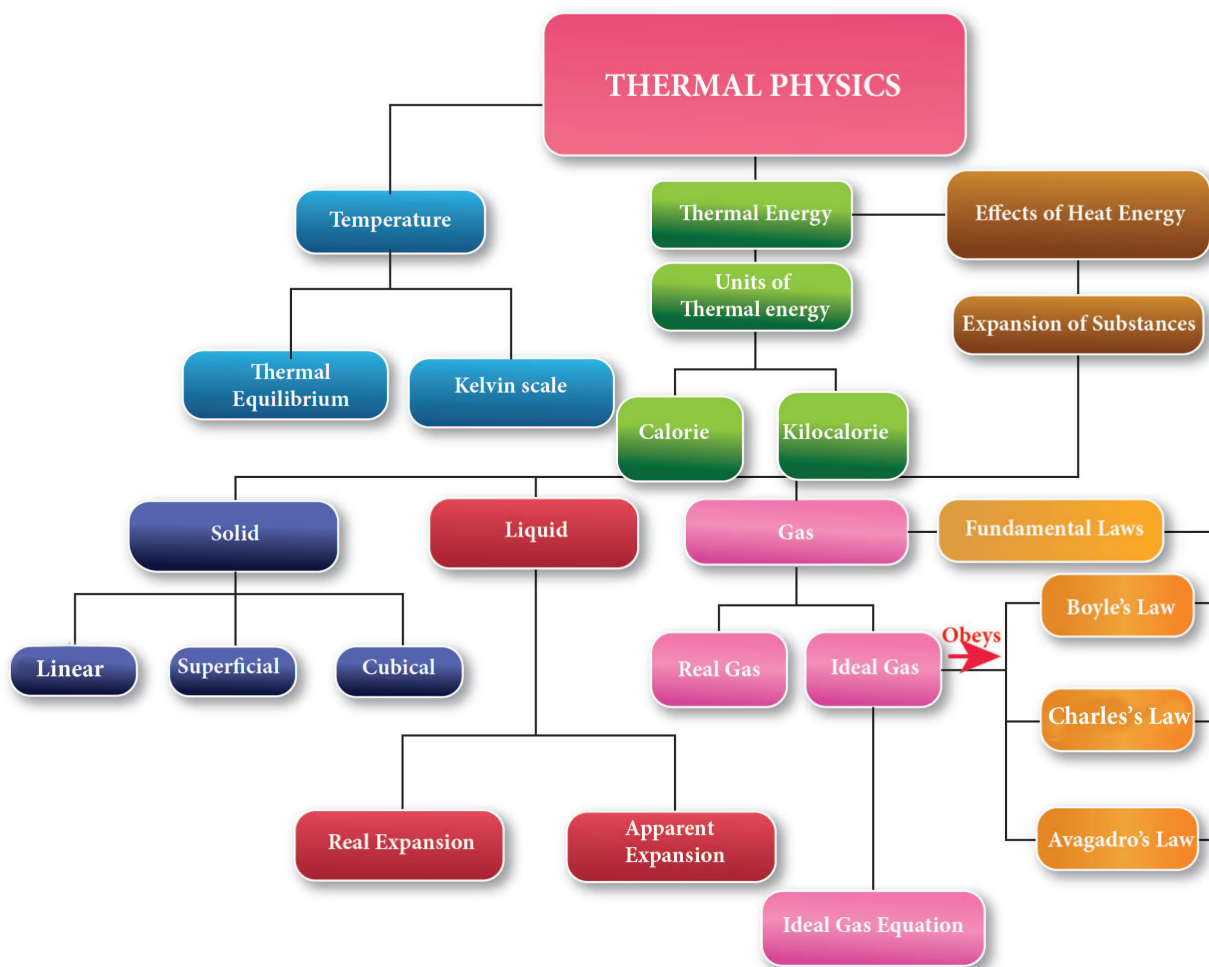

ICT CORNER

Boyle's law

In this activity you will be able to verify pressure is proportional to reciprocal of volume (Boyle's law).

Steps

- Open the browser and type "physics-chemistry-interactive-flash-animation.com/matter\_change\_state\_measurement\_mass\_volume/pressure\_volume\_boyle\_mariotte\_law\_ideal\_gas\_closed\_system\_MCQ.htm" in the address bar. Click enter to start the experiment.
- Change the volume by adjusting the piston of the syringe ( between 20 ml to 80 ml) and observe how the pressure changes.
- Tabulate observed values. You will observe when volume decreases pressure inside the syringe gets increased and vice versa. Thus boyle's law (  $PV = \text{constant}$ ) verified.

Cells alive

URL: [http://www.physics-chemistry-interactive-flash-animation.com/matter\\_change\\_state\\_measurement\\_mass\\_volume/pressure\\_volume\\_boyle\\_mariotte\\_law\\_ideal\\_gas\\_closed\\_system\\_MCQ.htm](http://www.physics-chemistry-interactive-flash-animation.com/matter_change_state_measurement_mass_volume/pressure_volume_boyle_mariotte_law_ideal_gas_closed_system_MCQ.htm)



B375\_10\_SCIENCE\_EM

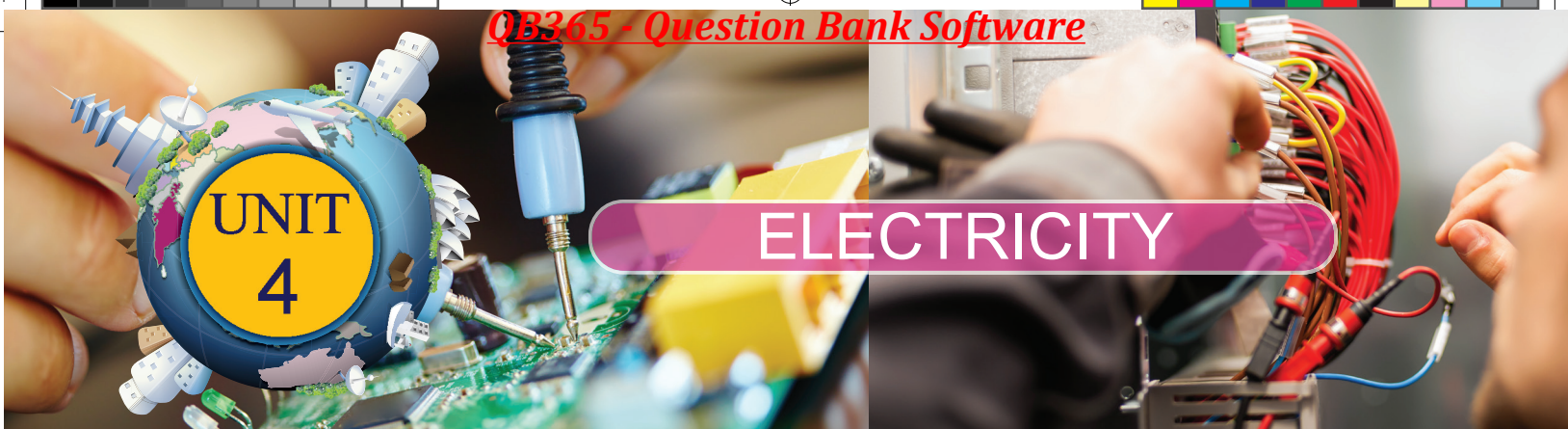

## Learning Objectives

At the end of this lesson, students will be able to:

- ◆ Make an electric circuit.
- ◆ Differentiate between electric potential and potential difference.
- ◆ Infer what electrical resistivity and conductivity mean.
- ◆ Know the effective resistance of a system of resistors connected in series and parallel.
- ◆ Understand the heating effect of the electric current.
- ◆ Define electric power and electric energy and explain domestic electric circuits.
- ◆ Know the modern appliances such as LED bulb and LED television.



9DAJQ1

## INTRODUCTION

You have already learnt about electricity in your lower classes, haven't you? Well, electricity deals with the flow of electric charges through a conductor. As a common term it refers to a form of energy. The usage of electric current in our day to day life is very important and indispensable. You are already aware of the fact that it is used in houses, educational institutions, hospitals, industries, etc. Therefore, its generation and transmission becomes a very crucial aspect of our life. In this lesson you will learn various terms used in understanding the concept of electricity. Eventually, you will realise the importance of the applications of electricity in day to day situations.

### 4.1 ELECTRIC CURRENT

The motion of electric charges (electrons) through a conductor (e.g., copper wire) will constitute an electric current. This is similar to

the flow of water through a channel or flow of air from a region of high pressure to a region of low pressure.

In a similar manner, the electric current passes from the positive terminal (higher electric potential) of a battery to the negative terminal (lower electric potential) through a wire as shown in the Figure 4.1.

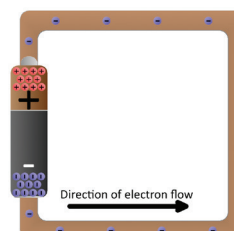

**Figure 4.1**  
Electron flow

#### 4.1.1 Definition of electric current

Electric current is often termed as 'current' and it is represented by the symbol 'I'. It is defined as **the rate of flow of charges in a conductor**. This means that the electric current represents the amount of charges flowing in any cross section of a conductor (say a metal wire) in unit time. If a net charge 'Q' passes through any cross section of a conductor in

time 't', then the current flowing through the conductor is

$$I = \frac{Q}{t} \quad (4.1)$$

### 4.1.2 SI unit of electric current

The SI unit of electric current is ampere (A). The current flowing through a conductor is said to be one ampere, when a charge of one coulomb flows across any cross-section of a conductor, in one second. Hence,

$$1 \text{ ampere} = \frac{1 \text{ coulomb}}{1 \text{ second}}$$

#### Solved Problem-1

A charge of 12 coulomb flows through a bulb in 5 second. What is the current through the bulb?

#### Solution:

Charge  $Q = 12 \text{ C}$ , Time  $t = 5 \text{ s}$ . Therefore, current  $I = \frac{Q}{t} = \frac{12}{5} = 2.4 \text{ A}$

## 4.2 ELECTRIC CIRCUIT

An electric circuit is a closed conducting loop (or) path, which has a network of electrical components through which electrons are able to flow. This path is made using electrical wires so as to connect an electric appliance to a source of electric charges (battery). A schematic diagram of an electric circuit comprising of a battery, an electric bulb, and a switch is given in Figure 4.2.

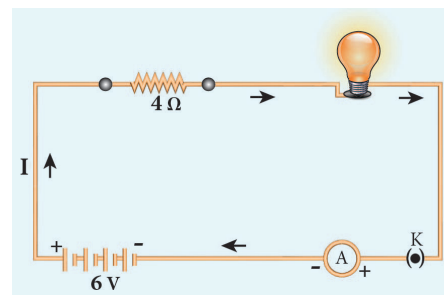

Figure 4.2 A simple electric circuit

Table 4.1 Symbols of some components of a circuit

COMPONENT	USE OF THE COMPONENT	SYMBOL USED
Resistor	Used to fix the magnitude of the current through a circuit	
Variable resistor or Rheostat	Used to select the magnitude of the current through a circuit.	
Ammeter	Used to measure the current.	
Voltmeter	Used to measure the potential difference.	
Galvanometer	Used to detect the current and its direction.	
A diode	It is used in electronic devices.	
Light Emitting Diode (LED)	It is used in seven segment display.	
Ground connection	Used to provide protection to the electrical components. It also serves as a reference point to measure the electric potential.	

In this circuit, if the switch is 'on', the bulb glows. If it is switched off, the bulb does not glow. Therefore, the circuit must be closed in order that the current passes through it. The potential difference required for the flow of charges is provided by the battery. The electrons flow from the negative terminal to the positive terminal of the battery.

*By convention, the direction of current is taken as the direction of flow of positive charge (or) opposite to the direction of flow of electrons.* Thus, electric current passes in the circuit from the positive terminal to the negative terminal.

### 4.2.1 Electrical components

The electric circuit given in Figure 4.2 consists of different components, such as a battery, a switch and a bulb. All these components can be represented by using certain symbols. It is easier to represent the components of a circuit using their respective symbols.

The symbols that are used to represent some commonly used components are given in Table 4.1. The uses of these components are also summarized in the table.

## 4.3 ELECTRIC POTENTIAL AND POTENTIAL DIFFERENCE

You are now familiar with the water current and air current. You also know that there must be a difference in temperature between two points in a solid for the heat to flow in it. Similarly, a difference in electric potential is needed for the flow of electric charges in a conductor. In the conductor, the charges will flow from a point in it, which is at a higher electric potential to a point, which is at a lower electric potential.

### 4.3.1 Electric Potential

The electric potential at a point is defined as the amount of work done in moving a unit positive charge from infinity to that point against the electric force.

### 4.3.2 Electric Potential Difference

The electric potential difference between two points is defined as the amount of work done in moving a unit positive charge from one point to another point against the electric force.



Figure 4.3 Electric potential

Suppose, you have moved a charge  $Q$  from a point  $A$  to another point  $B$ . Let ' $W$ ' be the work done to move the charge from  $A$  to  $B$ . Then, the potential difference between the points  $A$  and  $B$  is given by the following expression:

$$\text{Potential Difference (V)} = \frac{\text{Work Done (W)}}{\text{Charge (Q)}} \quad (4.2)$$

Potential difference is also equal to the difference in the electric potential of these two points. If  $V_A$  and  $V_B$  represent the electric potential at the points  $A$  and  $B$  respectively, then, the potential difference between the points  $A$  and  $B$  is given by:

$$V = V_A - V_B \text{ (if } V_A \text{ is more than } V_B \text{)}$$

$$V = V_B - V_A \text{ (if } V_B \text{ is more than } V_A \text{)}$$

### 4.3.3 Volt

The SI unit of electric potential or potential difference is volt (V).

The potential difference between two points is one volt, if one joule of work is done in moving one coulomb of charge from one point to another against the electric force.

$$1 \text{ volt} = \frac{1 \text{ joule}}{1 \text{ coulomb}}$$

### Solved Problem-2

The work done in moving a charge of 10 C across two points in a circuit is 100 J. What is the potential difference between the points?

**Solution:**

Charge,  $Q = 10 \text{ C}$  Work Done,  $W = 100 \text{ J}$

$$\text{Potential Difference } V = \frac{W}{Q} = \frac{100}{10}$$

Therefore,  $V = 10 \text{ volt}$

**4.4 OHM'S LAW**

A German physicist, Georg Simon Ohm established the relation between the potential difference and current, which is known as Ohm's Law. This relationship can be understood from the following activity.

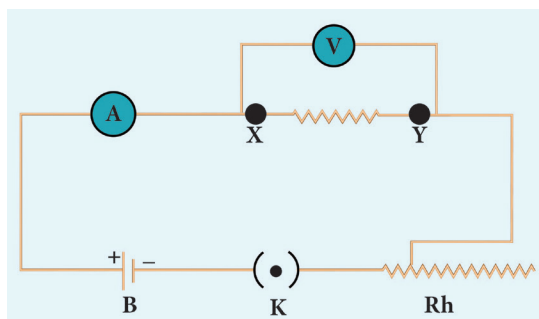

**Figure 4.4** Electric circuit to understand Ohm's law

According to Ohm's law, at a constant temperature, the steady current 'I' flowing through a conductor is directly proportional to the potential difference 'V' between the two ends of the conductor.

$$I \propto V. \text{ Hence, } \frac{I}{V} = \text{constant.}$$

The value of this proportionality constant is found to be  $\frac{1}{R}$

$$\text{Therefore, } I = \left(\frac{1}{R}\right) V$$

$$V = I R \tag{4.3}$$

Here, R is a constant for a given material (say Nichrome) at a given temperature and is known as the **resistance** of the material. Since, the potential difference V is proportional to the current I, the graph between V and I is a straight line for a conductor, as shown in the Figure 4.5.

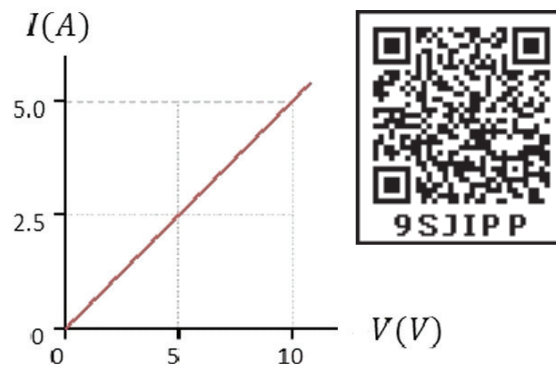

**Figure 4.5** Relation between potential difference and current

**4.5 RESISTANCE OF A MATERIAL**

In Figure 4.4, a Nichrome wire was connected between X and Y. If you replace the Nichrome wire with a copper wire and conduct the same experiment, you will notice a different current for the same value of the potential difference across the wire. If you again replace the copper wire with an aluminium wire, you will get another value for the current passing through it. From equation (4.3), you have learnt that  $V/I$  must be equal to the resistance of the conductor used. The variations in the current for the same values of potential difference indicate that the resistance of different materials is different. Now, the primary question is, "what is resistance?"

Resistance of a material is its property to oppose the flow of charges and hence the passage of current through it. **It is different for different materials.**

$$\text{From Ohm's Law, } \frac{V}{I} = R.$$

**The resistance of a conductor can be defined as the ratio between the potential difference across the ends of the conductor and the current flowing through it.**

**4.5.1 Unit of Resistance**

The SI unit of resistance is ohm and it is represented by the symbol  $\Omega$ .

**Resistance of a conductor is said to be one ohm if a current of one ampere flows through it when a potential difference of one volt is maintained across its ends.**

$$1 \text{ ohm} = \frac{1 \text{ volt}}{1 \text{ ampere}}$$

### Solved Problem-3

Calculate the resistance of a conductor through which a current of 2 A passes, when the potential difference between its ends is 30 V.

#### Solution:

Current through the conductor  $I = 2 \text{ A}$ ,  
Potential Difference  $V = 30 \text{ V}$

From Ohm's Law:  $R = \frac{V}{I}$ .

$$\text{Therefore, } R = \frac{30}{2} = 15 \Omega$$

## 4.6 ELECTRICAL RESISTIVITY & ELECTRICAL CONDUCTIVITY

### 4.6.1 Electrical Resistivity

You can verify by doing an experiment that the resistance of any conductor 'R' is directly proportional to the length of the conductor 'L' and is inversely proportional to its area of cross section 'A'.

$$R \propto L, R \propto \frac{1}{A},$$

$$\text{Hence, } R \propto \frac{L}{A}$$

$$\text{Therefore, } R = \rho \frac{L}{A} \quad (4.4)$$

Where,  $\rho$  (rho) is a constant, called as electrical resistivity or specific resistance of the material of the conductor.

$$\text{From equation (4.4), } \rho = \frac{RA}{L}$$

If  $L = 1 \text{ m}$ ,  $A = 1 \text{ m}^2$  then, from the above equation  $\rho = R$

Hence, the electrical resistivity of a material is **defined as the resistance of a conductor of unit length and unit area of cross section**. Its unit is **ohm metre**.

Electrical resistivity of a conductor is a measure of the resisting power of a specified material to the passage of an electric current. It is a constant for a given material.



Nichrome is a conductor with highest resistivity equal to  $1.5 \times 10^{-6} \Omega \text{ m}$ . Hence, it is used in making heating elements.

### 4.6.2 Conductance and Conductivity

Conductance of a material is the property of a material to aid the flow of charges and hence, the passage of current in it. The conductance of a material is mathematically **defined as the reciprocal of its resistance (R)**. Hence, the conductance 'G' of a conductor is given by

$$G = \frac{1}{R} \quad (4.5)$$

Its unit is  $\text{ohm}^{-1}$ . It is also represented as 'mho'.

**The reciprocal of electrical resistivity of a material is called its electrical conductivity.**

$$\sigma = \frac{1}{\rho} \quad (4.6)$$

Its unit is  $\text{ohm}^{-1} \text{ metre}^{-1}$ . It is also represented as  $\text{mho metre}^{-1}$ . The conductivity is a constant for a given material. Electrical conductivity of a conductor is a measure of its ability to pass the current through it. Some materials are good conductors of electric current. Example: copper, aluminium, etc. While some other materials are non-conductors of electric current (insulators). Example: glass, wood, rubber, etc.

Conductivity is more for conductors than for insulators. But, the resistivity is less for

conductors than for insulators. The resistivity of some commonly used materials is given in Table 4.2.

**Table 4.2** Resistivity of some materials

NATURE OF THE MATERIAL	MATERIAL	RESISTIVITY ( $\Omega \text{ m}$ )
Conductor	Copper	$1.62 \times 10^{-8}$
	Nickel	$6.84 \times 10^{-8}$
	Chromium	$12.9 \times 10^{-8}$
Insulator	Glass	$10^{10}$ to $10^{14}$
	Rubber	$10^{13}$ to $10^{16}$

**Solved Problem-4**

The resistance of a wire of length 10 m is 2 ohm. If the area of cross section of the wire is  $2 \times 10^{-7} \text{ m}^2$ , determine its (i) resistivity (ii) conductance and (iii) conductivity

**Solution:**

Given: Length,  $L = 10 \text{ m}$ , Resistance,  $R = 2 \text{ ohm}$  and Area,  $A = 2 \times 10^{-7} \text{ m}^2$

$$\text{Resistivity, } \rho = \frac{RA}{L} = \frac{2 \times 2 \times 10^{-7}}{10}$$

$$= 4 \times 10^{-8} \Omega \text{ m}$$

$$\text{Conductance, } G = \frac{1}{R} = \frac{1}{2} = 0.5 \text{ mho}$$

$$\text{Conductivity, } \sigma = \frac{1}{\rho} = \frac{1}{4 \times 10^{-8}}$$

$$= 0.25 \times 10^8 \text{ mho m}^{-1}$$

**4.7 SYSTEM OF RESISTORS**

So far, you have learnt how the resistance of a conductor affects the current through a circuit. You have also studied the case of the simple electric circuit containing a single resistor. Now in practice, you may encounter a complicated circuit, which uses a combination of many resistors. This combination of resistors

is known as ‘system of resistors’ or ‘grouping of resistors’. Resistors can be connected in various combinations. The two basic methods of joining resistors together are:

- a) Resistors connected in series, and b) Resistors connected in parallel.

In the following sections, you shall compute the effective resistance when many resistors having different resistance values are connected in series and in parallel.

**4.7.1 Resistors in series**

A series circuit connects the components one after the other to form a ‘single loop’. A series circuit has only one loop through which current can pass. If the circuit is interrupted at any point in the loop, no current can pass through the circuit and hence no electric appliances connected in the circuit will work. Series circuits are commonly used in devices such as flashlights. *Thus, if resistors are connected end to end, so that the same current passes through each of them, then they are said to be connected in series.*

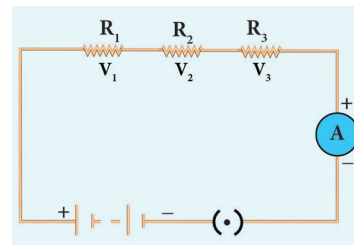

**Figure 4.6** Series connection of resistors

Let, three resistances  $R_1$ ,  $R_2$  and  $R_3$  be connected in series (Figure 4.6). Let the current flowing through them be  $I$ . According to Ohm’s Law, the potential differences  $V_1$ ,  $V_2$  and  $V_3$  across  $R_1$ ,  $R_2$  and  $R_3$  respectively, are given by:

$$V_1 = I R_1 \tag{4.7}$$

$$V_2 = I R_2 \tag{4.8}$$

$$V_3 = I R_3 \tag{4.9}$$

The sum of the potential differences across the ends of each resistor is given by:

$$V = V_1 + V_2 + V_3$$

Using equations (4.7), (4.8) and (4.9), we get

$$V = I R_1 + I R_2 + I R_3 \quad (4.10)$$

The effective resistor is a single resistor, which can replace the resistors effectively, so as to allow the same current through the electric circuit. Let, the effective resistance of the series-combination of the resistors, be  $R_s$ . Then,

$$V = I R_s \quad (4.11)$$

Combining equations (4.10) and (4.11), you get,

$$\begin{aligned} I R_s &= I R_1 + I R_2 + I R_3 \\ R_s &= R_1 + R_2 + R_3 \end{aligned} \quad (4.12)$$

Thus, you can understand that when a number of resistors are connected in series, their equivalent resistance or effective resistance is equal to the sum of the individual resistances. When 'n' resistors of equal resistance R are connected in series, the equivalent resistance is 'n R'.

$$\text{i.e., } R_s = n R$$

**The equivalent resistance in a series combination is greater than the highest of the individual resistances.**

#### Solved Problem-5

Three resistors of resistances 5 ohm, 3 ohm and 2 ohm are connected in series with 10 V battery. Calculate their effective resistance and the current flowing through the circuit.

**Solution:**

$$R_1 = 5 \Omega, R_2 = 3 \Omega, R_3 = 2 \Omega, V = 10 \text{ V}$$

$$R_s = R_1 + R_2 + R_3, R_s = 5 + 3 + 2 = 10, \text{ hence } R_s = 10 \Omega$$

$$\text{The current, } I = \frac{V}{R_s} = \frac{10}{10} = 1 \text{ A}$$

#### 4.7.2 Resistances in Parallel

A parallel circuit has two or more loops through which current can pass. If the circuit is disconnected in one of the loops, the current can still pass through the other loop(s). The wiring in a house consists of parallel circuits.

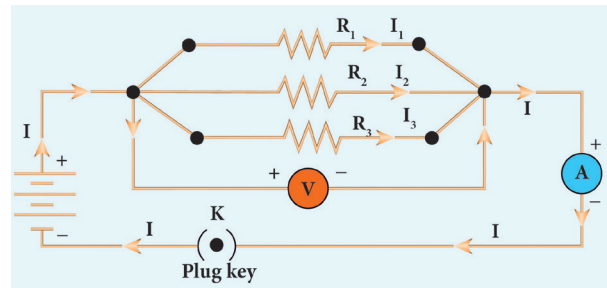

Figure 4.7 Parallel connections of resistors

Consider that three resistors  $R_1$ ,  $R_2$  and  $R_3$  are connected across two common points A and B. The potential difference across each resistance is the same and equal to the potential difference between A and B. This is measured using the voltmeter. The current  $I$  arriving at A divides into three branches  $I_1$ ,  $I_2$  and  $I_3$  passing through  $R_1$ ,  $R_2$  and  $R_3$  respectively.

According to the Ohm's law, you have,

$$I_1 = \frac{V}{R_1} \quad (4.13)$$

$$I_2 = \frac{V}{R_2} \quad (4.14)$$

$$I_3 = \frac{V}{R_3} \quad (4.15)$$

The total current through the circuit is given by

$$I = I_1 + I_2 + I_3$$

Using equations (4.13), (4.14) and (4.15), you get

$$I = \frac{V}{R_1} + \frac{V}{R_2} + \frac{V}{R_3} \quad (4.16)$$

Let the effective resistance of the parallel combination of resistors be  $R_p$ . Then,

$$I = \frac{V}{R_p} \quad (4.17)$$

Combining equations (4.16) and (4.17), you have

$$\frac{V}{R_p} = \frac{V}{R_1} + \frac{V}{R_2} + \frac{V}{R_3}$$

$$\frac{1}{R_p} = \frac{1}{R_1} + \frac{1}{R_2} + \frac{1}{R_3} \quad (4.18)$$



Thus, when a number of resistors are connected in parallel, the sum of the reciprocals of the individual resistances is equal to the reciprocal of the effective or equivalent resistance. When 'n' resistors of equal resistances R are connected in parallel, the equivalent resistance is  $\frac{R}{n}$ .

$$\text{i.e., } \frac{1}{R_p} = \frac{1}{R} + \frac{1}{R} + \frac{1}{R} \dots + \frac{1}{R} = \frac{n}{R}$$

$$\text{Hence, } R_p = \frac{R}{n}$$

*The equivalent resistance in a parallel combination is less than the lowest of the individual resistances.*

### 4.7.3 Series Connection of Parallel Resistors

If you consider the connection of a set of parallel resistors that are connected in series, you get a series – parallel circuit. Let  $R_1$  and  $R_2$  be connected in parallel to give an effective resistance of  $R_{p1}$ . Similarly, let  $R_3$  and  $R_4$  be connected in parallel to give an effective resistance of  $R_{p2}$ . Then, both of these parallel segments are connected in series (Figure 4.8).

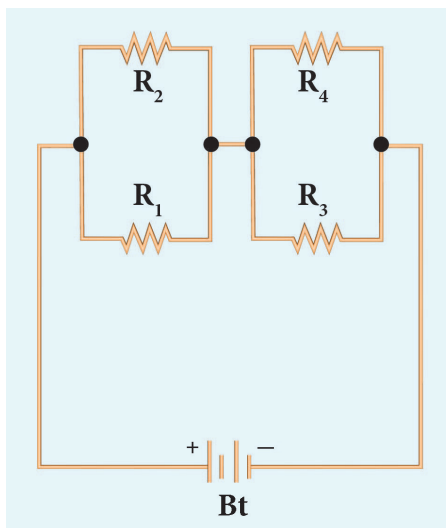

Figure 4.8 Series-parallel combination of resistors

Using equation (4.18), you get

$$\frac{1}{R_{p1}} = \frac{1}{R_1} + \frac{1}{R_2}$$

$$\frac{1}{R_{p2}} = \frac{1}{R_3} + \frac{1}{R_4}$$

Finally, using equation (4.12), the net effective resistance is given by  $R_{total} = R_{p1} + R_{p2}$

### 4.7.4 Parallel Connection of Series Resistors

If you consider a connection of a set of series resistors connected in a parallel circuit, you get a parallel-series circuit. Let  $R_1$  and  $R_2$  be connected in series to give an effective resistance of  $R_{s1}$ . Similarly, let  $R_3$  and  $R_4$  be connected in series to give an effective resistance of  $R_{s2}$ . Then, both of these serial segments are connected in parallel (Figure 4.9).

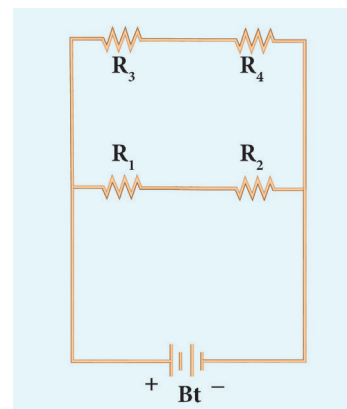

Figure 4.9 Parallel-series combination of resistors

Using equation (4.12), you get

$$R_{s1} = R_1 + R_2, \quad R_{s2} = R_3 + R_4$$

Finally, using equation (4.18), the net effective resistance is given by

$$\frac{1}{R_{total}} = \frac{1}{R_{s1}} + \frac{1}{R_{s2}}$$

### 4.7.5 Difference between series and parallel connections

The difference between series and parallel circuits may be summed as follows in Table 4.3

**Table 4.3** Difference between series and parallel circuit

S. No.	CRITERIA	SERIES	PARALLEL
1	Equivalent resistance	More than the highest resistance.	Less than the lowest resistance.
2	Amount of current	Current is less as effective resistance is more.	Current is more as effective resistance is less.
3	Switching ON/OFF	If one appliance is disconnected, others also do not work.	If one appliance is disconnected, others will work independently.

### 4.8 HEATING EFFECT OF CURRENT

Have you ever touched the motor casing of a fan, which has been used for a few hours continuously? What do you observe? The motor casing is warm. This is due to the heating effect of current. The same can be observed by touching a bulb, which was used for a long duration. Generally, a source of electrical energy can develop a potential difference across a resistor, which is connected to that source. This potential difference constitutes a current through the resistor. For continuous drawing of current, the source has to continuously spend its energy. A part of the energy from the source can be converted into useful work and the rest will be converted into heat energy. Thus, the passage of electric current through a wire, results in the production of heat. This phenomenon is called heating effect of current. This heating effect of current is used in devices like electric heater, electric iron, etc.

#### 4.8.1 Joule’s Law of Heating

Let ‘I’ be the current flowing through a resistor of resistance ‘R’, and ‘V’ be the potential difference across the resistor. The charge flowing through the circuit for a time interval ‘t’ is ‘Q’.

The work done in moving the charge Q across the ends of the resistor with a potential difference of V is VQ. This energy spent by the source gets dissipated in the resistor as heat. Thus, the heat produced in the resistor is:

$$H = W = VQ$$

You know that the relation between the charge and current is  $Q = I t$ . Using this, you get

$$H = V I t \quad (4.19)$$

From Ohm’s Law,  $V = I R$ . Hence, you have

$$H = I^2 R t \quad (4.20)$$

This is known as Joule’s law of heating.

Joule’s law of heating states that the heat produced in any resistor is:

- directly proportional to the square of the current passing through the resistor.
- directly proportional to the resistance of the resistor.
- directly proportional to the time for which the current is passing through the resistor.

#### 4.8.2 Applications of Heating Effect

##### 1. Electric Heating Device:

The heating effect of electric current is used in many home appliances such as electric iron, electric toaster, electric oven, electric heater, geyser, etc. In these appliances Nichrome, which is an alloy of Nickel and Chromium is used as the heating element. Why? Because:

- (i) it has high resistivity, (ii) it has a high melting point, (iii) it is not easily oxidized.

##### 2. Fuse Wire:

The fuse wire is connected in series, in an electric circuit. When a large current passes through the circuit, the fuse wire melts due to Joule’s heating effect and hence the circuit gets disconnected. Therefore, the circuit and the

electric appliances are saved from any damage. The fuse wire is made up of a material whose melting point is relatively low.

### 3. Filament in bulbs:

In electric bulbs, a small wire is used, known as filament. The filament is made up of a material whose melting point is very high. When current passes through this wire, heat is produced in the filament. When the filament is heated, it glows and gives out light. Tungsten is the commonly used material to make the filament in bulbs.

#### Solved Problem-6

An electric heater of resistance  $5 \Omega$  is connected to an electric source. If a current of  $6 \text{ A}$  flows through the heater, then find the amount of heat produced in 5 minutes.

#### Solution:

Given resistance  $R = 5 \Omega$ , Current  $I = 6 \text{ A}$ ,  
Time  $t = 5 \text{ minutes} = 5 \times 60 \text{ s} = 300 \text{ s}$

Amount of heat produced,  $H = I^2 R t$ ,  
 $H = 6^2 \times 5 \times 300$ . Hence,  $H = 54000 \text{ J}$

## 4.9 ELECTRIC POWER

In general, power is defined as the rate of doing work or rate of spending energy. Similarly, the electric power is defined as the rate of consumption of electrical energy. It represents the rate at which the electrical energy is converted into some other form of energy.

Suppose a current 'I' flows through a conductor of resistance 'R' for a time 't', then the potential difference across the two ends of the conductor is 'V'. The work done 'W' to move the charge across the ends of the conductor is given by the equation (4.19) as follows:

$$W = V I t, \text{ Power } P = \frac{\text{Work}}{\text{Time}} = \frac{V I t}{t}$$

$$P = V I \quad (4.21)$$

Thus, the electric power is the product of the electric current and the potential difference due to which the current passes in a circuit.

### 4.9.1 Unit of Electric Power

The SI unit of electric power is watt. When a current of 1 ampere passes across the ends of a conductor, which is at a potential difference of 1 volt, then the electric power is

$$P = 1 \text{ volt} \times 1 \text{ ampere} = 1 \text{ watt}$$

Thus, one watt is the power consumed when an electric device is operated at a potential difference of one volt and it carries a current of one ampere. A larger unit of power, which is more commonly used is kilowatt.



#### HORSE POWER:

*The horse power (hp) is a unit in the foot-pound-second (fps) or English system, sometimes used to express the electric power. It is equal to 746 watt.*

### 4.9.2 Consumption of electrical energy

Electricity is consumed both in houses and industries. Consumption of electricity is based on two factors: (i) Amount of electric power and (ii) Duration of usage. Electrical energy consumed is taken as the product of electric power and time of usage. For example, if 100 watt of electric power is consumed for two hours, then the power consumed is  $100 \times 2 = 200 \text{ watt hour}$ . Consumption of electrical energy is measured and expressed in watt hour, though its SI unit is watt second. In practice, a larger unit of electrical energy is needed. This larger unit is kilowatt hour (kWh). One kilowatt hour is otherwise known as one unit of electrical energy. One kilowatt hour means that an electric power of 1000 watt has been utilized for an hour. Hence,

$$1 \text{ kWh} = 1000 \text{ watt hour} = 1000 \times (60 \times 60) \text{ watt second} = 3.6 \times 10^6 \text{ J}$$

## 4.10 DOMESTIC ELECTRIC CIRCUITS

The electricity produced in power stations is distributed to all the domestic and industrial consumers through overhead and underground

cables. The diagram, which shows the general scheme of a domestic electric circuit, is given in Figure 4.10.

In our homes, electricity is distributed through the domestic electric circuits wired by the electricians. The first stage of the domestic circuit is to bring the power supply to the main-box from a distribution panel, such as a transformer. The important components of the main-box are: (i) a fuse box and (ii) a meter. The meter is used to record the consumption of electrical energy. The fuse box contains either a fuse wire or a miniature circuit breaker (MCB). The function of the fuse wire or a MCB is to protect the house hold electrical appliances from overloading due to excess current.

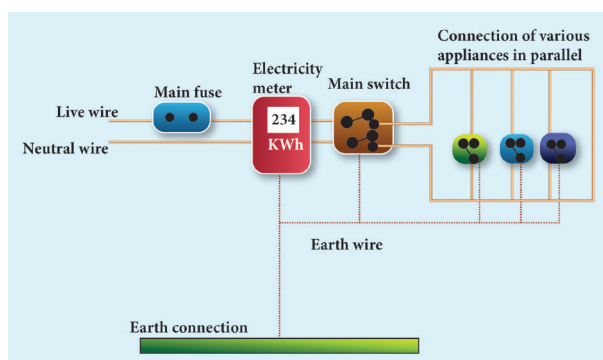

Figure 4.10 Domestic electric circuit

You have learnt about a fuse wire in section 4.8.2. An MCB is a switching device, which can be activated automatically as well as manually. It has a spring attached to the switch, which is attracted by an electromagnet when an excess current passes through the circuit. Hence, the circuit is broken and the protection of the appliance is ensured. Figure 4.11 represents a fuse and an MCB.

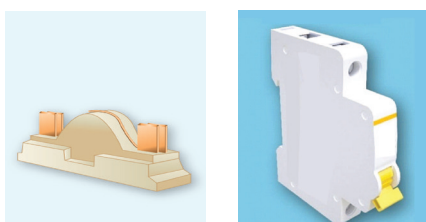

Figure 4.11 A fuse and an MCB

The electricity is brought to houses by two insulated wires. Out of these two wires, one wire has a red insulation and is called the 'live wire'. The other wire has a black insulation and is called the 'neutral wire'. The electricity supplied to your house is actually an alternating current having an electric potential of 220 V. Both, the live wire and the neutral wire enter into a box where the main fuse is connected with the live wire. After the electricity meter, these wires enter into the main switch, which is used to discontinue the electricity supply whenever required. After the main switch, these wires are connected to live wires of two separate circuits. Out of these two circuits, one circuit is of a 5 A rating, which is used to run the electric appliances with a lower power rating, such as tube lights, bulbs and fans. The other circuit is of a 15 A rating, which is used to run electric appliances with a high power rating, such as air-conditioners, refrigerators, electric iron and heaters. It should be noted that all the circuits in a house are connected in parallel, so that the disconnection of one circuit does not affect the other circuit. One more advantage of the parallel connection of circuits is that each electric appliance gets an equal voltage.



In India, domestic circuits are supplied with an alternating current of potential 220/230V and frequency 50 Hz. In countries like USA and UK, domestic circuits are supplied with an alternating current of potential 110/120 V and frequency 60 Hz.

#### 4.10.1 Overloading and Short circuiting

The fuse wire or MCB will disconnect the circuit in the event of an overloading and short circuiting. Over loading happens when a large number of appliances are connected in series to

the same source of electric power. This leads to a flow of excess current in the electric circuit. When the amount of current passing through a wire exceeds the maximum permissible limit, the wires get heated to such an extent that a fire may be caused. This is known as overloading. When a live wire comes in contact with a neutral wire, it causes a 'short circuit'. This happens when the insulation of the wires get damaged due to temperature changes or some external force. Due to a short circuit, the effective resistance in the circuit becomes very small, which leads to the flow of a large current through the wires. This results in heating of wires to such an extent that a fire may be caused in the building.

#### 4.10.2 Earthing

In domestic circuits, a third wire called the earth wire having a green insulation is usually connected to the body of the metallic electric appliance. The other end of the earth wire is connected to a metal tube or a metal electrode, which is buried into the Earth. This wire provides a low resistance path to the electric current. The earth wire sends the current from the body of the appliance to the Earth, whenever a live wire accidentally touches the body of the metallic electric appliance. Thus, the earth wire serves as a protective conductor, which saves us from electric shocks.

### 4.11 LED BULB

An LED bulb is a semiconductor device that emits visible light when an electric current passes through it. The colour of the emitted light will depend on the type of materials used. With the help of the chemical compounds like Gallium Arsenide and Gallium Phosphide, the manufacturer can produce LED bulbs that radiates red, green, yellow and orange colours. Displays in digital watches and calculators, traffic signals,

street lights, decorative lights, etc., are some examples for the use of LEDs.

#### 4.11.1 Seven Segment Display

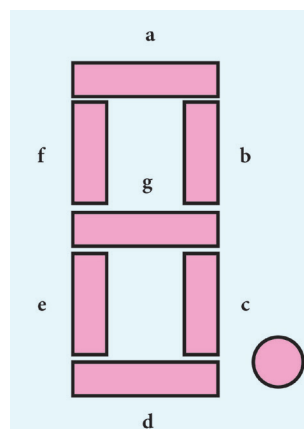

Figure 4.12 Seven segment display

A 'Seven Segment Display' is the display device used to give an output in the form of numbers or text. It is used in digital meters, digital clocks, micro wave ovens, etc. It consists of 7 segments of LEDs in the form of the digit 8. These seven LEDs are named as a, b, c, d, e, f and g (Figure 4.12). An extra 8<sup>th</sup> LED is used to display a dot.

#### 4.11.2 Merits of a LED bulb

1. As there is no filament, there is no loss of energy in the form of heat. It is cooler than the incandescent bulb.
2. In comparison with the fluorescent light, the LED bulbs have significantly low power requirement.
3. It is not harmful to the environment.
4. A wide range of colours is possible here.
5. It is cost-efficient and energy efficient.
6. Mercury and other toxic materials are not required.

*One way of overcoming the energy crisis is to use more LED bulbs.*

### 4.12 LED TELEVISION

LED Television is one of the most important applications of Light Emitting Diodes. An LED TV is actually an LCD TV (Liquid Crystal Display) with LED display.

An LED display uses LEDs for backlight and an array of LEDs act as pixels. LEDs emitting white light are used in monochrome (black and white) TV; Red, Green and Blue (RGB) LEDs are used in colour television. The first LED television screen was developed by James P. Mitchell in 1977. It was a monochromatic display. But, after about three decades, in 2009, SONY introduced the first commercial LED Television.

#### 4.12.1 Advantages of LED television

- It has brighter picture quality.
- It is thinner in size.
- It uses less power and consumes very less energy.
- Its life span is more.
- It is more reliable.

#### Points to Remember

- ❖ The magnitude of current is defined as the rate of flow of charges in a conductor.
- ❖ The SI unit of electric current is ampere (A).
- ❖ The SI unit of electric potential and potential difference is volt (V).
- ❖ An electric circuit is a network of electrical components, which forms a continuous and closed path for an electric current to pass through it.
- ❖ The parameters of conductors like its length, area of cross-section and material, affect the resistance of the conductor.
- ❖ SI unit of electrical resistivity is ohm metre. The resistivity is a constant for a given material.
- ❖ The reciprocal of electrical resistivity of a material is called its electrical conductivity.
 
$$\sigma = \frac{1}{\rho}$$
- ❖ The passage of electric current through a wire results in the production of heat.

This phenomenon is called heating effect of current.

- ❖ One horse power is equal to 746 watts.
- ❖ The function of a fuse wire or a MCB is to protect the house hold electrical appliances from excess current due to overloading or a short circuit.

#### Solved Problems

- Two bulbs are having the ratings as 60 W, 220 V and 40 W, 220 V respectively. Which one has a greater resistance?

**Solution:**

$$\text{Electric power } P = \frac{V^2}{R}$$

For the same value of V, R is inversely proportional to P.

Therefore, lesser the power, greater the resistance

Hence, the bulb with 40 W, 220 V rating has a greater resistance.

- Calculate the current and the resistance of a 100 W, 200 V electric bulb in an electric circuit.

**Solution:**

$$\text{Power } P = 100 \text{ W and Voltage } V = 200 \text{ V}$$

$$\text{Power } P = V I$$

$$\text{So, Current, } I = \frac{P}{V} = \frac{100}{200} = 0.5 \text{ A}$$

$$\text{Resistance, } R = \frac{V}{I} = \frac{200}{0.5} = 400 \Omega$$

- In the circuit diagram given below, three resistors  $R_1$ ,  $R_2$  and  $R_3$  of 5  $\Omega$ , 10  $\Omega$  and 20  $\Omega$  respectively are connected as shown. Calculate:

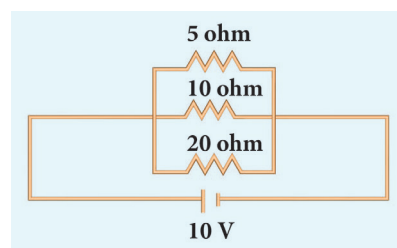

- A) Current through each resistor
- B) Total current in the circuit
- C) Total resistance in the circuit

$$\frac{1}{R_p} = \frac{7}{20}$$

Hence,  $R_p = \frac{20}{7} = 2.857 \Omega$

**Solution:**

A) Since the resistors are connected in parallel, the potential difference across each resistor is same (i.e.  $V=10V$ )

Therefore, the current through  $R_1$  is,

$$I_1 = \frac{V}{R_1} = \frac{10}{5} = 2 \text{ A}$$

Current through  $R_2 = I_2 = \frac{V}{R_2} = \frac{10}{10} = 1 \text{ A}$

Current through  $R_3 = I_3 = \frac{V}{R_3} = \frac{10}{20} = 0.5 \text{ A}$

B) Total current in the circuit,  $I = I_1 + I_2 + I_3$   
 $= 2 + 1 + 0.5 = 3.5 \text{ A}$

C) Total resistance in the circuit  $\frac{1}{R_p} = \frac{1}{R_1} + \frac{1}{R_2} + \frac{1}{R_3}$   
 $= \frac{1}{5} + \frac{1}{10} + \frac{1}{20}$   
 $= \frac{4 + 2 + 1}{20}$

4. Three resistors of  $1 \Omega$ ,  $2 \Omega$  and  $4 \Omega$  are connected in parallel in a circuit. If a  $1 \text{ A}$  resistor draws a current of  $1 \text{ A}$ , find the current through the other two resistors.

**Solution:**

$R_1 = 1 \Omega$ ,  $R_2 = 2 \Omega$ ,  $R_3 = 4 \Omega$  Current  $I_1 = 1 \text{ A}$

The potential difference across the  $1 \Omega$  resistor  
 $= I_1 R_1 = 1 \times 1 = 1 \text{ V}$

Since, the resistors are connected in parallel in the circuit, the same potential difference will exist across the other resistors also.

So, the current in the  $2 \Omega$  resistor,  $\frac{V}{R_2} = \frac{1}{2} = 0.5 \text{ A}$

Similarly, the current in the  $4 \Omega$  resistor,

$$\frac{V}{R_3} = \frac{1}{4} = 0.25 \text{ A}$$



**TEXTBOOK EVALUATION**



**I. Choose the best answer**

1. Which of the following is correct?
  - a) Rate of change of charge is electrical power.
  - b) Rate of change of charge is current.
  - c) Rate of change of energy is current.
  - d) Rate of change of current is charge.
2. SI unit of resistance is
  - a) mho
  - b) joule
  - c) ohm
  - d) ohm meter
3. In a simple circuit, why does the bulb glow when you close the switch?
  - a) The switch produces electricity.
  - b) Closing the switch completes the circuit.
  - c) Closing the switch breaks the circuit.
  - d) The bulb is getting charged.
4. Kilowatt hour is the unit of
  - a) resistivity
  - b) conductivity
  - c) electrical energy
  - d) electrical power

**II. Fill in the blanks**

1. When a circuit is open, \_\_\_\_\_ cannot pass through it.
2. The ratio of the potential difference to the current is known as \_\_\_\_\_.
3. The wiring in a house consists of \_\_\_\_\_ circuits.
4. The power of an electric device is a product of \_\_\_\_\_ and \_\_\_\_\_.
5. LED stands for \_\_\_\_\_.

**III. State whether the following statements are true or false: If false correct the statement.**

1. Ohm's law states the relationship between power and voltage.
2. MCB is used to protect house hold electrical appliances.
3. The SI unit for electric current is the coulomb.
4. One unit of electrical energy consumed is equal to 1000 kilowatt hour.
5. The effective resistance of three resistors connected in series is lesser than the lowest of the individual resistances.

**IV. Match the items in column-I to the items in column-II:**

Column - I	Column - II
(i) electric current	(a) volt
(ii) potential difference	(b) ohm meter
(iii) specific resistance	(c) watt
(iv) electrical power	(d) joule
(v) electrical energy	(e) ampere

**V. Assertion and reason type questions:**

**Mark the correct choice as**

- a) if both the assertion and the reason are true and the reason is the correct explanation of the assertion.

- b) if both the assertion and the reason are true, but the reason is not the correct explanation of the assertion.
- c) if the assertion is true, but the reason is false.
- d) if the assertion is false, but the reason is true.

1. **Assertion:** Electric appliances with a metallic body have three wire connections.

**Reason:** Three pin connections reduce heating of the connecting wires

2. **Assertion:** In a simple battery circuit the point of highest potential is the positive terminal of the battery.

**Reason:** The current flows towards the point of the highest potential

3. **Assertion:** LED bulbs are far better than incandescent bulbs.

**Reason:** LED bulbs consume less power than incandescent bulbs.

**VI. Very short answer questions.**

1. Define the unit of current.
2. What happens to the resistance, as the conductor is made thicker?
3. Why is tungsten metal used in bulbs, but not in fuse wires?
4. Name any two devices, which are working on the heating effect of the electric current.

**VII. Short answer questions**

1. Define electric potential and potential difference.
2. What is the role of the earth wire in domestic circuits?
3. State Ohm's law.
4. Distinguish between the resistivity and conductivity of a conductor.



5. What connection is used in domestic appliances and why?

**VIII. Long answer questions.**

1. With the help of a circuit diagram derive the formula for the resultant resistance of three resistances connected: a) in series and b) in parallel
2. a) What is meant by electric current?  
b) Name and define its unit.  
c) Which instrument is used to measure the electric current? How should it be connected in a circuit?
3. a) State Joule's law of heating.  
b) An alloy of nickel and chromium is used as the heating element. Why?  
c) How does a fuse wire protect electrical appliances?
4. Explain about domestic electric circuits. (circuit diagram not required)
5. a) What are the advantages of LED TV over the normal TV?  
b) List the merits of LED bulb.

**IX. Numerical problems:**

1. An electric iron consumes energy at the rate of 420 W when heating is at the maximum rate and 180 W when heating is at the minimum rate. The applied voltage is 220 V. What is the current in each case?
2. A 100 watt electric bulb is used for 5 hours daily and four 60 watt bulbs are used for 5 hours daily. Calculate the energy consumed (in kWh) in the month of January.
3. A torch bulb is rated at 3 V and 600 mA. Calculate its
  - a) power
  - b) resistance
  - c) energy consumed if it is used for 4 hour.

4. A piece of wire having a resistance R is cut into five equal parts.
  - a) How will the resistance of each part of the wire change compared with the original resistance?
  - b) If the five parts of the wire are placed in parallel, how will the resistance of the combination change?
  - c) What will be ratio of the effective resistance in series connection to that of the parallel connection?

**X. HOTS:**

1. Two resistors when connected in parallel give the resultant resistance of 2 ohm; but when connected in series the effective resistance becomes 9 ohm. Calculate the value of each resistance.
2. How many electrons are passing per second in a circuit in which there is a current of 5 A?
3. A piece of wire of resistance 10 ohm is drawn out so that its length is increased to three times its original length. Calculate the new resistance.



**REFERENCE BOOKS**

1. Electrodynamics by Griffiths
2. Fundamentals of Electric Circuits by Charles Alexander



**INTERNET RESOURCES**

- <https://www.elprocus.com/basic-electrical-circuits-and-their-working-for-electrical-engineers/>
- <https://www.physicsclassroom.com/calcpad/circuits>

# CONCEPT MAP

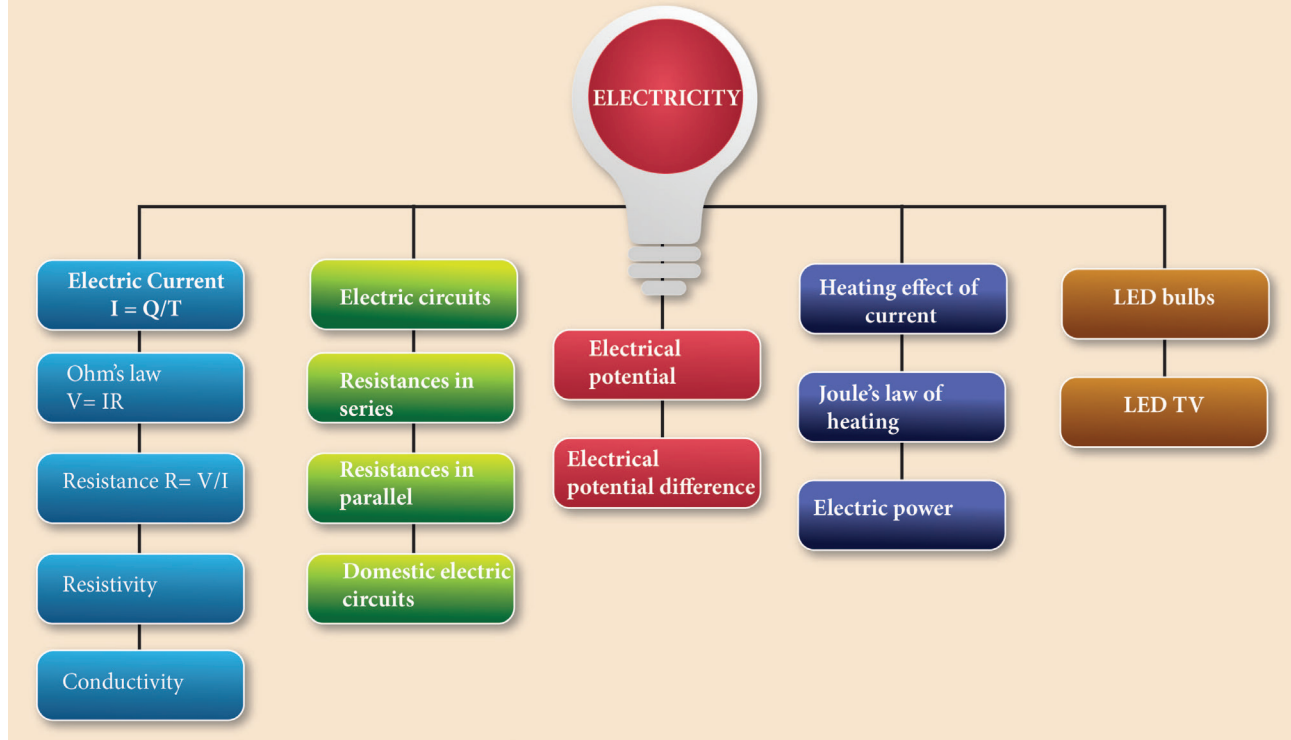

## ICT CORNER

## Ohm's Law

In this activity you will be able to (i) verify Ohm's law (ii) understand the relation between current, voltage and resistance.

- Steps**
- Open the browser and type "olabs.edu.in" in the address bar. Click physics tab and then click "Ohm's law and resistance" under class 10 section. Go to "simulator" tab to do the experiment.
  - Construct the electric circuit as per the connection diagram by clicking "show circuit diagram" tab. You can connect wires between electric component by dragging the mouse between the component.
  - Switch on the key and note down the voltage ( $V$ ) and current ( $I$ ). Find the value of resistance using the formula  $R = \frac{V}{I}$ . Repeat the experiment for different values of voltage and current. Check whether the resistance remains constant.
  - Find the value of Resistance/(length (in Cm)). Enter the value of resistance and resistance per unit length in the result. Verify the answer.

Note:

1. One time sign up is needed to do simulation. Then login using that username and password.
2. Read theory, procedure and animation to get the theory by clicking the corresponding tab.

**Link**

URL:<http://amrita.olabs.edu.in/?sub=1&brch=4&sim=99&cnt=4>





# ACOUSTICS



## Learning Objectives



By the end of this section, the students will be able to:

- ◆ Understand how sound is produced and transmitted.
- ◆ Relate the speed of sound, its frequency, and its wavelength.
- ◆ Know the speed of sound in various media.
- ◆ Explain the factors affecting the speed of sound in a gaseous medium.
- ◆ Demonstrate the phenomenon of reflection of sound.
- ◆ Determine the speed of sound using the method of echo.
- ◆ Understand Doppler Effect.
- ◆ Solve numerical problems related to the above topics.

## INTRODUCTION

Sound plays a major role in our lives. We communicate with each other mainly through sound. In our daily life, we hear a variety of sounds produced by different sources like humans, animals, vehicle horns, etc. Hence, it becomes inevitable to understand how sound is produced, how it is propagated and how you hear the sound from various sources. It is sometimes misinterpreted that acoustics only deals with musical instruments and design of auditoria and concert halls. But, acoustics is a branch of physics that deals with production, transmission, reception, control, and effects of sound. You have studied about propagation and properties of sound waves in IX standard. In this lesson we will study about reflection of sound waves, Echo and Doppler effect.

## 5.1 SOUND WAVES

When you think about sound, the questions that arise in your minds are: How is sound produced? How does sound reach our ears from various sources? What is sound? Is it a force or energy? Let us answer all these questions.

By touching a ringing bell or a musical instrument while it is producing music, you can conclude that sound is produced by vibrations. The vibrating bodies produce energy in the form of waves, which are nothing but sound waves (Figure 5.1).

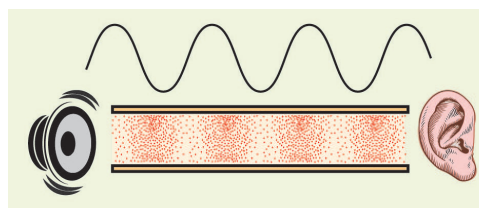

**Figure 5.1** Production of sound waves

Suppose you and your friend are on the Moon. Will you be able to hear any sound produced by your friend? As the Moon does not have air, you will not be able to hear any sound produced by your friend. Hence, you understand that the sound produced due to the vibration of different bodies needs a material medium like air, water, steel, etc, for its propagation. Hence, sound can propagate through a gaseous medium or a liquid medium or a solid medium.

**ACTIVITY 1**

Take a squeaky toy or old mobile phone and put it inside a plastic bag. Seal the bag with the help of a candle or with a thread. Fill a bucket with water and place the bag in the water bucket and squeeze the toy or ring the mobile. You will hear a low sound. Now place your ear against the side of the bucket and squeeze the toy or ring the mobile phone again. You will hear a louder sound.

**5.1.1 Longitudinal Waves**

Sound waves are longitudinal waves that can travel through any medium (solids, liquids, gases) with a speed that depends on the properties of the medium. As sound travels through a medium, the particles of the medium vibrate along the direction of propagation of the wave. This displacement involves the longitudinal displacements of the individual molecules from their mean positions. This results in a series of high and low pressure regions called compressions and rarefactions as shown in figure 5.2.

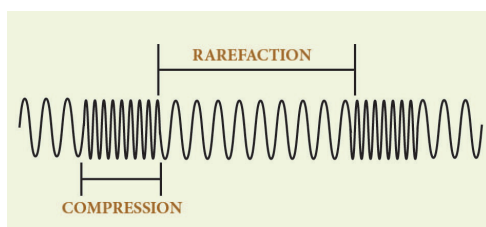

Figure 5.2 Sound propagates as longitudinal waves

**5.1.2 Categories of sound waves based on their frequencies**

(i) **Audible waves** – These are sound waves with a frequency ranging between 20 Hz and 20,000 Hz. These are generated by vibrating bodies such as vocal cords, stretched strings etc.

(ii) **Infrasonic waves** – These are sound waves with a frequency below 20 Hz that cannot be heard by the human ear. e.g., waves produced during earth quake, ocean waves, sound produced by whales, etc.

(iii) **Ultrasonic waves** – These are sound waves with a frequency greater than 20 kHz, Human ear cannot detect these waves, but certain creatures like mosquito, dogs, bats, dolphins can detect these waves. e.g., waves produced by bats.

**5.1.3 Difference between the sound and light waves**

S.No.	SOUND	LIGHT
1	Medium is required for the propagation.	Medium is not required for the propagation.
2	Sound waves are longitudinal.	Light waves are transverse.
3	Wavelength ranges from 1.65 cm to 1.65 m.	Wavelength ranges from $4 \times 10^{-7}$ m to $7 \times 10^{-7}$ m.
4	Sound waves travel in air with a speed of about $340 \text{ ms}^{-1}$ at NTP.	Light waves travel in air with a speed of $3 \times 10^8 \text{ ms}^{-1}$ .

**5.1.4 Velocity of sound waves**

When you talk about the velocity associated with any wave, there are two velocities, namely particle velocity and wave velocity. SI unit of velocity is  $\text{ms}^{-1}$

**Particle velocity:**

The velocity with which the particles of the medium vibrate in order to transfer the energy in the form of a wave is called particle velocity.

**Wave velocity:**

The velocity with which the wave travels through the medium is called wave velocity. In other words, the distance travelled by a sound wave in unit time is called the velocity of a sound wave.

$$\therefore \text{Velocity} = \frac{\text{Distance}}{\text{Time taken}}$$

If the distance travelled by one wave is taken as one wavelength ( $\lambda$ ) and, the time taken for this propagation is one time period (T), then, the expression for velocity can be written as

$$\therefore V = \frac{\lambda}{T} \quad (5.1)$$

Therefore, velocity can be defined as the distance travelled per second by a sound wave. Since, Frequency ( $n$ ) =  $1/T$ , equation (5.1) can be written as

$$V = n\lambda \quad (5.2)$$

Velocity of a sound wave is maximum in solids because they are more elastic in nature than liquids and gases. Since, gases are least elastic in nature, the velocity of sound is the least in a gaseous medium.

So,  $v_s > v_l > v_g$

**5.1.5 Factors affecting velocity of sound**

In the case of solids, the elastic properties and the density of the solids affect the velocity of sound waves. Elastic property of solids is characterized by their elastic moduli. The speed of sound is directly proportional to the square root of the elastic modulus and inversely proportional to the square root of the density. Thus the velocity of sound in solids decreases as the density increases whereas the velocity of sound increases when the elasticity of the material increases. In the case of gases, the following factors affect the velocity of sound waves.

**Effect of density:** The velocity of sound in a gas is inversely proportional to the square root of the density of the gas. Hence, the velocity decreases as the density of the gas increases.

$$v \propto \sqrt{\frac{1}{d}}$$

**Effect of temperature:** The velocity of sound in a gas is directly proportional to the square root of its temperature. The velocity of sound in a gas increases with the increase in temperature.  $v \propto \sqrt{T}$ . Velocity at temperature T is given by the following equation:

$$v_T = (v_0 + 0.61 T) \text{ ms}^{-1}$$

Here,  $v_0$  is the velocity of sound in the gas at  $0^\circ \text{C}$ . For air,  $v_0 = 331 \text{ ms}^{-1}$ . Hence, the velocity of sound changes by  $0.61 \text{ ms}^{-1}$  when the temperature changes by one degree celsius.

**Effect of relative humidity:** When humidity increases, the speed of sound increases. That is why you can hear sound from long distances clearly during rainy seasons.

Speed of sound waves in different media are given in table 5.1.

**Table 5.1 Speed of sound in different media**

S. No.	Nature of the medium	Name of the Medium	Speed of sound (in $\text{ms}^{-1}$ )
1	Solid	Copper	5010
2		Iron	5950
3		Aluminium	6420
4	Liquid	Kerosene	1324
5		Water	1493
6		Sea water	1533
7	Gas	Air (at $0^\circ \text{C}$ )	331
8		Air (at $20^\circ \text{C}$ )	343

**Example Problem 5.1**

- At what temperature will the velocity of sound in air be double the velocity of sound in air at  $0^\circ \text{C}$ ?

**Solution:**

Let  $T^\circ\text{C}$  be the required temperature. Let  $v_1$  and  $v_2$  be the velocity of sound at temperatures  $T_1\text{K}$  and  $T_2\text{K}$  respectively.  $T_1 = 273\text{K}$  ( $0^\circ\text{C}$ ) and  $T_2 = (T^\circ\text{C} + 273)\text{K}$

$$\frac{v_2}{v_1} = \sqrt{\frac{T_2}{T_1}} = \sqrt{\frac{273 + T}{273}} = 2$$

Here, it is given that,  $v_2 / v_1 = 2$ .

$$\text{So, } \frac{273 + T}{273} = 4$$

$$T = (273 \times 4) - 273 = 819^\circ\text{C}$$

**5.2 REFLECTION OF SOUND**

When you speak in an empty room, you hear a soft repetition of your voice. This is nothing but the reflection of the sound waves that you produce. Let us discuss about the reflection of sound in detail through the following activity.

When sound waves travel in a given medium and strike the surface of another medium, they can be bounced back into the first medium. This phenomenon is known as reflection. In simple the reflection and refraction of sound is actually similar to the reflection of light. Thus, the bouncing of sound waves from the interface between two media is termed as the reflection of sound. The waves that strike the interface are termed as the incident wave and the waves that bounce back are termed as the reflected waves, as shown in Figure 5.3

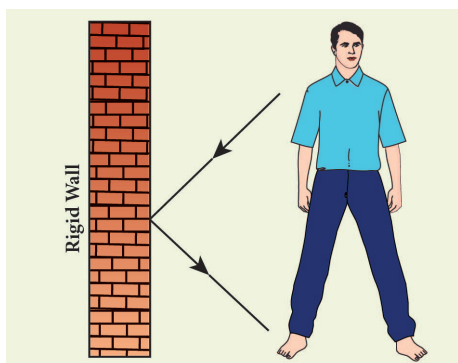

Figure 5.3 Reflection of sound

**5.2.1 Laws of reflection**

Like light waves, sound waves also obey some fundamental laws of reflection. The following two laws of reflection are applicable to sound waves as well.



- ❖ The incident wave, the normal to the reflecting surface and the reflected wave at the point of incidence lie in the same plane.
- ❖ The angle of incidence  $\angle i$  is equal to the angle of reflection  $\angle r$ .

These laws can be observed from Figure 5.4.

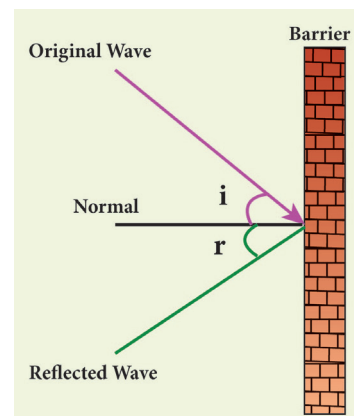

Figure 5.4 Laws of reflection

In the above Figure 5.4, the sound waves that travel towards the reflecting surface are called the incident waves. The sound waves bouncing back from the reflecting surface are called reflected waves. For all practical purposes, the point of incidence and the point of reflection is the same point on the reflecting surface.

A perpendicular line drawn at the point of incidence is called the normal. The angle which the incident sound wave makes with the normal is called the angle of incidence, 'i'. The angle which the reflected wave makes with the normal is called the angle of reflection, 'r'.



**Acoustical wonder of Golconda fort (Hyderabad, Telangana)**

The Clapping portico in Golconda Fort is a series of arches on one side, each smaller than the preceding one. So, a sound wave generated under the dome would get compressed and then bounce back amplified sufficiently to reach a considerable distance.

**5.2.2 Reflection at the boundary of a denser medium**

A longitudinal wave travels in a medium in the form of compressions and rarefactions. Suppose a compression travelling in air from left to right reaches a rigid wall. The compression exerts a force  $F$  on the rigid wall. In turn, the wall exerts an equal and opposite reaction  $R = -F$  on the air molecules. This results in a compression near the rigid wall. Thus, a compression travelling towards the rigid wall is reflected back as a compression. That is the direction of compression is reversed (Figure 5.5).

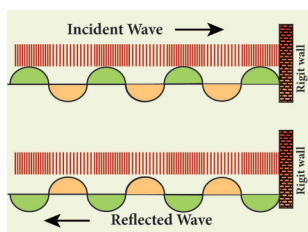

Figure 5.5 Reflection of sound at a denser medium

**5.2.3 Reflection at the boundary of a rarer medium**

Consider a wave travelling in a solid medium striking on the interface between the solid and the air. The compression exerts a force  $F$  on the surface of the rarer medium. As a rarer medium has smaller resistance for any deformation, the surface of



separation is pushed backwards (Figure 5.6). As the particles of the rarer medium are free to move, a rarefaction is produced at the interface. Thus, a compression is reflected as a rarefaction and a rarefaction travels from right to left.

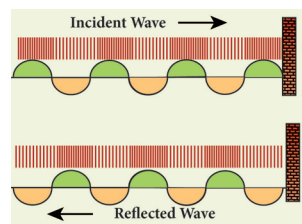

5.6 Reflection of sound at a rarer medium

**More to know:**

What is meant by rarer and denser medium? The medium in which the velocity of sound increases compared to other medium is called rarer medium. (Water is rarer compared to air for sound). The medium in which the velocity of sound decreases compared to other medium is called denser medium. (Air is denser compared to water for sound)

**5.2.4 Reflection of sound in plane and curved surfaces**

When sound waves are reflected from a plane surface, the reflected waves travel in a direction, according to the law of reflection. The intensity of the reflected wave is neither decreased nor increased. But, when the sound waves are reflected from the curved surfaces, the intensity of the reflected waves is changed. When reflected from a convex surface, the reflected waves are diverged out and the intensity is decreased. When sound is reflected from a concave surface, the reflected waves are converged and focused at a point. So the intensity of reflected waves is concentrated at a point. Parabolic surfaces are used when it is required to focus the sound at a particular point. Hence, many halls are designed with parabolic reflecting surfaces. In elliptical surfaces, sound from one focus will always be reflected to the other focus, no matter where it strikes the wall.

This principle is used in designing whispering halls. In a whispering hall, the speech of a person standing in one focus can be heard clearly by a listener standing at the other focus.

**DO YOU KNOW?** **Whispering Gallery**  
 One of the famous whispering galleries is in St. Paul's cathedral church in London. It is built with elliptically shaped walls. When a person is talking at one focus, his voice can be heard distinctly at the other focus. It is due to the multiple reflections of sound waves from the curved walls.

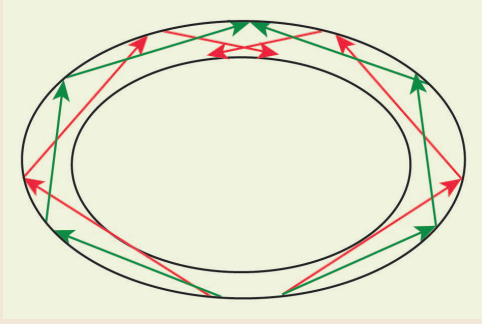

least 0.1 s. Thus, the minimum time gap between the original sound and an echo must be 0.1 s.

- The above criterion can be satisfied only when the distance between the source of sound and the reflecting surface would satisfy the following equation:

$$\text{Velocity} = \frac{\text{distance travelled by sound}}{\text{time taken}}$$

$$v = \frac{2d}{t}$$

$$d = \frac{vt}{2}$$

Since,  $t = 0.1$  second, then  $d = \frac{v \times 0.1}{2} = \frac{v}{20}$

Thus the minimum distance required to hear an echo is  $1/20^{\text{th}}$  part of the magnitude of the velocity of sound in air. If you consider the velocity of sound as  $344 \text{ ms}^{-1}$ , the minimum distance required to hear an echo is 17.2 m.

### 5.3 ECHOES

An echo is the sound reproduced due to the reflection of the original sound from various rigid surfaces such as walls, ceilings, surfaces of mountains, etc.

If you shout or clap near a mountain or near a reflecting surface, like a building you can hear the same sound again. The sound, which you hear is called an echo. It is due to the reflection of sound. One does not experience any echo sound in a small room. This does not mean that sound is not reflected in a small room. This is because smaller rooms do not satisfy the basic conditions for hearing an echo.

#### 5.3.1 Conditions necessary for hearing echo

- The persistence of hearing for human ears is 0.1 second. This means that you can hear two sound waves clearly, if the time interval between the two sounds is at

#### 5.3.2 Applications of echo

- Some animals communicate with each other over long distances and also locate objects by sending the sound signals and receiving the echo as reflected from the targets.
- The principle of echo is used in obstetric ultrasonography, which is used to create real-time visual images of the developing embryo or fetus in the mother's uterus. This is a safe testing tool, as it does not use any harmful radiations.
- Echo is used to determine the velocity of sound waves in any medium.

#### 5.3.3 Measuring velocity of sound by echo method

##### Apparatus required:

A source of sound pulses, a measuring tape, a sound receiver, and a stop watch.



**Procedure:**

1. Measure the distance 'd' between the source of sound pulse and the reflecting surface using the measuring tape.
2. The receiver is also placed adjacent to the source. A sound pulse is emitted by the source.
3. The stopwatch is used to note the time interval between the instant at which the sound pulse is sent and the instant at which the echo is received by the receiver. Note the time interval as 't'.
4. Repeat the experiment for three or four times. The average time taken for the given number of pulses is calculated.

**Calculation of speed of sound:**

The sound pulse emitted by the source travels a total distance of 2d while travelling from the source to the wall and then back to the receiver. The time taken for this has been observed to be 't'. Hence, the speed of sound wave is given by:

$$\text{Speed of sound} = \frac{\text{distance travelled}}{\text{time taken}} = \frac{2d}{t}$$

**5.4 APPLICATIONS REFLECTION OF SOUND**

**5.4.1 Sound board**

These are basically curved surfaces (concave), which are used in auditoria and halls to improve the quality of sound. This board is placed such that the speaker is at the focus of the concave surface. The sound of the speaker is reflected towards the audience thus improving the quality of sound heard by the audience.

**5.4.2 Ear trumpet**

Ear trumpet is a hearing aid, which is useful by people who have difficulty in hearing. In this device, one end is wide and the other end is narrow. The sound from the sources fall into the wide end and are reflected by its walls into the narrow part of the device. This helps in concentrating the sound and the sound enters the ear drum with more intensity. This enables a person to hear the sound better.

**5.4.3 Mega phone**

A megaphone is a horn-shaped device used to address a small gathering of people. Its one end is wide and the other end is narrow. When a person speaks at the narrow end, the sound of his speech is concentrated by the multiple reflections from the walls of the tube. Thus, his voice can be heard loudly over a long distance.

**5.5 DOPPLER EFFECT**

The whistle of a fast moving train appears to increase in pitch as it approaches a stationary listener and it appears to decrease as the train moves away from the listener. This apparent change in frequency was first observed and explained by Christian Doppler (1803-1853), an Austrian Mathematician and Physicist. He observed that the frequency of the sound as received by a listener is different from the original frequency produced by the source whenever there is a relative motion between the source and the listener. This is known as Doppler effect This relative motion could be due to various possibilities as follows:

- (i) The listener moves towards or away from a stationary source
- (ii) The source moves towards or away from a stationary listener

- (iii) Both source and listener move towards or away from one other
- (iv) The medium moves when both source and listener are at rest

**DEFINITION**

When ever there is a relative motion between a source and a listener, the frequency of the sound heard by the listener is different from the original frequency of sound emitted by the source. This is known as “Doppler effect”.

For simplicity of calculation, it is assumed that the medium is at rest. That is the velocity of the medium is zero.

Let S and L be the source and the listener moving with velocities  $v_s$  and  $v_L$  respectively. Consider the case of source and listener moving towards each other (Figure 5.7). As the distance between them decreases, the apparent

frequency will be more than the actual source frequency.

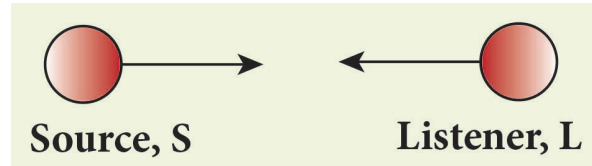

Figure 5.7 Source and listener moving towards each other

Let  $n$  and  $n'$  be the frequency of the sound produced by the source and the sound observed by the listener respectively. Then, the expression for the apparent frequency  $n'$  is

$$n' = \left( \frac{v + v_L}{v - v_s} \right) n$$

Here,  $v$  is the velocity of sound waves in the given medium. Let us consider different possibilities of motions of the source and the listener. In all such cases, the expression for the apparent frequency is given in table 5.2.

Table 5.2 Expression for apparent frequency due to Doppler effect

Case No.	Position of source and listener	Note	Expression for apparent frequency
1	<ul style="list-style-type: none"> <li>❖ Both source and listener move</li> <li>❖ They move towards each other</li> </ul>	<ul style="list-style-type: none"> <li>a) Distance between source and listener decreases.</li> <li>b) Apparent frequency is more than actual frequency.</li> </ul>	$n' = \left( \frac{v + v_L}{v - v_s} \right) n$
2	<ul style="list-style-type: none"> <li>❖ Both source and listener move</li> <li>❖ They move away from each other</li> </ul>	<ul style="list-style-type: none"> <li>a) Distance between source and listener increases.</li> <li>b) Apparent frequency is less than actual frequency.</li> <li>c) <math>v_s</math> and <math>v_L</math> become opposite to that in case-1.</li> </ul>	$n' = \left( \frac{v - v_L}{v + v_s} \right) n$
3	<ul style="list-style-type: none"> <li>❖ Both source and listener move</li> <li>❖ They move one behind the other</li> <li>❖ Source follows the listener</li> </ul>	<ul style="list-style-type: none"> <li>a) Apparent frequency depends on the velocities of the source and the listener.</li> <li>b) <math>v_s</math> becomes opposite to that in case-2.</li> </ul>	$n' = \left( \frac{v - v_L}{v - v_s} \right) n$

4	<ul style="list-style-type: none"> <li>❖ Both source and listener move</li> <li>❖ They move one behind the other</li> <li>❖ Listener follows the source</li> </ul>	<ul style="list-style-type: none"> <li>a) Apparent frequency depends on the velocities of the source and the listener.</li> <li>b) <math>v_s</math> and <math>v_L</math> become opposite to that in case-3.</li> </ul>	$n' = \left( \frac{v + v_L}{v + v_s} \right) n$
5	<ul style="list-style-type: none"> <li>❖ Source at rest</li> <li>❖ Listener moves towards the source</li> </ul>	<ul style="list-style-type: none"> <li>a) Distance between source and listener decreases.</li> <li>b) Apparent frequency is more than actual frequency.</li> <li>c) <math>v_s = 0</math> in case-1.</li> </ul>	$n' = \left( \frac{v + v_L}{v} \right) n$
6	<ul style="list-style-type: none"> <li>❖ Source at rest</li> <li>❖ Listener moves away from the source</li> </ul>	<ul style="list-style-type: none"> <li>a) Distance between source and listener increases.</li> <li>b) Apparent frequency is less than actual frequency.</li> <li>c) <math>v_s = 0</math> in case-2.</li> </ul>	$n' = \left( \frac{v - v_L}{v} \right) n$
7	<ul style="list-style-type: none"> <li>❖ Listener at rest</li> <li>❖ Source moves towards the listener</li> </ul>	<ul style="list-style-type: none"> <li>a) Distance between source and listener decreases.</li> <li>b) Apparent frequency is more than actual frequency.</li> <li>c) <math>v_L = 0</math> in case-1.</li> </ul>	$n' = \left( \frac{v}{v - v_s} \right) n$
8	<ul style="list-style-type: none"> <li>❖ Listener at rest</li> <li>❖ Source moves away from the listener</li> </ul>	<ul style="list-style-type: none"> <li>a) Distance between source and listener increases.</li> <li>b) Apparent frequency is less than actual frequency.</li> <li>c) <math>v_L = 0</math> in case-2.</li> </ul>	$n' = \left( \frac{v}{v + v_s} \right) n$

Suppose the medium (say wind) is moving with a velocity  $W$  in the direction of the propagation of sound. For this case, the velocity of sound, ' $v$ ' should be replaced with  $(v + W)$ . If the medium moves in a direction opposite to the propagation of sound, then ' $v$ ' should be replaced with  $(v - W)$ .

### Solved problems

1. A source producing a sound of frequency 90 Hz is approaching a stationary listener with a speed equal to  $(1/10)$  of the speed of sound. What will be the frequency heard by the listener?

**Solution:** When the source is moving towards the stationary listener, the expression for apparent frequency is

$$\begin{aligned}
 n' &= \left( \frac{v}{v - v_s} \right) n \\
 &= \left( \frac{v}{v - \left( \frac{1}{10} \right) v} \right) n = \left( \frac{10}{9} \right) n \\
 &= \left( \frac{10}{9} \right) \times 90 = 100 \text{ Hz}
 \end{aligned}$$

2. A source producing a sound of frequency 500 Hz is moving towards a listener with a velocity of  $30 \text{ ms}^{-1}$ . The speed of the sound is  $330 \text{ ms}^{-1}$ . What will be the frequency heard by listener?

**Solution:** When the source is moving towards the stationary listener, the expression for apparent frequency is

$$n' = \left( \frac{v}{v - v_s} \right) n$$

$$n' = \left( \frac{330}{330 - 30} \right) \times 500$$

$$= 550 \text{ Hz}$$

3. A source of sound is moving with a velocity of  $50 \text{ ms}^{-1}$  towards a stationary listener. The listener measures the frequency of the source as 1000 Hz. what will be the apparent frequency of the source when it is moving away from the listener after crossing him? (velocity of sound in the medium is  $330 \text{ m s}^{-1}$ )

**Solution:** When the source is moving towards the stationary listener, the expression for apparent frequency is

$$n' = \left( \frac{v}{v - v_s} \right) n$$

$$1000 = \left( \frac{330}{330 - 50} \right) n$$

$$n = \left( \frac{1000 \times 280}{330} \right)$$

$$n = 848.48 \text{ Hz.}$$

The actual frequency of the sound is 848.48 Hz. When the source is moving away from the stationary listener, the expression for apparent frequency is

$$n' = \left( \frac{v}{v + v_s} \right) n$$

$$= \left( \frac{330}{330 + 50} \right) \times 848.48$$

$$= 736.84 \text{ Hz}$$

4. A source and listener are both moving towards each other with a speed  $v/10$  where  $v$  is the speed of sound. If the frequency of the note emitted by the source is  $f$ , what will be the frequency heard by the listener?

**Solution:** When source and listener are both moving towards each other, the apparent frequency is

$$n' = \left( \frac{v + v_l}{v - v_s} \right) .n$$

$$n' = \left( \frac{v + \frac{v}{10}}{v - \frac{v}{10}} \right) .n$$

$$n' = \frac{11}{9} .f$$

$$= 1.22 f$$

5. At what speed should a source of sound move away from a stationary observer so that observer finds the apparent frequency equal to half of the original frequency?

**Solution:** When the source is moving away from the stationary listener, the expression for the apparent frequency is

$$n' = \left( \frac{v}{v + v_s} \right) .n$$

$$\frac{n}{2} = \left( \frac{v}{v + v_s} \right) .n$$

$$V_s = V$$

### 5.5.1 Conditions for no Doppler effect

Under the following circumstances, there will be no Doppler effect and the apparent frequency as heard by the listener will be the same as the source frequency.

- (i) When source (S) and listener (L) both are at rest.
- (ii) When S and L move in such a way that distance between them remains constant.
- (iii) When source S and L are moving in mutually perpendicular directions.
- (iv) If the source is situated at the center of the circle along which the listener is moving.

### 5.5.2 Applications of Doppler effect

#### (a) To measure the speed of an automobile

An electromagnetic wave is emitted by a source attached to a police car. The wave is reflected by a moving vehicle, which acts as a moving source. There is a shift in the frequency of the reflected wave. From the frequency shift, the speed of the car can be determined. This helps to track the over speeding vehicles.

#### (b) Tracking a satellite

The frequency of radio waves emitted by a satellite decreases as the satellite passes away from the Earth. By measuring the change in the frequency of the radio waves, the location of the satellites is studied.

#### (c) RADAR (Radio Detection And Ranging)

In RADAR, radio waves are sent, and the reflected waves are detected by the receiver

of the RADAR station. From the frequency change, the speed and location of the aeroplanes and aircrafts are tracked.

#### (d) SONAR

In SONAR, by measuring the change in the frequency between the sent signal and received signal, the speed of marine animals and submarines can be determined.

#### Points to Remember

- ❖ Wave velocity is the velocity with which the wave travels through the medium.
- ❖ Velocity of a sound wave is maximum in solids because they are more elastic in nature than liquids and gases. Since gases are least elastic in nature.
- ❖ Infrasonic waves are sound wave with a frequency below 20 Hz. A human ear cannot hear these waves.
- ❖ Ultrasonic waves are sound waves with frequency greater than 20 kHz, A human ear cannot detect these waves.
- ❖ Reflection of sound waves obey the laws of reflection.
- ❖ when a compression hits the boundary of a rarer medium, it is reflected as a rarefaction.
- ❖ An echo is the sound reproduced due to the reflection of the original sound wave.
- ❖ The minimum distance between the source and the reflecting surface should be 17.2 m to hear an echo clearly.
- ❖ “The apparent frequency” is the frequency of the sound as heard by the listener.



## TEXTBOOK EVALUATION



### I. Choose the correct answer

- When a sound wave travels through air, the air particles
  - vibrate along the direction of the wave motion
  - vibrate but not in any fixed direction
  - vibrate perpendicular to the direction of the wave motion
  - do not vibrate
- Velocity of sound in a gaseous medium is  $330 \text{ ms}^{-1}$ . If the pressure is increased by 4 times without causing a change in the temperature, the velocity of sound in the gas is
 

a) $330 \text{ ms}^{-1}$	b) $660 \text{ ms}^{-1}$
c) $156 \text{ ms}^{-1}$	d) $990 \text{ ms}^{-1}$
- The frequency, which is audible to the human ear is
 

a) 50 kHz	b) 20 kHz
c) 15000 kHz	d) 10000 kHz
- The velocity of sound in air at a particular temperature is  $330 \text{ ms}^{-1}$ . What will be its value when temperature is doubled and the pressure is halved?
 

a) $330 \text{ ms}^{-1}$	b) $165 \text{ ms}^{-1}$
c) $330 \times \sqrt{2} \text{ ms}^{-1}$	d) $320 / \sqrt{2} \text{ ms}^{-1}$
- If a sound wave travels with a frequency of  $1.25 \times 10^4 \text{ Hz}$  at  $344 \text{ ms}^{-1}$ , the wavelength will be
 

a) 27.52 m	b) 275.2 m
c) 0.02752 m	d) 2.752 m
- The sound waves are reflected from an obstacle into the same medium from which they were incident. Which of the following changes?
 

a) speed	b) frequency
c) wavelength	d) none of these
- Velocity of sound in the atmosphere of a planet is  $500 \text{ ms}^{-1}$ . The minimum distance between the sources of sound and the obstacle to hear the echo, should be
 

a) 17 m	b) 20 m	c) 25 m	d) 50 m
---------	---------	---------	---------

### II. Fill up the blanks

- Rapid back and forth motion of a particle about its mean position is called \_\_\_\_\_
- If the energy in a longitudinal wave travels from south to north, the particles of the medium would be vibrating in \_\_\_\_\_
- A whistle giving out a sound of frequency 450 Hz, approaches a stationary observer at a speed of  $33 \text{ ms}^{-1}$ . The frequency heard by the observer is (speed of sound =  $330 \text{ ms}^{-1}$ ) \_\_\_\_\_.
- A source of sound is travelling with a velocity 40 km/h towards an observer and emits a sound of frequency 2000 Hz. If the velocity of sound is 1220 km/h, then the apparent frequency heard by the observer is \_\_\_\_\_.

### III. True or false:- (If false give the reason)

- Sound can travel through solids, gases, liquids and even vacuum.
- Waves created by Earth Quake are Infrasonic.
- The velocity of sound is independent of temperature.
- The Velocity of sound is high in gases than liquids.

### IV. Match the following

- |                         |                       |
|-------------------------|-----------------------|
| 1. Infrasonic           | - (a) Compressions    |
| 2. Echo                 | - (b) 22 kHz          |
| 3. Ultrasonic           | - (c) 10 Hz           |
| 4. High pressure region | - (d) Ultrasonography |

**V. Assertion and Reason Questions**

Mark the correct choice as

- a. If both the assertion and the reason are true and the reason is the correct explanation of the assertion.
- b. If both the assertion and the reason are true but the reason is not the correct explanation of the assertion.
- c. Assertion is true, but the reason is false.
- d. Assertion is false, but the reason is true.

1) **Assertion:** The change in air pressure affects the speed of sound.

**Reason:** The speed of sound in a gas is proportional to the square of the pressure

2) **Assertion:** Sound travels faster in solids than in gases.

**Reason:** Solid possesses a greater density than that of gases.

**VI. Answer very briefly**

1. What is a longitudinal wave?
2. What is the audible range of frequency?
3. What is the minimum distance needed for an echo?
4. What will be the frequency sound having 0.20 m as its wavelength, when it travels with a speed of 331 ms<sup>-1</sup>?
5. Name three animals, which can hear ultrasonic vibrations.

**VII. Answer briefly**

1. Why does sound travel faster on a rainy day than on a dry day?
2. Why does an empty vessel produce more sound than a filled one?
3. Air temperature in the Rajasthan desert can reach 46°C. What is the velocity of sound in air at that temperature? ( $V_0 = 331 \text{ ms}^{-1}$ )

4. Explain why, the ceilings of concert halls are curved.
5. Mention two cases in which there is no Doppler effect in sound?

**VIII. Problem Corner**

1. A sound wave has a frequency of 200 Hz and a speed of 400 ms<sup>-1</sup> in a medium. Find the wavelength of the sound wave.
2. The thunder of cloud is heard 9.8 seconds later than the flash of lightning. If the speed of sound in air is 330 ms<sup>-1</sup>, what will be the height of the cloud?
3. A person who is sitting at a distance of 400 m from a source of sound is listening to a sound of 600 Hz. Find the time period between successive compressions from the source?
4. An ultrasonic wave is sent from a ship towards the bottom of the sea. It is found that the time interval between the transmission and reception of the wave is 1.6 seconds. What is the depth of the sea, if the velocity of sound in the seawater is 1400 ms<sup>-1</sup>?
5. A man is standing between two vertical walls 680 m apart. He claps his hands and hears two distinct echoes after 0.9 seconds and 1.1 second respectively. What is the speed of sound in the air?
6. Two observers are stationed in two boats 4.5 km apart. A sound signal sent by one, under water, reaches the other after 3 seconds. What is the speed of sound in the water?
7. A strong sound signal is sent from a ship towards the bottom of the sea. It is received back after 1s. What is the depth of sea given that the speed of sound in water 1450 ms<sup>-1</sup>?

**IX. Answer in Detail**

1. What are the factors that affect the speed of sound in gases?
2. What is mean by reflection of sound? Explain:
  - a) reflection at the boundary of a rarer medium
  - b) reflection at the boundary of a denser medium
  - c) Reflection at curved surfaces
3.
  - a) What do you understand by the term 'ultrasonic vibration'?
  - b) State three uses of ultrasonic vibrations.
  - c) Name three animals which can hear ultrasonic vibrations.
4. What is an echo?
  - a) State two conditions necessary for hearing an echo.
  - b) What are the medical applications of echo?
  - c) How can you calculate the speed of sound using echo?

**X. HOT Questions**

1. Suppose that a sound wave and a light wave have the same frequency, then which one has a longer wavelength?
  - a) Sound
  - b) Light
  - c) both a and b
  - d) data not sufficient
2. When sound is reflected from a distant object, an echo is produced. Let the distance between the reflecting surface and the source of sound remain the same. Do you hear an echo sound on a hotter day? Justify your answer.

**REFERENCE BOOKS**

1. Fundamental Physics by K.L. Gomber and K.L. Gogia
2. Fundamentals of sound and vibration by Franky Fahy and David Thombson
3. The theory of sound by Rayleigh and John William Strutt

**INTERNET RESOURCE**

1. <http://people.bath.ac.uk/ensmjc/Notes/acoustics.pdf>



## Concept Map

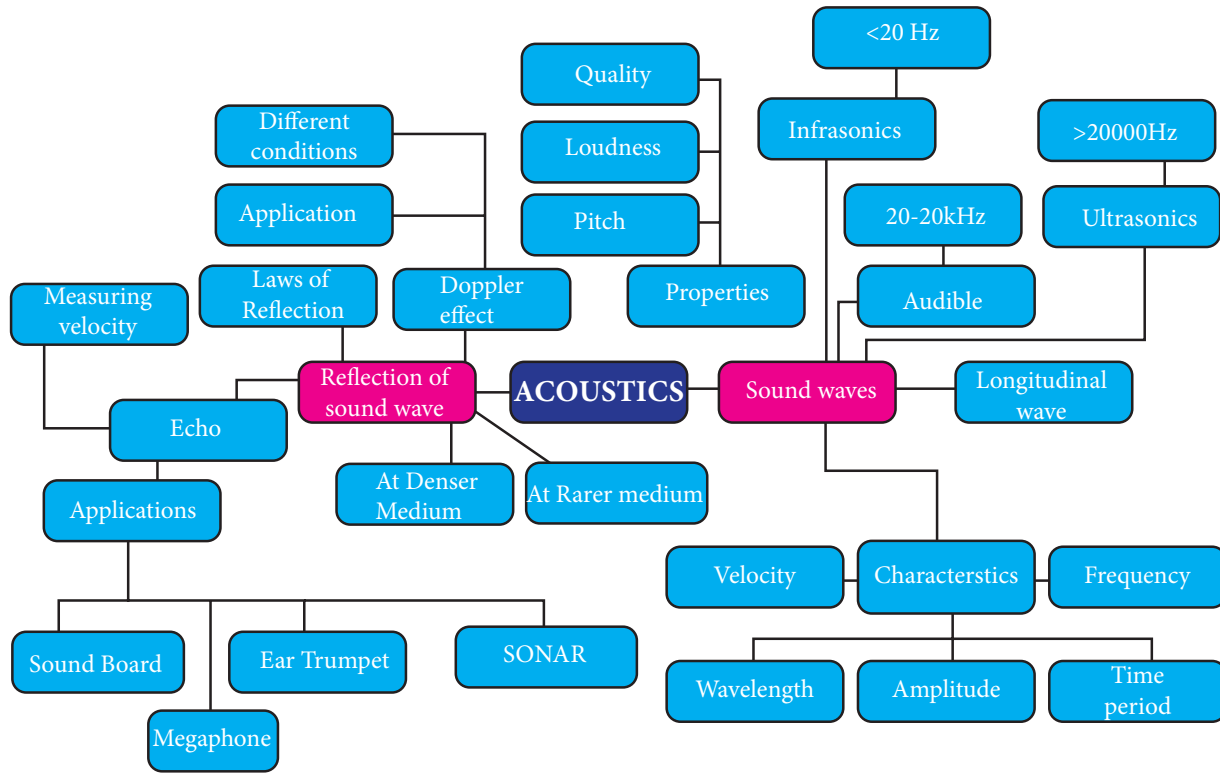

### ICT CORNER

## Doppler effect

In this activity you will be able to learn how the observed frequencies of a sound changes with the velocities of the source and the observer (Doppler effect).

#### Steps

- Open the browser and type “vlab.amrita.edu” in the address bar. Click ‘Physical Sciences’ and then click ‘Harmonic Motion and Waves Virtual Lab’. Click ‘Doppler Effect’ and Go to “simulator” tab to do the experiment. sign up one time with your e-mail
- Select medium of travel, detector direction and source direction by clicking the drop down menu.
- Change relative motion between source and observer by adjusting the velocity of the source and observer using the slider.
- Discuss how apparent frequency is changes with respect to actual frequency by changing position of source and listener. Also try for different source frequencies.

#### Link

<http://vlab.amrita.edu/?sub=1&brch=201&sim=368&cnt=4>



B375\_10\_SCIENCE\_EM

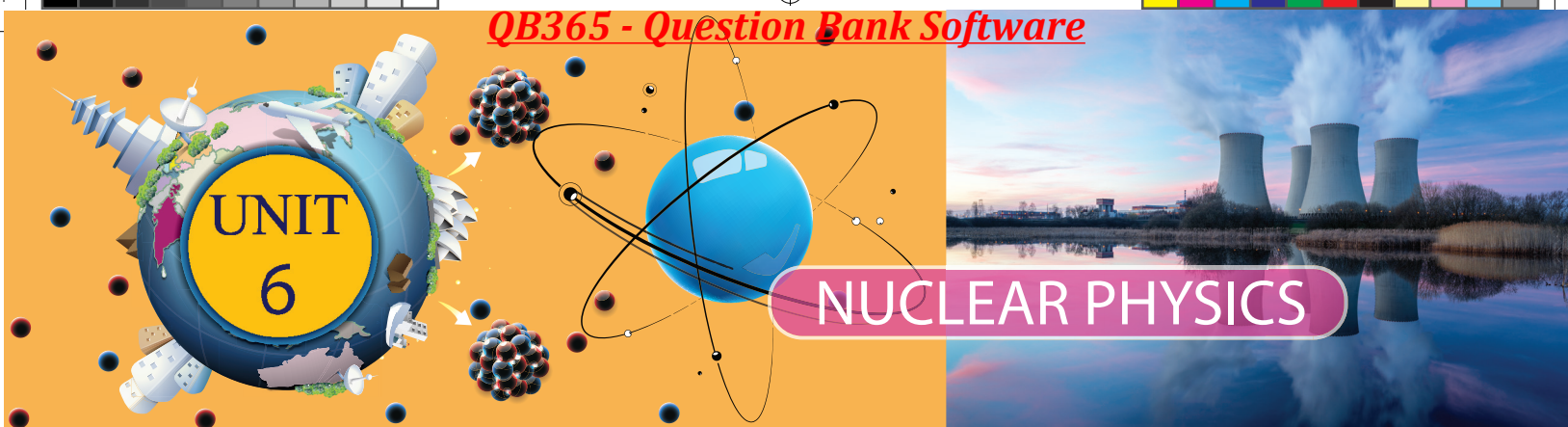

## Learning Objectives



After learning this unit, students will be able to

- ◆ Define radio activity.
- ◆ Distinguish between natural and artificial radio activity.
- ◆ Relate the properties of alpha, beta and gamma rays.
- ◆ State Soddy and Fajan's displacement law of nuclear disintegration.
- ◆ Understand the concept of nuclear fission and nuclear fusion.
- ◆ Identify fissionable materials.
- ◆ Analyze controlled and uncontrolled chain reactions.
- ◆ Explain the principle of atom bomb and hydrogen bomb.
- ◆ List the uses of radio activity.
- ◆ Understand the components of a nuclear reactor.
- ◆ Identify the precautionary measures while handling a radioactive material.

## INTRODUCTION

Humans are very much interested in knowing about atoms. Things around us are made up of atoms. A Greek Philosopher 'Democritus' in 400 BC(BCE) believed that matter is made up of tiny indestructible units called atoms. Later, in 1803, John Dalton considered that elements consist of atoms, which are identical in nature. J J Thomson discovered cathode rays, known as electrons, experimentally and

Goldstein discovered positive rays, which were named as protons by Rutherford. In 1932, James Chadwick discovered the chargeless particles called neutrons. Presently, a large number of elementary particles like photon, meson, positron and neutrino have been discovered. In 1911, the British scientist, Ernest **Rutherford** explained that the mass of an atom is concentrated in its central part called **Nucleus**. You have already learnt about the atomic structure in the earlier classes.

## 6.1 RADIOACTIVITY

### 6.1.1 Discovery of radioactivity

In 1896, French physicist **Henri Becquerel** finished his research for the week and stored a certain amount of uranium compound away in a drawer for the week end. By chance, an unexposed photographic plate was also stored in the same drawer. After a week he returned and noticed that the film had been exposed to some radiation. He discovered that he could reproduce the effect whenever he placed uranium near a photographic film. Apparently, uranium radiated something that could affect a photographic plate. This phenomenon was called as **Radioactivity**. Uranium was identified to be a radioactive element.

Two years later, the Polish physicist **Marie Curie** and her husband **Pierre Curie** detected radioactivity in 'Pitchblende', a tiny black substance. They were not surprised at the radioactivity of pitchblende, which is known as an ore of uranium. Later, they discovered that the radiation was more intense from pure uranium. Also, it was found that the pitchblende had less concentration of uranium. They concluded that **some other substance** was present in pitchblende. After separating this new substance, they discovered that it had unknown chemical properties and it also emitted radiations spontaneously like uranium. They named this new substance as '**Radium**'. The radioactive elements emit harmful radioactive radiations like alpha rays or beta rays or gamma rays.

### 6.1.2 Definition of radioactivity

The nucleus of some elements is unstable. Such nuclei undergo nuclear decay and get converted into more stable nuclei. During this nuclear reaction, these nuclei emit certain harmful radiations and elementary particles. The phenomenon of nuclear decay of certain elements

with the emission of radiations like alpha, beta, and gamma rays is called 'radioactivity' and the elements, which undergo this phenomenon are called 'radioactive elements'.

### 6.1.3 Natural Radioactivity

The elements such as uranium and radium undergo radioactivity and emit the radiations on their own without any human intervention. This phenomenon of spontaneous emission of radiation from certain elements on their own is called 'natural radioactivity'.

The elements whose atomic number is more than 82 undergo spontaneous radioactivity. Eg: uranium, radium, etc. There are only two elements, which have been identified as radioactive substances with atomic number less than 82. They are technetium (Tc) with atomic number 43 and promethium (Pm) with atomic number 61.

DO  
YOU  
KNOW?

There have been 29 radioactive substances discovered so far. Most of them are rare earth metals and transition metals.

### 6.1.4 Artificial Radioactivity (or) Induced Radioactivity

The phenomenon by which even light elements are made radioactive, by artificial or induced methods, is called 'artificial radioactivity' or 'man-made radioactivity'.

This kind of radioactivity was discovered by Irene Curie and F.Joliot in 1934. Artificial radioactivity is induced in certain lighter elements like boron, aluminium etc., by bombarding them with radiations such as 'alpha particles' emitted during the natural radioactivity of uranium. This also results in the emission of invisible radiations and elementary particles. During such a disintegration, the nucleus which undergoes disintegration is called 'parent nucleus' and that which is produced after the disintegration is called a 'daughter nucleus'. The particle, which

Table 6.1 Comparison between Natural and Artificial Radioactivity

S.No.	Natural radioactivity	Artificial radioactivity
1	Emission of radiation due to self-disintegration of a nucleus.	Emission of radiation due to disintegration of a nucleus through induced process.
2	Alpha, beta and gamma radiations are emitted.	Mostly elementary particles such as neutron, positron, etc. are emitted.
3	It is a spontaneous process.	It is an induced process.
4	Exhibited by elements with atomic number more than 83.	Exhibited by elements with atomic number less than 83.
5	This cannot be controlled.	This can be controlled.

is used to induce the artificial disintegration is termed as projectile and the particle which is produced after the disintegration is termed as ejected particle. When the projectile hits the parent nucleus, it is converted into an unstable nucleus, which in turn decays spontaneously emitting the daughter nucleus along with an ejected particle.

### Activity 6.1

Using the periodic table, list out the radioactive elements. Also identify the name of the groups in which they are present.

If you denote the parent and daughter nuclei as X and Y respectively, then the nuclear disintegration is represented as follows: X (P,E) Y. Here, P and E represent the projectile particle and ejected particle respectively.

#### Example:

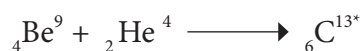

In the above nuclear reaction,  ${}_6\text{C}^{13*}$  is unstable and is radioactive. This reaction can be represented as  ${}_4\text{Be}^9 (\alpha, n) {}_6\text{C}^{12}$

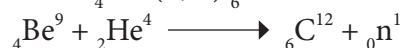

### 6.1.5 Units of Radioactivity

**Curie:** It is the traditional unit of radioactivity. It is defined as the quantity of a radioactive substance which undergoes  $3.7 \times 10^{10}$  disintegrations in one second. This is actually close to the activity of 1 g of radium 226.

1 curie =  $3.7 \times 10^{10}$  disintegrations per second.

**Rutherford (Rd):** It is another unit of radioactivity. It is defined as the quantity of a radioactive substance, which produces  $10^6$  disintegrations in one second.

1 Rd =  $10^6$  disintegrations per second.

**Becquerel (Bq) :** It is The SI unit of radioactivity is becquerel. It is defined as the quantity of one disintegration per second.

**Roentgen (R):** It is The radiation exposure of  $\gamma$  and x-rays is measured by another unit called roentgen. One roentgen is defined as the quantity of radioactive substance which produces a charge of  $2.58 \times 10^{-4}$  coulomb in 1 kg of air under standard conditions of pressure, temperature and humidity.



## 6.2 ALPHA, BETA AND GAMMA RAYS

When a radioactive nucleus undergoes radioactivity, it emits harmful radiations. These radiations are usually comprised of any of the three types of particles. They are **alpha( $\alpha$ )**, **beta ( $\beta$ )** and **gamma( $\gamma$ )** rays.



Uranium, named after the planet Uranus, was discovered by Martin Klaproth, a German chemist in a mineral called pitchblende.

### 6.2.1 Properties of Alpha, Beta and Gamma rays

These three particles possess certain similarities and dissimilarities in their properties as listed below in Table 6.2.

### 6.2.2 Radioactive displacement law

In 1913, Soddy and Fajan framed the displacement laws governing the daughter nucleus produced during an alpha and beta decay. They are stated below:

(i) When a radioactive element emits an alpha particle, a daughter nucleus is formed whose mass number is less by 4 units and the atomic number is less by 2 units, than the mass number and atomic number of the parent nucleus.

(ii) When a radioactive element emits a beta particle, a daughter nucleus is formed whose mass number is the same and the atomic number is more by 1 unit, than the atomic number of the parent nucleus.

Table 6.2 Properties of alpha, beta and gamma rays

Properties	$\alpha$ rays	$\beta$ rays	$\gamma$ rays
What are they?	Helium nucleus ( ${}_2\text{He}^4$ ) consisting of two protons and two neutrons.	They are electrons ( ${}_{-1}\text{e}^0$ ), basic elementary particle in all atoms.	They are electromagnetic waves consisting of photons.
Charge	Positively charged particles. Charge of each alpha particle = $+2e$	Negatively charged particles. Charge of each beta particle = $-e$	Neutral particles. Charge of each gamma particle = zero
Ionising power	100 time greater than $\beta$ rays and 10,000 times greater than $\gamma$ rays	Comparatively low	Very less ionization power
Penetrating power	Low penetrating power (even stopped by a thick paper)	Penetrating power is greater than that of $\alpha$ rays. They can penetrate through a thin metal foil.	They have a very high penetrating power greater than that of $\beta$ rays. They can penetrate through thick metal blocks.
Effect of electric and magnetic field	Deflected by both the fields. (in accordance with Fleming's left hand rule)	Deflected by both the fields; but the direction of deflection is opposite to that for alpha rays. (in accordance with Fleming's left hand rule)	They are not deflected by both the fields.
Speed	Their speed ranges from 1/10 to 1/20 times the speed of light.	Their speed can go up to 9/10 times the speed of light.	They travel with the speed of light.

### 6.2.3 Alpha decay

A nuclear reaction in which an unstable parent nucleus emits an alpha particle and forms a stable daughter nucleus, is called 'alpha decay'.

**E.g.:** Decay of uranium ( $U^{238}$ ) to thorium ( $Th^{234}$ ) with the emission of an alpha particle.

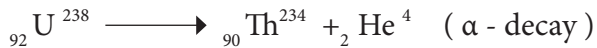

In  $\alpha$  - decay, the parent nucleus emits an  $\alpha$  particle and so it is clear that for the daughter nucleus, the mass number decreases by four and the atomic number decreases by two as illustrated in Figure 6.1

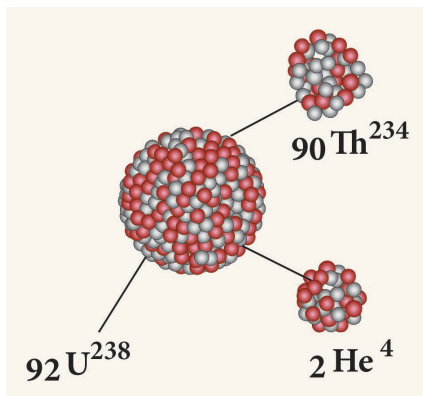
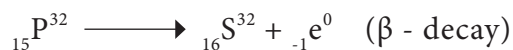

Figure 6.1 Alpha decay

### 6.2.4 Beta decay

A nuclear reaction, in which an unstable parent nucleus emits a beta particle and forms a stable daughter nucleus, is called 'beta decay'.

**E.g.:** Beta decay of phosphorous.



In  $\beta$  - decay there is no change in the mass number of the daughter nucleus but the atomic number increases by one.

**Note:** In a nuclear reaction, the element formed as the product nucleus is identified by the atomic number of the resulting nucleus and not by its mass number.

### 6.2.5 Gamma decay

In a  $\gamma$  - decay, only the energy level of the nucleus changes. The atomic number and mass number of the radioactive nucleus remain the same.

## 6.3 NUCLEAR FISSION

### 6.3.1 Definition

In 1939, German Scientist Otto Hahn and F.Strassman discovered that when a uranium nucleus is bombarded with a neutron, it breaks up into two smaller nuclei of comparable mass along with the emission of a few neutrons and energy. This process of breaking (splitting) up of a heavier nucleus into two smaller nuclei with the release of a large amount of energy and a few neutrons is called 'nuclear fission'.

**E.g.:** Nuclear fission of a uranium nucleus ( $U^{235}$ )

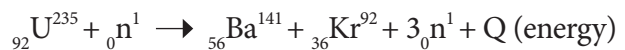

The average energy released in each fission process is about  $3.2 \times 10^{-11}$  J. Nuclear fission is pictorially represented in Figure 6.2.

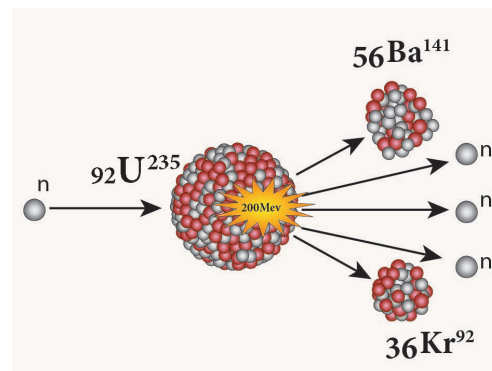

Figure 6.2 Nuclear fission

### 6.3.2 Fissionable materials

A fissionable material is a radioactive element, which undergoes fission in a sustained manner when it absorbs a neutron. It is also termed as 'fissile material'.

**E.g.:**  $U^{235}$ , plutonium ( $Pu^{239}$  and  $Pu^{241}$ )

All isotopes of uranium do not undergo nuclear fission when they absorb a neutron. For example, natural uranium consists of 99.28 % of  ${}_{92}U^{238}$  and 0.72 % of  ${}_{92}U^{235}$ . Of these two,  $U^{238}$  does not undergo fission

whereas  $U^{235}$  undergoes fission. Hence,  $U^{235}$  is a fissionable material and  $U^{238}$  is non-fissionable.

There are some radioactive elements, which can be converted into fissionable material. They are called as **fertile materials**.

**E.g.:** Uranium-238, Thorium-232, Plutonium-240.

### 6.3.3 Chain Reaction

A uranium nucleus ( $U^{235}$ ) when bombarded with a neutron undergoes fission producing three neutrons. These three neutrons in turn can cause fission in three other uranium nuclei present in the sample, thus producing nine neutrons. These nine neutrons in turn may produce twenty seven neutrons and so on. This is known as 'chain reaction'. A chain reaction is a self-propagating process in which the number of neutrons goes on multiplying rapidly almost in a geometrical progression.

Two kinds of chain reactions are possible. They are: (i) controlled chain reaction and (ii) uncontrolled chain reaction.

#### (a) Controlled chain reaction

In the controlled chain reaction the number of neutrons released is maintained to be one. This is achieved by absorbing the extra neutrons with a neutron absorber leaving only one neutron to produce further fission. Thus, the reaction is sustained in a controlled manner. The energy released due to a controlled chain reaction can be utilized for constructive purposes. Controlled chain reaction is used in a nuclear reactor to produce energy in a sustained and controlled manner.

#### (b) Uncontrolled chain reaction

In the uncontrolled chain reaction the number of neutrons multiplies indefinitely and causes fission in a large amount of the fissile

material. This results in the release of a huge amount of energy within a fraction of a second. This kind of chain reaction is used in the atom bomb to produce an explosion. Figure 6.3 represents an uncontrolled chain reaction.

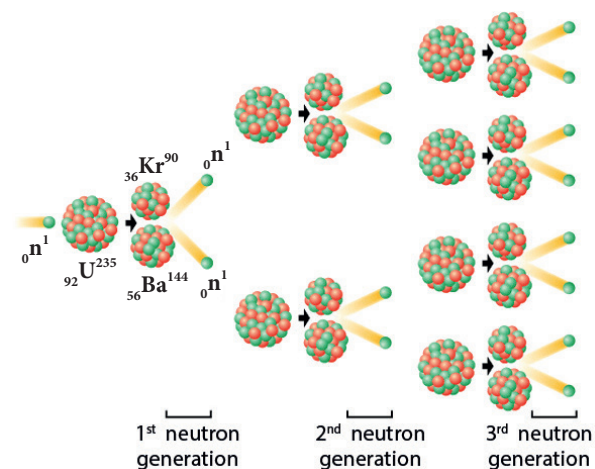

Figure 6.3 Uncontrolled chain reaction

### 6.3.4 Critical Mass

During a nuclear fission process, about 2 to 3 neutrons are released. But, all these neutrons may not be available to produce further fission. Some of them may escape from the system, which is termed as 'leakage of neutrons' and some may be absorbed by the non-fissionable materials present in the system. These two factors lead to the loss of neutrons. To sustain the chain reaction, the rate of production of neutrons due to nuclear fission must be more than the rate of its loss. This can be achieved only when the size (i.e., mass) of the fissionable material is equal to a certain optimum value. This is known as 'critical mass'.

The minimum mass of a fissile material necessary to sustain the chain reaction is called 'critical mass ( $m_c$ )'. It depends on the nature, density and the size of the fissile material.

If the mass of the fissile material is less than the critical mass, it is termed as 'subcritical'. If the mass of the fissile material is more than the critical mass, it is termed as 'supercritical'.

#### Activity 6.2

Using beads make a chain reaction model

### 6.3.5 Atom bomb

The atom bomb is based on the principle of uncontrolled chain reaction. In an uncontrolled chain reaction, the number of neutrons and the number of fission reactions multiply almost in a geometrical progression. This releases a huge amount of energy in a very small time interval and leads to an explosion.

#### Structure:

An atom bomb consists of a piece of fissile material whose mass is subcritical. This piece has a cylindrical void. It has a cylindrical fissile material which can fit into this void and its mass is also subcritical. When the bomb has to be exploded, this cylinder is injected into the void using a conventional explosive. Now, the two pieces of fissile material join to form the supercritical mass, which leads to an explosion. The structure of an atom bomb is shown in Figure 6.4

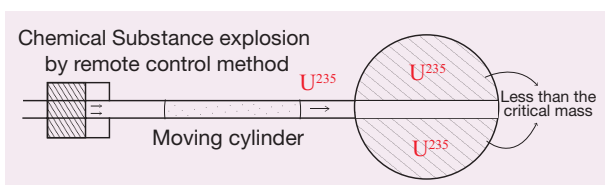

Figure 6.4 Atom bomb

During this explosion tremendous amount of energy in the form of heat, light and radiation is released. A region of very high temperature and pressure is formed in a fraction of a second along with the emission of hazardous radiation like  $\gamma$  rays, which adversely affect the living creatures. This type of atom bombs were exploded in 1945 at Hiroshima and Nagasaki in Japan during the World War II.



Electron Volt (eV) is the unit used in nuclear physics to measure the energy of small particles. It is nothing but the energy of one electron when it is accelerated using an electric potential of one volt.

$$1\text{eV} = 1.602 \times 10^{-19} \text{ joule.}$$

$$1 \text{ million electron volt} = 1 \text{ MeV} = 10^6 \text{ eV}$$

(mega electron volt)

The energy released in a nuclear fission process is about 200 MeV.

## 6.4 NUCLEAR FUSION

You have learnt that energy can be produced when a heavy nucleus is split up into two smaller nuclei. Similarly, energy can be produced when two lighter nuclei combine to form a heavier nucleus. This phenomenon is known as nuclear fusion.



### 6.4.1 Definition

The process in which two lighter nuclei combine to form a heavier nucleus is termed as 'nuclear fusion'.

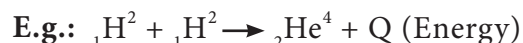

Here,  ${}_1\text{H}^2$  represents an isotope of hydrogen known as 'deuterium'. The average energy released in each fusion reaction is about  $3.84 \times 10^{-12}$  J. Figure 6.5 represents this.

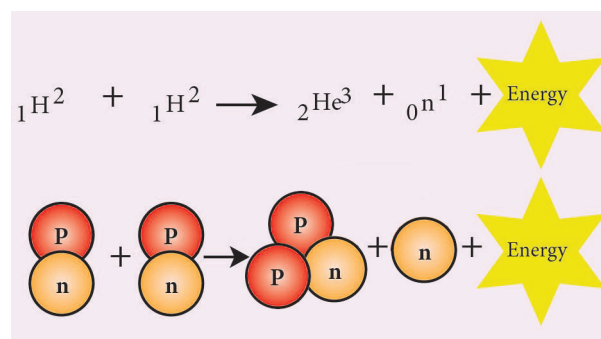

Figure 6.5 Nuclear fusion



The mass of the daughter nucleus formed during a nuclear reaction (fission and fusion) is lesser than the sum of the masses of the two parent nuclei. This difference in mass is called mass defect. This mass is converted into energy, according to the mass-energy equivalence. This concept of mass-energy equivalence was proposed by Einstein in 1905. It stated that mass can be converted into energy and vice versa. The relation between mass and energy proposed by Einstein is  $E = mc^2$  where  $c$  is the velocity of light in vacuum and is equal to  $3 \times 10^8 \text{ ms}^{-1}$ .



The nuclear bomb that was dropped in Hiroshima during World War II was called as 'Little boy'. It was a gun-type bomb which used a uranium core. The bomb, which was subsequently dropped over Nagasaki was called as 'Fat man'. It was an explosion type bomb, which used a plutonium core.

### 6.4.2 Conditions necessary for nuclear fusion

Earth's atmosphere contains a small trace of hydrogen. If nuclear fusion is a spontaneous process at normal temperature and pressure, then a number of fusion processes would happen in the atmosphere which may lead to explosions. But, we do not encounter any such explosions. Can you explain why?

The answer is that nuclear fusion can take place only under certain conditions.

Nuclear fusion is possible only at an extremely high temperature of the order of  $10^7$  to  $10^9$  K and a high pressure to push the hydrogen nuclei closer to fuse with each other. Hence, it is named as 'Thermonuclear reaction'.



Nuclear fusion is the combination of two lighter nuclei. The charge of both nuclei is positive. According to electrostatic theory, when they come closer they tend to repel each other. This repulsive force will be overcome by the kinetic energy of the nuclei at higher temperature of the order of  $10^7$  to  $10^9$  K.

### 6.4.3 Stellar Energy

The stars like our Sun emit a large amount of energy in the form of light and heat. This energy is termed as the stellar energy. Where does this high energy come from? All stars contain a large amount of hydrogen. The surface temperature of the stars is very high which is sufficient to induce fusion of the hydrogen nuclei.

Fusion reaction that takes place in the cores of the Sun and other stars results in an enormous amount of energy, which is called as 'stellar energy'. Thus, nuclear fusion or thermonuclear reaction is the source of light and heat energy in the Sun and other stars.

### 6.4.4 Hydrogen Bomb

Hydrogen bomb is based on the principle of nuclear fusion. A hydrogen bomb is always designed to have an inbuilt atom bomb which creates the high temperature and pressure required for fusion when it explodes. Then, fusion takes place in the hydrogen core and leads to the release of a very large amount of energy in an uncontrolled manner. The energy released in a hydrogen bomb (or fusion bomb) is much higher than that released in an atom bomb (or fission bomb).

**Table 6.3 Features of Nuclear fission and nuclear fusion**

S.No.	NUCLEAR FISSION	NUCLEAR FUSION
1	The process of breaking up (splitting) of a heavy nucleus into two smaller nuclei is called ' <b>nuclear fission</b> '.	Nuclear fusion is the combination of two lighter nuclei to form a heavier nucleus.
2	Can be performed at room temperature.	Extremely high temperature and pressure is needed.
3	Alpha, beta and gamma radiations are emitted.	Alpha rays, positrons, and neutrinos are emitted.
4	Fission leads to emission of gamma radiation. This triggers the mutation in the human gene and causes genetic transform diseases.	Only light and heat energy is emitted.

**DO YOU KNOW?** Sun fuses about 620 million metric tons of hydrogen each second and radiates about  $3.8 \times 10^{26}$  joule of energy per second. When this energy is radiated towards the Earth, it decreases in its intensity. When it reaches the Earth its value is about 1.4 kilo joule per unit area in unit time.

prevent the wastage of agricultural products. Certain perishable cereals exposed to radiations remain fresh beyond their normal life, enhancing the storage time. Very small doses of radiation prevent sprouting and spoilage of onions, potatoes and gram.

## 6.5 USES OF RADIOACTIVITY

Many radio isotopes can be obtained from radioactivity. These radio isotopes have found wide variety of applications in the fields of medicine, agriculture, industry and archeological research.



### 6.5.1 Agriculture

The radio isotope of phosphorous (P-32) helps to increase the productivity of crops. The radiations from the radio isotopes can be used to kill the insects and parasites and

### 6.5.2 Medicine

Medical applications of radio isotopes can be divided into two parts:

- i) Diagnosis ii) Therapy

Radio isotopes are used as tracers to diagnose the nature of circulatory disorders of blood, defects of bone metabolism, to locate tumors, etc. Some of the radio isotopes which are used as tracers are: hydrogen, carbon, nitrogen, sulphur, etc.

- Radio sodium ( $\text{Na}^{24}$ ) is used for the effective functioning of heart.
- Radio – Iodine ( $\text{I}^{131}$ ) is used to cure goiter.
- Radio-iron is ( $\text{Fe}^{59}$ ) is used to diagnose anaemia and also to provide treatment for the same.
- Radio phosphorous ( $\text{P}^{32}$ ) is used in the treatment of skin diseases.

- Radio cobalt ( $\text{Co}^{60}$ ) and radio-gold ( $\text{Au}^{198}$ ) are used in the treatment of skin cancer.
- Radiations are used to sterilize the surgical devices as they can kill the germs and microbes.

### 6.5.3 Industries

In industries, radioactive isotopes are used as tracers to detect any manufacturing defects such as cracks and leaks. Packaging faults can also be identified through radio activity. Gauges, which have radioactive sources are used in many industries to check the level of gases, liquids and solids.

- An isotope of californium ( $\text{Cf}^{252}$ ) is used in the airlines to detect the explosives in the luggage.
- An isotope of Americium ( $\text{Am}^{241}$ ) is used in many industries as a smoke detector.

### 6.5.4. Archeological research

Using the technique of radio carbon dating, the age of the Earth, fossils, old paintings and monuments can be determined. In radio carbon dating, the existing amount of radio carbon is determined and this gives an estimate about the age of these things.

## 6.6 SAFETY MEASURES

In day to day life, you do receive some natural radiation from the Sun. The radioactive elements present in the soil and rocks, the house hold appliances like television, microwave ovens, cell phones and the X-rays used in hospitals. These radiations do not produce any severe effects as they are very low in intensity.

The second source of radiation exposure is man-made. These are due to nuclear reactors and during the testing of the nuclear devices in the atmosphere or in the ground.

Improper and careless handling of radioactive materials release harmful radiations in our environment. These radiations are very harmful to the human body. A person who is exposed to radiations very closely or for a longer duration, is at a greater health risk and can be affected genetically.



How old is our mother Earth? Any guess?? It is nearly  $4.54 \times 10^9$  years (around 45 Crore 40 lakh years). Wow!!

### 6.6.1 Permitted range

The International Commission on Radiological Protection (ICRP) has recommended certain maximum permissible exposure limits to radiation that is believed to be safe without producing any appreciable injury to a person. Safe limit of overall exposure to radiation is given as 20 milli sievert per year. In terms of roentgen, the safe limit of receiving the radiation is about 100 mR per week. If the exposure is 100 R, it may cause fatal diseases like leukemia (death of red blood corpuscle in the blood) or cancer. When the body is exposed to about 600 R, it leads to death.



\*Dosimeter is a device used to detect the levels of exposure to an ionizing radiation. It is frequently used in the environments where exposure to radiation may occur such as nuclear power plants and medical imaging facilities. Pocket dosimeter is used to provide the wearer with an immediate reading of his/her exposure to X-rays and  $\gamma$  rays.

### 6.6.2 Preventive measures

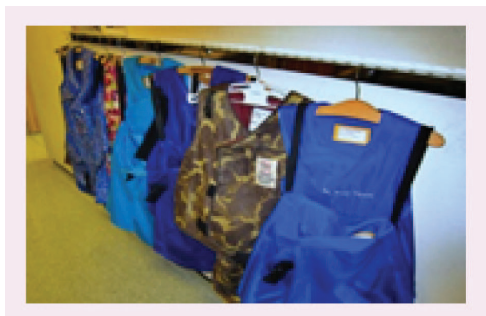

Figure 6.6 Lead coated aprons model.

- Radioactive materials should be kept in a thick walled lead container.
- Lead coated aprons and lead gloves should be used while working with hazardous radioactive materials.
- You should avoid eating while handling radioactive materials.
- The radioactive materials should be handled only by tongs or by a remote control device.
- Dosimeters should be worn by the users to check the level of radiation.

## 6.7 NUCLEAR REACTOR

A Nuclear reactor is a device in which the nuclear fission reaction takes place in a self-sustained and controlled manner to produce electricity. The first nuclear reactor was built in 1942 at Chicago, USA.

### 6.7.1 Types of nuclear reactors

Breeder reactor, fast breeder reactor, pressurized water reactor, pressurized heavy water reactor, boiling water reactor, water-cooled reactor, gas-cooled reactor, fusion reactor and thermal reactor are some types of nuclear reactors, which are used in different places world-wide.

### 6.7.2 Components of a nuclear reactors

The essential components of a nuclear reactor are (i) fuel, (ii) moderator, (iii) control rod, (iv) coolant and (v) protection wall.

- Fuel:** A fissile material is used as the fuel. The commonly used fuel material is uranium.
- Moderator:** A moderator is used to slow down the high energy neutrons to provide slow neutrons. Graphite and heavy water are the commonly used moderators.
- Control rod:** Control rods are used to control the number of neutrons in order to have sustained chain reaction. Mostly boron or cadmium rods are used as control rods. They absorb the neutrons.
- Coolant:** A coolant is used to remove the heat produced in the reactor core, to produce steam. This steam is used to run a turbine in order to produce electricity. Water, air and helium are some of the coolants.
- Protection wall:** A thick concrete lead wall is built around the nuclear reactor in order to prevent the harmful radiations from escaping into the environment.

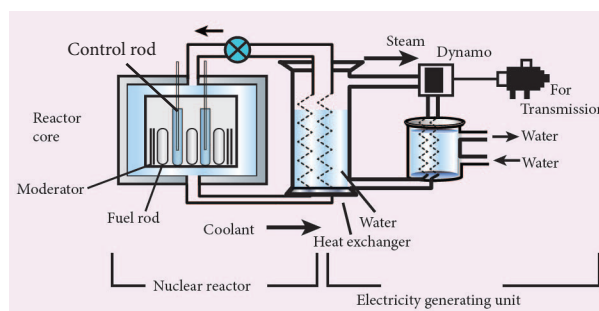

Figure 6.7 Schematic diagram of a nuclear reactor

### 6.7.3 Uses of a nuclear reactor

- Nuclear reactors are widely used in power generation.
- They are also used to produce radio isotopes, which are used in a variety of applications.
- Some reactors help us to do research in the field of nuclear physics.
- Breeder reactors are used to convert non-fissionable materials into fissionable materials.

### 6.7.4 Nuclear power plants in India

Indian Atomic Energy Commission (AEC) was established in August 1948 by the

Department of Indian Scientific Research committee at Bombay (now Mumbai) in Maharashtra. It is the nodal agency for all the research done in the field of atomic energy. Dr. Homi Jahangir Bhaba was the first chairman of Indian Atomic Energy Commission. Now, it is known as Bhaba Atomic Research Centre (BARC).

Nuclear power is the fifth largest source of power in India. Tarapur Atomic Power Station is India's first nuclear power station. Now, there are a total of seven power stations, one each in Maharashtra, Rajasthan, Gujarat, Uttar Pradesh and two in Tamilnadu. In Tamilnadu, we have nuclear power stations in Kalpakkam and Kudankulam. Apsara was the first nuclear reactor built in India and Asia. Now, there are 22 nuclear reactors which are operating in India. Some other operating reactors are

- Cirus
- Dhuruva
- Purnima

**Solved problem 6.1**

Identify A, B, C, and D from the following nuclear reactions.

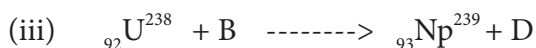
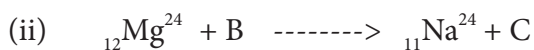
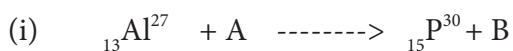

**Solution:**

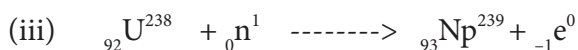
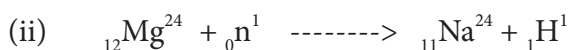
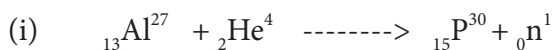

A is alpha particle, B is neutron, C is proton, and D is electron.

**Solved problem 6.2**

A radon specimen emits radiation of  $3.7 \times 10^3$  GBq per second. Convert this disintegration in terms of curie. (one curie =  $3.7 \times 10^{10}$  disintegration per second)

1 Bq = one disintegration per second  
 one curie =  $3.7 \times 10^{10}$  Bq

$$1 \text{ Bq} = \frac{1}{3.7 \times 10^{10}} \text{ curie}$$

$$\therefore 3.7 \times 10^3 \text{ GBq} = 3.7 \times 10^3 \times 10^9 \times \frac{1}{3.7 \times 10^{10}} = 100 \text{ curie}$$

**Solved problem 6.3**

${}_{92}\text{U}^{235}$  experiences one  $\alpha$  - decay and one  $\beta$  - decay. Find number of neutrons in the final daughter nucleus that is formed.

**Solution:**

Let X and Y be the resulting nucleus after the emission of the alpha and beta particles respectively.

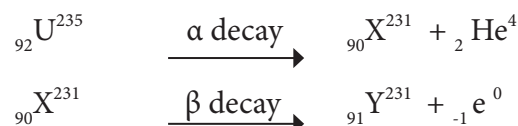

Number of neutrons = Mass number - Atomic number  
 = 231 - 91 = 140

**Solved problem 6.4**

Calculate the amount of energy released when a radioactive substance undergoes fusion and results in a mass defect of 2 kg.

**Solution:**

Mass defect in the reaction (m) = 2 kg

Velocity of light (c) =  $3 \times 10^8 \text{ m s}^{-1}$

By Einstein's equation,

Energy released  $E = mc^2$

So  $E = 2 \times (3 \times 10^8)^2 = 1.8 \times 10^{17} \text{ J}$

**Points to Remember**

- ❖ This phenomenon of spontaneous emission of radiation from certain elements on its own is called 'natural radioactivity'.
- ❖ **Curie** is defined as the quantity of a radioactive substance, which undergoes  $3.7 \times 10^{10}$  disintegrations in one second. This is actually close to the activity of 1 g of radium-226.

- ❖ **Rutherford (Rd)** is defined as the quantity of a radioactive substance which produces  $10^6$  disintegrations in one second.  
1 Rd =  $10^6$  disintegrations per second.
- ❖ The SI unit of radioactivity is **becquerel**. It is defined as the quantity of one disintegration per second.
- ❖ Helium nucleus ( ${}_2\text{He}^4$ ) consisting of two protons and two neutrons is known as alpha particle.
- ❖ Beta particles are electrons ( ${}_{-1}\text{e}^0$ ), which are the basic elementary particles present in all atoms.
- ❖ Gamma rays are electromagnetic waves consisting of photons.
- ❖ A nuclear reaction in which an unstable parent nucleus emits an alpha particle and forms a stable daughter nucleus is called as 'alpha decay'.
- ❖ A nuclear reaction in which an unstable parent nucleus emits a beta particle and



- forms a stable daughter nucleus is called as 'beta decay'.
- ❖ The process of breaking (splitting) up of a heavier nucleus into two smaller nuclei with the release of a large amount of energy is called '**nuclear fission**'.
- ❖ The energy released in a nuclear fission process is about 200 MeV.
- ❖ There are some radioactive elements which can be converted into a fissionable material. They are called as '**fertile materials**'. e.g. Uranium-238, Thorium-232, Plutonium-240.
- ❖ Controlled chain reaction is used in a nuclear reactor to produce energy in a sustained and controlled manner.
- ❖ The process in which two lighter nuclei combine to form a heavier nucleus is termed as '**nuclear fusion**'.
- ❖ Nuclear fusion or thermonuclear reaction is the source of light and heat energy in the Sun and other stars.
- ❖ The safe limit of receiving the radiation is about 100 mR per week.



## TEXTBOOK EVALUATION



### I. Choose the correct answer

1. Man-made radioactivity is also known as \_\_\_\_\_  
 a. Induced radioactivity  
 b. Spontaneous radioactivity  
 c. Artificial radioactivity  
 d. a & c
2. Unit of radioactivity is \_\_\_\_\_  
 a. roentgen                      b. curie  
 c. becquerel                      d. all the above
3. Artificial radioactivity was discovered by \_\_\_\_\_  
 a. Bequerel                      b. Irene Curie  
 c. Roentgen                      d. Neils Bohr
4. In which of the following, no change in mass number of the daughter nuclei takes place  
 i)  $\alpha$  decay                      ii)  $\beta$  decay  
 iii)  $\gamma$  decay                      iv) neutron decay  
 a. (i) is correct  
 b. (ii) and (iii) are correct  
 c. (i) & (iv) are correct  
 d. (ii) & (iv) are correct
5. \_\_\_\_\_ isotope is used for the treatment of cancer.

- a. Radio Iodine      b. Radio Cobalt
  - c. Radio Carbon      d. Radio Nickel
6. Gamma radiations are dangerous because
- a. it affects eyes & bones
  - b. it affects tissues
  - c. it produces genetic disorder
  - d. it produces enormous amount of heat
7. \_\_\_\_\_ aprons are used to protect us from gamma radiations
- a. Lead oxide      b. Iron
  - c. Lead      d. Aluminium
8. Which of the following statements is/are correct?
- i.  $\alpha$  particles are photons
  - ii. Penetrating power of  $\gamma$  radiation is very low
  - iii. Ionization power is maximum for  $\alpha$  rays
  - iv. Penetrating power of  $\gamma$  radiation is very high
- a. (i) & (ii) are correct
  - b. (ii) & (iii) are correct
  - c. (iv) only correct
  - d. (iii) & (iv) are correct
9. Proton - Proton chain reaction is an example of \_\_\_\_\_
- a. Nuclear fission      b.  $\alpha$  - decay
  - c. Nuclear fusion      d.  $\beta$  - decay
10. In the nuclear reaction  ${}_6X^{12} \xrightarrow{\alpha \text{ decay}} {}_Z Y^A$ , the value of A & Z.
- a. 8, 6      b. 8, 4
  - c. 4, 8      d. cannot be determined with the given data
11. Kamini reactor is located at \_\_\_\_\_
- a. Kalpakkam      b. Koodankulam
  - c. Mumbai      d. Rajasthan
12. Which of the following is/are correct?
- i. Chain reaction takes place in a nuclear reactor and an atomic bomb.
  - ii. The chain reaction in a nuclear reactor is controlled
  - iii. The chain reaction in a nuclear reactor is not controlled

- iv. No chain reaction takes place in an atom bomb
- a. (i) only correct      b. (i) & (ii) are correct
- c. (iv) only correct      d. (iii) & (iv) are correct

**II. Fill in the blanks**

1. One roentgen is equal to \_\_\_\_\_ disintegrations per second
2. Positron is an \_\_\_\_\_.
3. Anemia can be cured by \_\_\_\_\_ isotope
4. Abbreviation of ICRP \_\_\_\_\_
5. \_\_\_\_\_ is used to measure exposure rate of radiation in humans.
6. \_\_\_\_\_ has the greatest penetration power.
7.  ${}_Z Y^A \rightarrow {}_{Z+1} Y^A + X$ ; Then, X is \_\_\_\_\_
8.  ${}_Z X^A \rightarrow {}_Z Y^A$  This reaction is possible in \_\_\_\_\_ decay.
9. The average energy released in each fusion reaction is about \_\_\_\_\_ J.
10. Nuclear fusion is possible only at an extremely high temperature of the order of \_\_\_\_\_ K.
11. The radio isotope of \_\_\_\_\_ helps to increase the productivity of crops.
12. If the radiation exposure is 100 R, it may cause \_\_\_\_\_.

**III State whether the following statements are true or false: If false, correct the statement**

1. Plutonium -239 is a fissionable material.
2. Elements having atomic number greater than 83 can undergo nuclear fusion.
3. Nuclear fusion is more dangerous than nuclear fission.
4. Natural uranium U-238 is the core fuel used in a nuclear reactor.
5. If a moderator is not present, then a nuclear reactor will behave as an atom bomb.
6. During one nuclear fission on an average, 2 to 3 neutrons are produced.
7. Einstein's theory of mass energy equivalence is used in nuclear fission and fusion.

**IV. Match the following**

**Match: I**

- |                                       |           |
|---------------------------------------|-----------|
| a. BARC                               | Kalpakkam |
| b. India's first atomic power station | Apsara    |
| c. IGCAR                              | Mumbai    |
| d. First nuclear reactor in India     | Tarapur   |

**Match: II**

- |                 |              |
|-----------------|--------------|
| a. Fuel         | lead         |
| b. Moderator    | heavy water  |
| c. Control rods | cadmium rods |
| d. Shield       | uranium      |

**Match: III**

- |                    |                          |
|--------------------|--------------------------|
| a. Soddy Fajan     | Natural radioactivity    |
| b. Irene Curie     | Displacement law         |
| c. Henry Becquerel | Mass energy equivalence  |
| d. Albert Einstein | Artificial Radioactivity |

**Match: IV**

- |                                  |                 |
|----------------------------------|-----------------|
| a. Uncontrolled fission reaction | Hydrogen Bomb   |
| b. Fertile material              | Nuclear Reactor |
| c. Controlled fission reaction   | Breeder reactor |
| d. Fusion reaction               | Atom bomb       |

**Match: V**

- |            |                   |
|------------|-------------------|
| a. Co - 60 | Age of fossil     |
| b. I - 131 | Function of Heart |
| c. Na - 24 | Leukemia          |
| d. C - 14  | Thyroid disease   |

**V. Arrange the following in the correct sequence:**

- Arrange in descending order, on the basis of their penetration power**  
Alpha rays, beta rays, gamma rays, cosmic rays
- Arrange the following in the chronological order of discovery**  
Nuclear reactor, radioactivity, artificial radioactivity, discovery of radium.

**VI. Use the analogy to fill in the blank**

- Spontaneous process : Natural Radioactivity,  
Induced process : \_\_\_\_\_
- Nuclear Fusion : Extreme temperature,  
Nuclear Fission : \_\_\_\_\_
- Increasing crops : Radio phosphorous,  
Effective functioning of heart : \_\_\_\_\_
- Deflected by electric field :  $\alpha$  ray, Null Deflection : \_\_\_\_\_

**VII. Numerical problems:**

- ${}_{88}\text{Ra}^{226}$  experiences three  $\alpha$  - decay. Find the number of neutrons in the daughter element.
- A cobalt specimen emits induced radiation of 75.6 millicurie per second. Convert this disintegration in to becquerel (one curie =  $3.7 \times 10^{10}$  Bq)

**VIII. Assertion and reason type questions:**

**Mark the correct choice as**

- If both the assertion and the reason are true and the reason is the correct explanation of the assertion.
  - If both the assertion and the reason are true, but the reason is not the correct explanation of the assertion.
  - Assertion is true, but the reason is false.
  - Assertion is false, but the reason is true.
- Assertion:** A neutron impinging on  $\text{U}^{235}$ , splits it to produce Barium and Krypton.  
**Reason:** U - 235 is a fissile material.
  - Assertion:** In a  $\beta$  - decay, the neutron number decreases by one.  
**Reason:** In  $\beta$  - decay atomic number increases by one.
  - Assertion:** Extreme temperature is necessary to execute nuclear fusion.  
**Reason:** In a nuclear fusion, the nuclei of the reactants combine releasing high energy.



4. **Assertion:** Control rods are known as 'neutron seeking rods'  
**Reason:** Control rods are used to perform sustained nuclear fission reaction

**IX. Answer in one or two word (VSA)**

- Who discovered natural radioactivity?
- Which radioactive material is present in the ore of pitchblende?
- Write any two elements which are used for inducing radioactivity?
- Write the name of the electromagnetic radiation which is emitted during a natural radioactivity.
- If A is a radioactive element which emits an  $\alpha$  - particle and produces  ${}_{104}\text{Rf}^{259}$ . Write the atomic number and mass number of the element A.
- What is the average energy released from a single fission process?
- Which hazardous radiation is the cause for the genetic disease?
- What is the amount of radiation that may cause death of a person when exposed to it?
- When and where was the first nuclear reactor built?
- Give the SI unit of radioactivity.
- Which material protects us from radiation?

**X. Answer the following questions in few sentences.**

- Write any three features of natural and artificial radioactivity.
- Define critical mass.
- Define one roentgen.
- State Soddy and Fajan's displacement law.
- Give the function of control rods in a nuclear reactor.
- In Japan, some of the new born children are having congenital diseases. Why?
- Mr. Ramu is working as an X - ray technician in a hospital. But, he does not wear the lead aprons. What suggestion will you give to Mr. Ramu?

- What is stellar energy?
- Give any two uses of radio isotopes in the field of agriculture?

**XI. Answer the following questions in detail.**

- Explain the process of controlled and uncontrolled chain reactions.
- Compare the properties of alpha, beta and gamma radiations.
- What is a nuclear reactor? Explain its essential parts with their functions.

**XII. HOT Questions:**

- Mass number of a radioactive element is 232 and its atomic number is 90. When this element undergoes certain nuclear reactions, it transforms into an isotope of lead with a mass number 208 and an atomic number 82. Determine the number of alpha and beta decay that can occur.
- 'X - rays should not be taken often'. Give the reason.
- Cell phone towers should be placed far away from the residential area - why?



**REFERENCE BOOKS**

- Physics concepts and connections - by Art Hobson Edition: Pearson education
- Modern Physics - by Dr. R Murugesan & Er. KiruthigaSivaprasath-S.Chandpublications



**INTERNET RESOURCES**

- <https://physics.columbia.edu/research/nuclear-physics>
- [http://www.newworldencyclopedia.org/entry/Nuclear\\_physics](http://www.newworldencyclopedia.org/entry/Nuclear_physics)

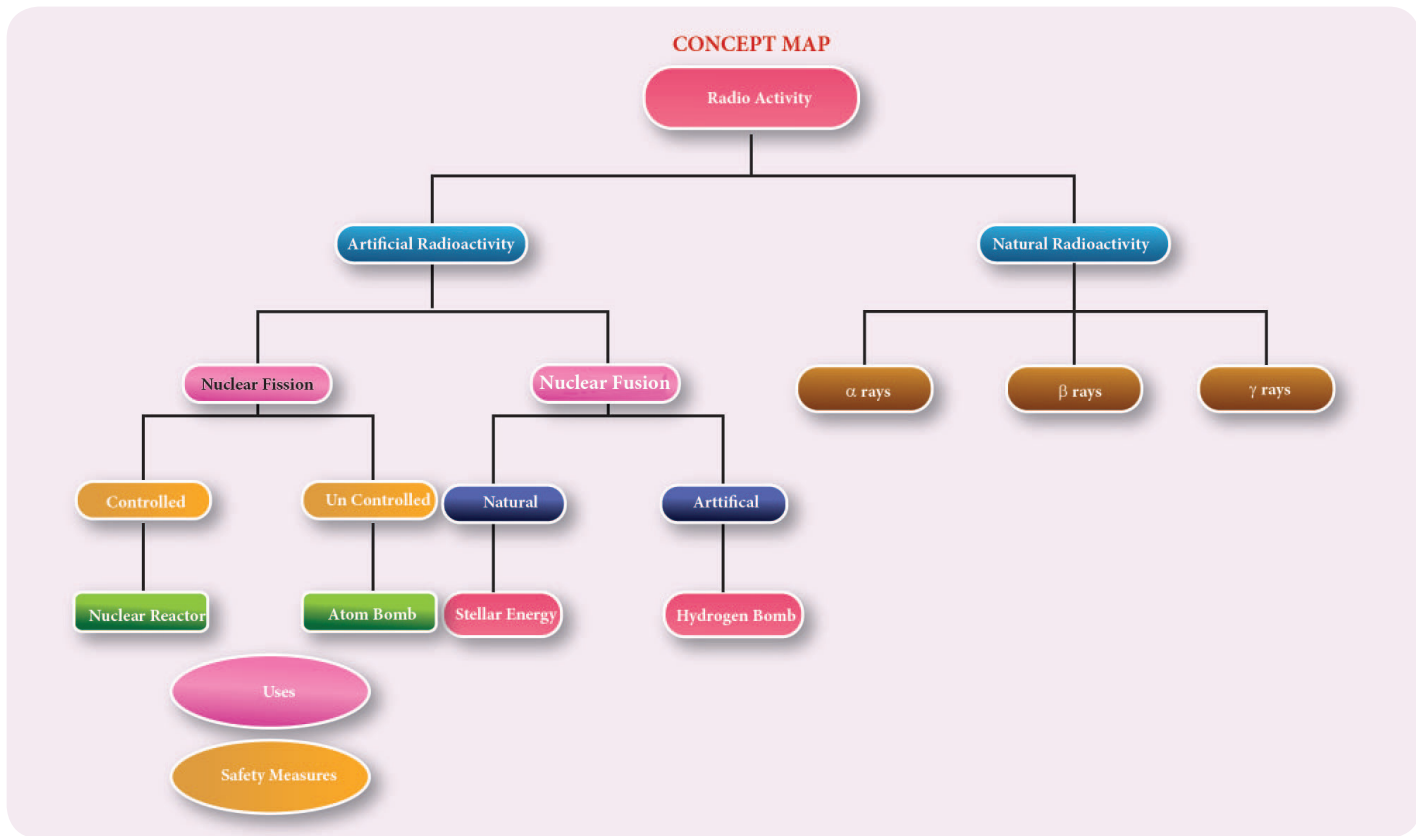

## ICT CORNER

## Modern Atomic Theory

To enable the students to build structure of different elements with electrons, protons and neutrons. They also know how new elements are formed as a result of Nuclear decays.

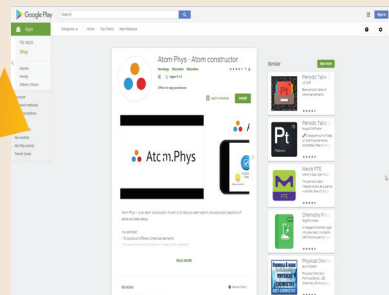

### Steps

- Access and download the application 'atom.phys' in your mobile by using the provided URL or QR code.
- Click '**Modeling**' to build the structure of an element by making changes in electron, proton and neutron.
- Click '**Nuclear decays**' to know how new elements are formed because of the decay/ destruction of atoms.
- Finally click '**Tests**' to check your knowledge by answering the questions.

### Cells alive

URL: <https://play.google.com/store/apps/details?id=com.CowboyBebop>.

AtomPhys&hl=en or Scan the QR Code.



B375\_10\_SCIENCE\_EM

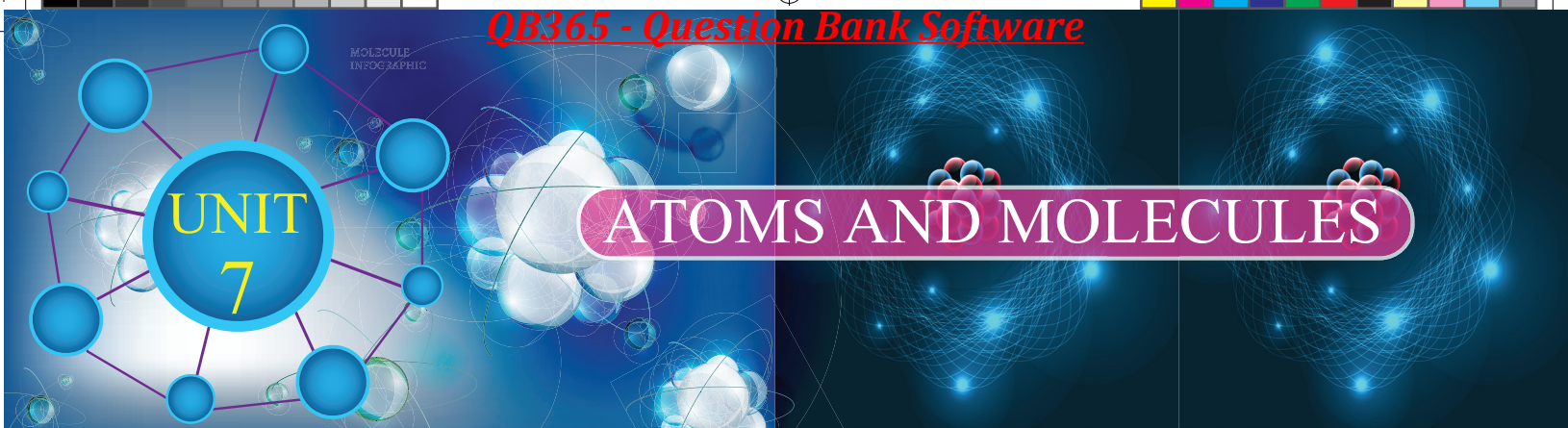

## Learning Objectives



At the end of the lesson the students will be able to:

- ◆ acquire the ability to learn about the atoms and molecules.
- ◆ comprehend atomic mass and molecular mass.
- ◆ have information about gram atomic mass and gram molecular mass.
- ◆ perceive the intended meaning of Avogadro's hypothesis of gases.
- ◆ interpret the application of Avogadro's hypothesis.
- ◆ determine the atomicity of a molecule.
- ◆ interpret the relation between vapour density and relative molecular mass.
- ◆ have the facts about the relationship between the volume of a gas and the number of molecules present in it.
- ◆ grasp the idea of mole concept and solve many problems using it.
- ◆ calculate the percentage of composition of a compound.

## INTRODUCTION

You have learnt, in your lower classes that matter is around us everywhere. Matter is made of atoms. Curiously the idea of atom was first proposed by the Greek philosophers in the fifth century BC (BCE). But, their theory was more philosophical than scientific.

The first scientific theory of the atom was proposed by John Dalton. Few of the postulates of Dalton's theory about an atom were found incorrect by the later on studies made by J.J. Thomson, Rutherford, Neils Bohr and Schrodinger. In the light of the result of the researches most of the limitations of the Dalton's theory were

removed and a new theory known as the modern atomic theory was put forward. 'The main postulates of modern atomic theory' are as follows:

- ◆ An atom is no longer indivisible (after the discovery of the electron, proton, and neutron).
- ◆ Atoms of the same element may have different atomic mass. (discovery of **isotopes**  $_{17}\text{Cl}^{35}$ ,  $_{17}\text{Cl}^{37}$ ).
- ◆ Atoms of different elements may have same atomic masses (discovery of **Isobars**  $_{18}\text{Ar}^{40}$ ,  $_{20}\text{Ca}^{40}$ ).
- ◆ Atoms of one element can be transmuted into atoms of other elements. In other words, atom is no longer indestructible (discovery of **artificial transmutation**).

- ◆ Atoms may not always combine in a simple whole number ratio (E.g. Glucose  $C_6H_{12}O_6$  C:H:O = 6:12:6 or 1:2:1 and Sucrose  $C_{12}H_{22}O_{11}$  C:H:O = 12:22:11).
- ◆ Atom is the **smallest particle that takes part in a chemical reaction.**
- ◆ The mass of an atom can be converted into energy ( $E = mc^2$ ).

The modern atomic theory is the basis for all the studies of chemical and physical processes that involve atoms. You have studied the most fundamental ideas about an atom in your lower classes. Let us discuss some more concepts about atoms in this lesson.

## 7.1 ATOM AND ATOMIC MASS

As you know, anything that has mass and occupies space is called matter. Atoms are the building blocks of matter. Since matter has mass, it must be due to its atoms. According to the modern atomic theory, an atom contains subatomic particles such as protons, neutrons and electrons. **Protons and neutrons have considerable mass, but electrons don't have such a considerable mass.** Thus, the mass of an atom is mainly contributed by its protons and neutrons and hence **the sum of the number of protons and neutrons of an atom is called its mass number.**

Individual atoms are very small and it is difficult to measure their masses. You can measure the mass of macroscopic materials in gram or kilogram. The mass of an atom is measured in atomic mass unit (amu).

Atomic mass unit is one-twelfth of the mass of a carbon-12 atom; an isotope of carbon, which contains 6 protons and 6 neutrons.

(**Note:** The symbol 'amu' is no longer used in the modern system and instead, it uses the symbol 'U' to denote unified atomic mass. The mass of a proton or neutron is approximately 1 amu).

### 7.1.1 Relative Atomic Mass (RAM)

As an atom is very small, its absolute mass cannot be determined directly. The early pioneers of chemistry used to measure the atomic mass of an atom relative to an atom of another element. They measured the masses of equal number of atoms of two or more elements at a time, to determine their relative masses. They established one element as a standard, gave it an arbitrary value of atomic mass and using this value they measured the relative mass of other elements. The mass obtained by this way is called relative atomic mass. In the beginning, the mass of hydrogen atom was chosen as a standard and masses of other atoms were compared with it, because of the existence of isotopic character of hydrogen ( ${}_1H^1$ ,  ${}_1H^2$ ,  ${}_1H^3$ ). Later hydrogen atom was replaced by oxygen atom as the standard. Now, the stable isotope of carbon (C-12) with atomic mass 12 is used as the standard for measuring the relative atomic mass of an element.

**Relative atomic mass of an element is the ratio between the average mass of its isotopes to  $\frac{1}{12}$ th part of the mass of a carbon-12 atom. It is denoted as  $A_r$ . It is otherwise called "Standard Atomic Weight".**

#### Relative Atomic Mass

$$(A_r) = \frac{\text{Average mass of the isotopes of the element}}{\frac{1}{12} \text{ of the mass of one Carbon-12 atom}}$$

Modern methods of determination of atomic mass by Mass Spectrometry uses C-12 as standard. For most of the elements, the relative atomic mass is very closer to a whole number and it is rounded off to a whole number, to make calculations easier. Table 7.1 lists some of the elements of periodic table and their  $A_r$  values.

**Table 7.1** Relative atomic mass of elements (C-12 Scale)

Element	Symbol	$A_r$
Hydrogen	H	1
Carbon	C	12
Nitrogen	N	14
Oxygen	O	16
Sodium	Na	23
Magnesium	Mg	24
Sulphur	S	32



Relative Atomic Mass is only a ratio, so it has no unit. If the atomic mass of an element is expressed in grams, it is called as **Gram Atomic Mass**

- Gram Atomic Mass of hydrogen = 1 g
- Gram Atomic Mass of carbon = 12 g
- Gram Atomic Mass of nitrogen = 14 g
- Gram Atomic Mass of oxygen = 16 g

### 7.1.2 Average Atomic Mass (AAM)

How can one measure the atomic mass of an element? It is somewhat more complicated because most of the naturally occurring elements exist as a mixture of isotopes, each of which has its own mass. Thus, it is essential to consider this isotopic mixture while calculating the atomic mass of an element.

**The average atomic mass of an element is the weighted average of the masses of its naturally occurring isotopes.**

But, the abundance of isotopes of each element may differ. So, the abundance of all these isotopes are taken into consideration while calculating the atomic mass. Then, what do we mean by a weighted average? Let us



consider an element which exists as a mixture of 50% of an isotope having a mass of 9 amu, and 50% of another isotope having a mass of 10 amu. Then, its average atomic mass is calculated by the following equation:

Average atomic mass

$$= (\text{Mass of 1st isotope} \times \% \text{ abundance of 1st isotope}) + (\text{Mass of 2nd isotope} \times \% \text{ abundance of 2nd isotope})$$

Thus, for the given element the average

$$\begin{aligned} \text{atomic mass} &= (9 \times \frac{50}{100}) + (10 \times \frac{50}{100}) \\ &= 4.5 + 5 = 9.5 \text{ amu} \end{aligned}$$

(Note: In the calculations involving percentages, you need to convert percentage abundance into fractional abundance. For example, 50 percent is converted into 50/100 or 0.50 as shown in the a foresaid calculation.)

The atomic masses of elements, given in the periodic table, are average atomic masses. Sometimes, the term atomic weight is used to mean average atomic mass. It is observed, from the periodic table that atomic masses of most of the elements are not whole numbers. For instance, the atomic mass of carbon given in the periodic table is 12.01 amu, not 12.00 amu. The reason is that while calculating the atomic mass of carbon, both of its natural isotopes such as carbon-12. and carbon-13 are considered. The natural abundance of C-12 and C-13 are 98.90 % and 1.10 % respectively. The average of the atomic mass of carbon is calculated as follows:

$$\begin{aligned} \text{Average atomic mass of carbon} &= (12 \times \frac{98.9}{100}) + (13 \times \frac{1.1}{100}) \\ &= (12 \times 0.989) + (13 \times 0.011) \\ &= 11.868 + 0.143 = 12.011 \text{ amu} \end{aligned}$$

So it is important to understand that if it is mentioned that the atomic mass of carbon is 12 amu, it refers to the average atomic mass of the carbon isotopes, not the mass of the individual atoms of carbon.

Table 7.2 Atomic mass of some elements

Atomic Number	Name	Symbol	Atomic Mass (amu)
1	Hydrogen	H	1.008
2	Helium	He	4.003
3	Lithium	Li	6.941
4	Beryllium	Be	9.012
5	Boron	B	10.811

Calculation of average atomic mass – Solved Examples

**Example 1:** Oxygen is the most abundant element in both the Earth’s crust and the human body. It exists as a mixture of three stable isotopes in nature as shown in Table 7.3:

Table 7.3 Isotopes of oxygen

Isotope	Mass (amu)	% abundance
${}_8\text{O}^{16}$	15.9949	99.757
${}_8\text{O}^{17}$	16.9991	0.038
${}_8\text{O}^{18}$	17.9992	0.205

The atomic mass of

$$\begin{aligned} \text{oxygen} &= (15.9949 \times 0.99757) + (16.9991 \times 0.00038) + (17.9992 \times 0.00205) \\ &= 15.999 \text{ amu.} \end{aligned}$$

**Example 2:** Boron naturally occurs as a mixture of boron-10 (5 protons + 5 neutrons) and boron-11 (5 protons + 6 neutrons) isotopes. The percentage abundance of B-10 is 20 and that of B-11 is 80. Then, the atomic mass of boron is calculated as follows:

Atomic mass of

$$\begin{aligned} \text{boron} &= \left(10 \times \frac{20}{100}\right) + \left(11 \times \frac{80}{100}\right) \\ &= (10 \times 0.20) + (11 \times 0.80) \\ &= 2 + 8.8 \\ &= 10.8 \text{ amu} \end{aligned}$$

7.2 MOLECULE AND MOLECULAR MASS

Except noble gases, atoms of most of the elements are found in the combined form with itself or atoms of other elements. It is called as a molecule. A **molecule is a combination of two or more atoms held together by strong chemical forces of attraction, i.e. chemical bonds.**

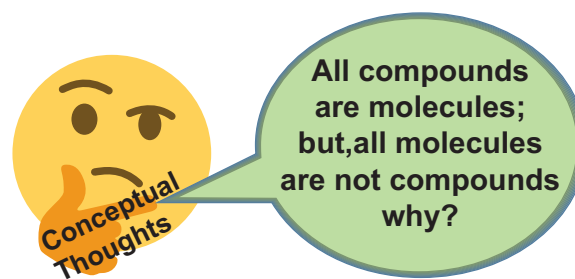

7.2.1 Classification of molecules

A molecule may contain atoms of the same element or may contain atoms of two or more elements joined in a fixed ratio, in accordance with the law of definite proportions. Thus, a molecule may be an **element or a compound**. If the molecule is made of similar kind of atoms, then it is called **homoatomic molecule**.

The molecule that consist of atoms of different elements is called **heteroatomic molecule**. A compound is a heteroatomic molecule. The number of atoms present in the molecule is called its ‘**atomicity**’.

Table 7.4 Classification of molecules

Atomicity	No. of atoms present	Name
1	1	Monoatomic
2	2	Diatomic
3	3	Triatomic
>3	>3	Polyatomic

Let us consider oxygen. Oxygen gas exists in two allotropic forms: Oxygen ( $\text{O}_2$ ) and Ozone ( $\text{O}_3$ ). In oxygen molecule, there are two oxygen atoms. So its atomicity is two. Since both the atoms are similar, oxygen ( $\text{O}_2$ ) is a homodiatom molecule. Other elements

**Activity 7.1**

Complete the following table by filling the appropriate values /terms

Element	No. of Protons	No. of Neutrons	Mass Number	Stable Isotopes (abundance)	Atomic Mass (amu)
	7			N-14 (99.6 %)	
		8		N-15 (0.4 %)	
Silicon	14		28	Si-28 (92.2 %)	
	14			Si-29 (4.7 %)	
		16		Si-30 (3.1 %)	
	17			Cl-35 (75 %)	
	17			Cl-37 (25 %)	

that exist as diatomic molecules are hydrogen (H<sub>2</sub>), nitrogen (N<sub>2</sub>) and halogens: fluorine (F<sub>2</sub>), chlorine (Cl<sub>2</sub>), bromine (Br<sub>2</sub>) and iodine (I<sub>2</sub>).

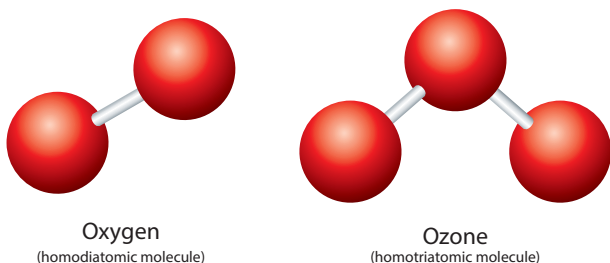

**Figure 7.1** Homoatomic molecules

Ozone (O<sub>3</sub>) contains three oxygen atoms and hence it is called homotriatomic molecule. If a molecule contains more than three atoms, then it is called **polyatomic molecule**.

Consider hydrogen chloride. It consists of two atoms, but of different elements, i.e. hydrogen and chlorine. So, its atomicity is two. It is a heterodiatom molecule. Similarly, the water molecule contains two hydrogen atoms and one oxygen atom. So its atomicity is three. It is a heterotriatomic molecule.

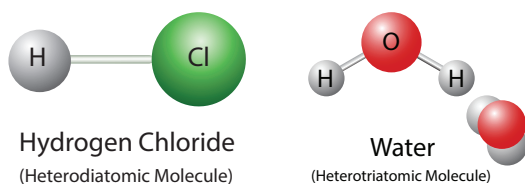

**Figure 7.2** Heteroatomic molecules

**Activity 7.2**

Classify the following molecules based on their atomicity and fill in the table:

Fluorine (F<sub>2</sub>), Carbon dioxide (CO<sub>2</sub>), Phosphorous (P<sub>4</sub>), Sulphur (S<sub>8</sub>), Ammonia (NH<sub>3</sub>), Hydrogen iodide (HI), Sulphuric Acid (H<sub>2</sub>SO<sub>4</sub>), Methane (CH<sub>4</sub>), Glucose (C<sub>6</sub>H<sub>12</sub>O<sub>6</sub>), Carbon monoxide (CO)

Molecule	Di - atomic	Tri - atomic	Poly - atomic
Homo			
Hetero			

**7.2.2 Relative Molecular Mass (RMM)**

As the molecules are made of atoms, they also have their own mass. The mass of the molecule of an element or compound is measured in the C-12 scale and hence called relative molecular mass.

The Relative Molecular Mass of a molecule is the ratio between the mass of one molecule of the substance to  $\frac{1}{12}$  mass of an atom of Carbon -12.



Relative Molecular Mass is only a ratio. So, it has no unit. If the molecular mass of a compound is expressed in grams, it is called **Gram Molecular Mass**.

Gram Molecular Mass of water	= 18 g
Gram Molecular Mass of carbon dioxide	= 44 g
Gram Molecular Mass of ammonia	= 17 g
Gram Molecular Mass of HCl	= 36.5 g

The relative molecular mass is obtained by adding together the relative atomic masses of all the atoms present in a molecule.

#### Calculation of relative molecular mass – Solved examples:

**Example 1:** Relative molecular mass of sulphuric acid ( $\text{H}_2\text{SO}_4$ ) is calculated as follows: Sulphuric acid contains 2 atoms of hydrogen, 1 atom of sulphur and 4 atoms of oxygen.

$$\begin{aligned} \text{Therefore, Relative molecular mass of sulphuric acid} &= (2 \times \text{mass of hydrogen}) + \\ &\quad (1 \times \text{mass of sulphur}) + \\ &\quad (4 \times \text{mass of oxygen}) \\ &= (2 \times 1) + (1 \times 32) + (4 \times 16) \\ &= 98 \end{aligned}$$

i.e., one molecule of  $\text{H}_2\text{SO}_4$  is 98 times as heavy as  $\frac{1}{12^{\text{th}}}$  of the mass of a carbon-12.

**Example 2:** Relative molecular mass of water ( $\text{H}_2\text{O}$ ) is calculated as follows: A water molecule is made of 2 atoms of hydrogen and one atom of oxygen.

$$\begin{aligned} \text{So, the relative molecular mass of water} &= (2 \times \text{mass of hydrogen}) + (1 \times \text{mass of oxygen}) \\ &= (2 \times 1) + (1 \times 16) \\ &= 18 \end{aligned}$$

i.e., one molecule of  $\text{H}_2\text{O}$  is 18 times as heavy as  $\frac{1}{12^{\text{th}}}$  of the mass of a carbon-12.

### 7.3 DIFFERENCE BETWEEN ATOMS AND MOLECULES

Even though atoms are the basic components of molecules, they differ in many aspects when compared to the molecules. Table 7.5 consolidates the major difference between atoms and molecules.

**Table 7.5** Difference between atoms and molecules

Atom	Molecule
An atom is the smallest particle of an element	A molecule is the smallest particle of an element or compound.
Atom does not exist in free state except in noble gas	Molecule exists in a free state
Except some of noble gas, other atoms are highly reactive	Molecules are less reactive
Atom does not have a chemical bond	Atoms in a molecule are held by chemical bonds

### 7.4 MOLE CONCEPT

So far we discussed about matters in terms of individual atoms and molecules. Atomic mass units provide a relative scale for the masses of the elements. Since the atoms have such small masses, no usable scale can be devised to weigh them in the calibrated units of atomic mass units. In any real situation, we deal with macroscopic samples containing enormous number of atoms. Therefore, it is convenient to have a special unit to describe a very large number of atoms. The idea of a 'unit' to denote a particular number of objects is not new. For example, **the pair (2 items) and the dozen (12 items)**, are all familiar units. Chemists measure atoms and molecules in 'moles'. So, you can now understand that 'mole' denotes a number of particles.



In the SI system, the *mole (mol)* is the amount of a substance that contains as many elementary entities (atoms, molecules, or other particles) as there are atoms in exactly 12 g (or 0.012 kg) of the carbon-12 isotope. The actual number of atoms in 12 g of carbon-12 is determined experimentally. This is called **Avogadro's Number ( $N_A$ )**, named after an Italian scientist **Amedeo Avogadro** who proposed its significance. Its value is  $6.023 \times 10^{23}$ . So one mole of a substance contains  $6.023 \times 10^{23}$  entities. Thus, 5 moles of oxygen molecules contain  $5 \times 6.023 \times 10^{23}$  molecules.

**Mole Concept:** The study of the collection of particles by using mole as the counting unit, in order to express the mass and volume of such unit particles in a bulk of matter is known as **mole concept**.

The number of moles of a substance can be calculated by various means depending on the data available, as follows:

- ◆ Number of moles of molecules.
- ◆ Number of moles of atoms.
- ◆ Number of moles of a gas (Standard molar volume at STP = 22.4 litre).
- ◆ Number of moles of ions.

**Note:**

STP-Standard Temperature and Pressure(273.15 K,1.00 atm)

**Mole of atoms:**

One mole of an element contains  $6.023 \times 10^{23}$  atoms and it is equal to its gram atomic mass.

i.e., one mole of oxygen atom contains  $6.023 \times 10^{23}$  atoms of oxygen and its gram atomic mass is 16 g.

**Mole of molecules:**

One mole of matter contains  $6.023 \times 10^{23}$  molecules and it is equal to its gram molecular mass.

i.e., one mole of oxygen molecule contains  $6.023 \times 10^{23}$  molecules of oxygen and its gram molecular mass is 32 g.

**Molar volume:**

One mole of any gas occupies 22.4 litre or 22400 ml at S.T.P. This volume is called as molar volume.

**Calculation of number of moles by Different modes**

- Number of moles
- = Mass / Atomic Mass
  - = Mass / Molecular mass
  - = Number of Atoms /  $6.023 \times 10^{23}$
  - = Number of Molecules /  $6.023 \times 10^{23}$

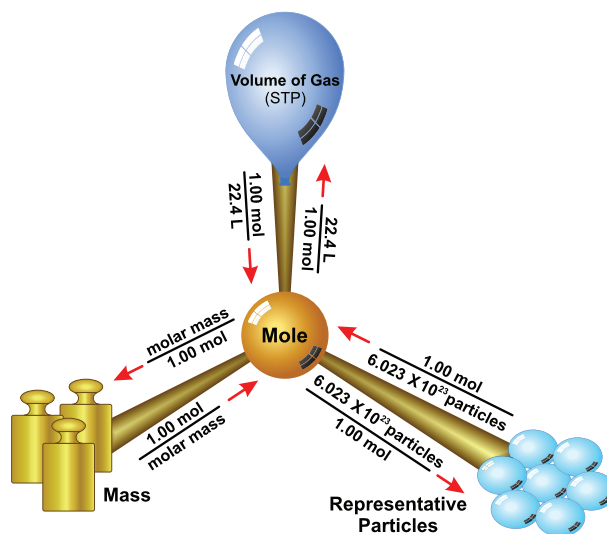

Figure 7.3 Mole concept

**7.5 PERCENT COMPOSITION**

So far, we were dealing with the number of entities present in a given substance. But many times, the information regarding the percentage of a particular element present in a compound is required.

The percentage composition of a compound represents the mass of each element present in 100 g of the compound.

Let us understand the percentage composition of oxygen and hydrogen by taking

the example of H<sub>2</sub>O. It can be calculated using the formula

$$\text{Mass \% of an element} = \frac{\text{mass of that element in the compound}}{\text{molecular mass of the compound}} \times 100$$

Now,

$$\begin{aligned} \text{molecular mass of H}_2\text{O} &= 2(1) + 16 \\ &= 18 \text{ g} \end{aligned}$$

$$\begin{aligned} \text{Mass \% of hydrogen} &= \frac{2}{18} \times 100 \\ &= 11.11 \% \end{aligned}$$

$$\begin{aligned} \text{Mass \% of oxygen} &= \frac{16}{18} \times 100 \\ &= 88.89 \% \end{aligned}$$

This percentage composition is useful to determine the empirical formula and molecular formula.

**Example 1:** Find the mass percentage composition of methane (CH<sub>4</sub>).

$$\begin{aligned} \text{molecular mass of CH}_4 &= 12 + 4 \\ &= 16 \text{ g} \end{aligned}$$

$$\begin{aligned} \text{Mass \% of carbon} &= \frac{12}{16} \times 100 \\ &= 75 \% \end{aligned}$$

$$\begin{aligned} \text{Mass \% of hydrogen} &= \frac{4}{16} \times 100 \\ &= 25 \% \end{aligned}$$

## 7.6 AVOGADRO HYPOTHESIS

In 1811 Avogadro framed a hypothesis based on the relationship between the number of molecules present in equal volumes of gases in different conditions.

The Avogadro's law states that *“equal volumes of all gases under similar conditions of temperature and pressure contain equal number of molecules”*

It follows that the volume of any given gas must be proportional to the number of molecules in it. If 'V' is the volume and 'n' is the

number of molecules of a gas, then Avogadro law is represented, mathematically, as follows:

$$\begin{aligned} V &\propto n \\ V &= \text{constant} \times n \end{aligned}$$

Thus, one litre (1 dm<sup>3</sup>) of hydrogen contains the same number of molecules as in one litre of oxygen, i.e. the volume of the gas is directly proportional to the number of molecules of the gas.

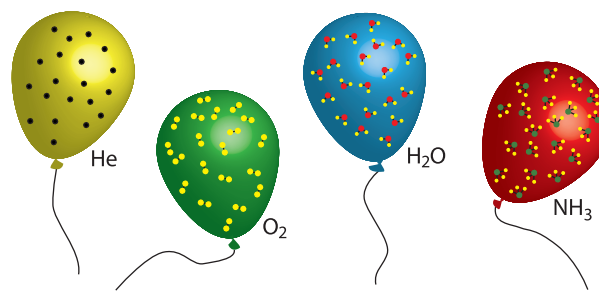
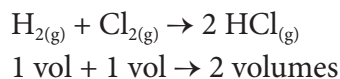

Figure 7.4 Avogadro Hypothesis

### Explanation

Let us consider the reaction between hydrogen and chlorine to form hydrogen chloride gas



According to Avogadro's law 1 volume of any gas is occupied by "n" number of molecules.  
n molecules + n molecules → 2n molecules

if n = 1 then

1 molecule + 1 molecule → 2 molecules.

½ molecule + ½ molecule → 1 molecule

1 molecule of hydrogen chloride gas is made up of ½ molecule of hydrogen and ½ molecule of chlorine. Hence, the molecules can be subdivided. This law is in agreement with Dalton's atomic theory.

### Activity 7.3

Under same conditions of temperature and pressure if you collect 3 litre of O<sub>2</sub>, 5 litre of Cl<sub>2</sub> and 6 litre of H<sub>2</sub>,

- Which has the highest number of molecules?
- Which has the lowest number of molecules?

**7.7 APPLICATIONS OF AVOGADRO'S LAW**

- i. It explains Gay-Lussac's law.
- ii. It helps in the determination of atomicity of gases.
- iii. Molecular formula of gases can be derived using Avogadro's law
- iv. It determines the relation between molecular mass and vapour density.
- v. It helps to determine gram molar volume of all gases (i.e, 22.4 litre at S.T.P)

**7.8 RELATIONSHIP BETWEEN VAPOUR DENSITY AND RELATIVE MOLECULAR MASS**

**i. Relative molecular mass: (Hydrogen scale)**

The Relative Molecular Mass of a gas or vapour is the ratio between the mass of one molecule of the gas or vapour to mass of one atom of Hydrogen.

**ii. Vapour Density:**

Vapour density is the ratio of the mass of a certain volume of a gas or vapour, to the mass of an equal volume of hydrogen, measured under the same conditions of temperature and pressure.

$$\text{Vapour Density (V.D.)} = \frac{\text{Mass of a given volume of gas or vapour at S.T.P.}}{\text{Mass of the same volume of hydrogen}}$$

According to Avogadro's law, equal volumes of all gases contain equal number of molecules.

Thus, let the number of molecules in one volume = n, then

$$\text{V.D. at S.T.P} = \frac{\text{Mass of 'n' molecules of a gas or vapour at S.T.P.}}{\text{Mass of 'n' molecules of hydrogen}}$$

Cancelling 'n' which is common, you get

$$\text{V.D.} = \frac{\text{Mass of 1 molecule of a gas or vapour at S.T.P.}}{\text{Mass of 1 molecules of hydrogen}}$$

However, since hydrogen is diatomic

$$\text{V.D.} = \frac{\text{Mass of 1 molecule of a gas or vapour at S.T.P.}}{\text{Mass of 2 atoms of hydrogen}}$$

When you compare the formula of vapour density with relative molecular mass, they can be represented as

$$\text{V.D.} = \frac{\text{Mass of 1 molecule of a gas or vapour at S.T.P.}}{2 \times \text{Mass of 1 atom of hydrogen}} \quad (\text{Eqn 7.1})$$

$$\text{Relative molecular mass (hydrogen scale)} = \frac{\text{Mass of 1 molecule of a gas or vapour at STP}}{\text{Mass of 1 atom of hydrogen}} \quad (\text{Eqn 7.2})$$

You can therefore substitute the above equation to an Eqn 7.1 and arrive at the following formula

$$\text{V.D.} = \frac{\text{Relative molecular mass}}{2}$$

Now on cross multiplication, you have

$$2 \times \text{vapour density} = \text{Relative molecular mass of a gas}$$

(Or)

$$\text{Relative molecular mass} = 2 \times \text{Vapour density}$$

**7.9 SOLVED PROBLEMS**

**I. Calculation of molecular mass**

Calculate the gram molecular mass of the following.

- 1) H<sub>2</sub>O      2) CO<sub>2</sub>      3) Ca<sub>3</sub>(PO<sub>4</sub>)<sub>2</sub>

**Solution:**

- 1) H<sub>2</sub>O

Atomic masses of H = 1, O = 16

Gram molecular mass of H<sub>2</sub>O  
 $= (1 \times 2) + (16 \times 1)$   
 $= 2 + 16$

Gram molecular mass of H<sub>2</sub>O = 18 g

2) CO<sub>2</sub>

Atomic masses of C = 12, O = 16

Gram molecular mass of CO<sub>2</sub>  
 $= (12 \times 1) + (16 \times 2)$   
 $= 12 + 32$

Gram molecular mass of CO<sub>2</sub> = 44 g

3) Ca<sub>3</sub>(PO<sub>4</sub>)<sub>2</sub>

Atomic masses of Ca = 40, P = 30, O = 16.

Gram molecular mass of Ca<sub>3</sub>(PO<sub>4</sub>)<sub>2</sub>  
 $= (40 \times 3) + [30 + (16 \times 4)] \times 2$   
 $= 120 + (94 \times 2)$   
 $= 120 + 188$

Gram molecular mass of Ca<sub>3</sub>(PO<sub>4</sub>)<sub>2</sub> = 308 g

### II. Calculation based on number of moles from mass and volume

1) Calculate the number of moles in 46 g of sodium?

$$\text{Number of moles} = \frac{\text{Mass of the element}}{\text{Atomic mass of the element}}$$

$$= 46 / 23$$

$$= 2 \text{ moles of sodium}$$

2) 5.6 litre of oxygen at S.T.P

$$\text{Number moles} = \frac{\text{Given volume of O}_2 \text{ at S.T.P}}{\text{Molar volume at S.T.P}}$$

$$\text{Number of moles of oxygen} = \frac{5.6}{22.4}$$

$$= 0.25 \text{ mole of oxygen}$$

3) Calculate the number of moles of a sample that contains  $12.046 \times 10^{23}$  atoms of iron ?

$$\text{Number of moles} = \frac{\text{Number of atoms of iron}}{\text{Avogadro's number}}$$

$$= 12.046 \times 10^{23} / 6.023 \times 10^{23}$$

$$= 2 \text{ moles of iron}$$

### III. Calculation of mass from mole

Calculate the mass of the following

1) 0.3 mole of aluminium (Atomic mass of Al = 27)

$$\text{Number of moles} = \frac{\text{Mass of Al}}{\text{Atomic mass of Al}}$$

$$\text{Mass} = \text{No. of moles} \times \text{atomic mass}$$

$$\text{So, mass of Al} = 0.3 \times 27$$

$$= 8.1 \text{ g}$$

2) 2.24 litre of SO<sub>2</sub> gas at S.T.P

$$\text{Molecular mass of SO}_2 = 32 + (16 \times 2)$$

$$= 32 + 32 = 64$$

$$\text{Number of moles of SO}_2 = \frac{\text{Given volume of SO}_2 \text{ at S.T.P}}{\text{Molar volume SO}_2 \text{ at S.T.P}}$$

$$\text{Number of moles of SO}_2 = \frac{2.24}{22.4}$$

$$= 0.1 \text{ mole}$$

$$\text{Number of moles} = \frac{\text{Mass}}{\text{Molecular mass}}$$

$$\text{Mass} = \text{No. of moles} \times \text{molecular mass}$$

$$\text{Mass} = 0.1 \times 64$$

$$\text{Mass of SO}_2 = 6.4 \text{ g}$$

3)  $1.51 \times 10^{23}$  molecules of water

$$\text{Molecular mass of H}_2\text{O} = 18$$

$$\text{Number of moles} = \frac{\text{Number of molecules of water}}{\text{Avogadro's number}}$$

$$= 1.51 \times 10^{23} / 6.023 \times 10^{23}$$

$$= 1 / 4$$

$$= 0.25 \text{ mole}$$

$$\text{Number of moles} = \frac{\text{Mass}}{\text{Molecular mass}}$$

$$0.25 = \text{mass} / 18$$

$$\text{Mass} = 0.25 \times 18$$

$$\text{Mass} = 4.5 \text{ g}$$

4)  $5 \times 10^{23}$  molecules of glucose ?

$$\text{Molecular mass of glucose} = 180$$

$$\begin{aligned} \text{Mass of glucose} &= \frac{\text{Molecular mass} \times \text{number of particles}}{\text{Avogadro's number}} \\ &= \frac{(180 \times 5 \times 10^{23})}{6.023 \times 10^{23}} \\ &= 149.43 \text{ g} \end{aligned}$$

**IV. Calculation based on number of atoms/molecules.**

1) Calculate the number of molecules in 11.2 litre of CO<sub>2</sub> at S.T.P

$$\begin{aligned} \text{Number of moles of CO}_2 &= \frac{\text{Volume at S.T.P}}{\text{Molar volume}} \\ &= \frac{11.2}{22.4} \\ &= 0.5 \text{ mole} \end{aligned}$$

$$\begin{aligned} \text{Number of molecules of CO}_2 &= \text{number of moles of CO}_2 \times \text{Avogadro's number} \\ &= 0.5 \times 6.023 \times 10^{23} \\ &= 3.011 \times 10^{23} \text{ molecules of CO}_2 \end{aligned}$$

2) Calculate the number of atoms present in 1 gram of gold (Atomic mass of Au = 198)

$$\text{Number of atoms of Au} = \frac{\text{Mass of Au} \times \text{Avogadro's number}}{\text{Atomic mass of Au}}$$

$$\text{Number of atoms of Au} = \frac{1}{198} \times 6.023 \times 10^{23}$$

$$\text{Number of atoms of Au} = 3.042 \times 10^{21} \text{ g}$$

3) Calculate the number of molecules in 54 gm of H<sub>2</sub>O?

$$\text{Number of molecules} = \frac{(\text{Avogadro number} \times \text{Given mass})}{\text{Gram molecular mass}}$$

$$\begin{aligned} \text{Number of molecules of water} &= 6.023 \times 10^{23} \times 54 / 18 \\ &= 18.069 \times 10^{23} \text{ molecules} \end{aligned}$$

4) Calculate the number of atoms of oxygen and carbon in 5 moles of CO<sub>2</sub>.

- 1 mole of CO<sub>2</sub> contains 2 moles of oxygen
- 5 moles of CO<sub>2</sub> contain 10 moles of oxygen

$$\begin{aligned} \text{Number of atoms of oxygen} &= \text{Number of moles of oxygen} \times \text{Avogadro's number} \\ &= 10 \times 6.023 \times 10^{23} \\ &= 6.023 \times 10^{24} \text{ atoms of Oxygen} \end{aligned}$$

- 1 mole of CO<sub>2</sub> contains 1 mole of carbon
- 5 moles of CO<sub>2</sub> contains 5 moles of carbon

$$\text{No. of atoms of carbon} = \frac{\text{No. of moles of carbon}}{\times \text{Avogadro's number}}$$

$$\begin{aligned} &= 5 \times 6.023 \times 10^{23} \\ &= 3.011 \times 10^{24} \text{ atoms of Carbon} \end{aligned}$$

**V. Calculation based on molar volume**

Calculate the volume occupied by:

1) 2.5 mole of CO<sub>2</sub> at S.T.P

$$\text{Number of moles of CO}_2 = \frac{\text{Given volume at S.T.P}}{\text{Molar volume at S.T.P}}$$

$$2.5 \text{ mole of CO}_2 = \frac{\text{Volume of CO}_2 \text{ at S.T.P}}{22.4}$$

$$\begin{aligned} \text{Volume of CO}_2 \text{ at S.T.P} &= 22.4 \times 2.5 \\ &= 56 \text{ litres.} \end{aligned}$$

2) 12.046 × 10<sup>23</sup> of ammonia gas molecules

$$\begin{aligned} \text{Number of moles} &= \frac{\text{Number of molecules}}{\text{Avogadro's number}} \\ &= \frac{12.046 \times 10^{23}}{6.023 \times 10^{23}} \\ &= 2 \text{ moles} \end{aligned}$$

Volume occupied by NH<sub>3</sub>

$$\begin{aligned} &= \text{number of moles} \times \text{molar volume} \\ &= 2 \times 22.4 \\ &= 44.8 \text{ litres at S.T.P} \end{aligned}$$

3) 14 g nitrogen gas

$$\begin{aligned} \text{Number of moles} &= 14 / 28 \\ &= 0.5 \text{ mole} \end{aligned}$$

Volume occupied by N<sub>2</sub> at S.T.P

$$\begin{aligned} &= \text{no. of moles} \times \text{molar volume} \\ &= 0.5 \times 22.4 \\ &= 11.2 \text{ litres.} \end{aligned}$$

**VI. Calculation based on % composition**

Calculate % of S in H<sub>2</sub>SO<sub>4</sub>

molecular mass of H<sub>2</sub>SO<sub>4</sub>

$$= (1 \times 2) + (32 \times 1) + (16 \times 4)$$

$$= 2 + 32 + 64$$

$$= 98 \text{ g}$$

$$\% \text{ of S in H}_2\text{SO}_4 = \frac{\text{Mass of sulphur}}{\text{Molecular mass of H}_2\text{SO}_4} \times 100$$

$$\% \text{ of S in H}_2\text{SO}_4 = \frac{32}{98} \times 100$$

$$= 32.65 \%$$

**Points to Remember**

- ❖ Two or more forms of an element having the same atomic number, but different mass number are called Isotopes ( $_{17}\text{Cl}^{35}$ ,  $_{17}\text{Cl}^{37}$ ).
- ❖ Atoms of different elements having the same mass number, but different atomic numbers are called Isobars ( $_{18}\text{Ar}^{40}$ ,  $_{20}\text{Ca}^{40}$ ).
- ❖ Atoms of different elements having the same number of neutrons, but different atomic number and different mass number are called Isotones ( $_6\text{C}^{13}$ ,  $_7\text{N}^{14}$ ).
- ❖ Relative atomic mass of an element is the ratio between the mass of one atom of the element to 1/12th of the mass of the atom of carbon -12.
- ❖ Average atomic mass of an element is calculated by adding the masses of its isotopes, each multiplied by their natural abundance on the Earth.
- ❖ Relative molecular mass of a molecule is the ratio between the mass of one molecule of the substance to 1/12th of the mass of the atom of carbon - 12.
- ❖ The Avogadro's law states that "equal volumes of all gases under similar conditions of temperature and pressure contain equal number of molecules".
- ❖ The vapour density is defined as "the ratio between the masses of equal volumes of a gas (or a vapour) and hydrogen under the same condition".
- ❖ Atomicity of a monoatomic element = Molecular mass / Atomic Mass.
- ❖ Molecular mass = 2 × Vapour density.



**TEXTBOOK EVALUATION**



**I. Choose the best answer.**

1. Which of the following has the smallest mass?
  - a.  $6.023 \times 10^{23}$  atoms of He
  - b. 1 atom of He
  - c. 2 g of He
  - d. 1 mole atoms of He
2. Which of the following is a triatomic molecule?
  - a. Glucose
  - b. Helium
  - c. Carbon dioxide
  - d. Hydrogen
3. The volume occupied by 4.4 g of CO<sub>2</sub> at S.T.P
  - a. 22.4 litre
  - b. 2.24 litre
  - c. 0.24 litre
  - d. 0.1 litre
4. Mass of 1 mole of Nitrogen atom is
  - a. 28 amu
  - b. 14 amu
  - c. 28 g
  - d. 14 g
5. Which of the following represents 1 amu?
  - a. Mass of a C - 12 atom
  - b. Mass of a hydrogen atom
  - c. 1/12<sup>th</sup> of the mass of a C - 12 atom
  - d. Mass of O - 16 atom

6. Which of the following statement is incorrect?
  - a. 12 gram of C – 12 contains Avogadro's number of atoms.
  - b. One mole of oxygen gas contains Avogadro's number of molecules.
  - c. One mole of hydrogen gas contains Avogadro's number of atoms.
  - d. One mole of electrons stands for  $6.023 \times 10^{23}$  electrons.
7. The volume occupied by 1 mole of a diatomic gas at S.T.P is
  - a. 11.2 litre
  - b. 5.6 litre
  - c. 22.4 litre
  - d. 44.8 litre
8. In the nucleus of  ${}_{20}\text{Ca}^{40}$ , there are
  - a. 20 protons and 40 neutrons
  - b. 20 protons and 20 neutrons
  - c. 20 protons and 40 electrons
  - d. 40 protons and 20 electrons
9. The gram molecular mass of oxygen molecule is
  - a. 16 g
  - b. 18 g
  - c. 32 g
  - d. 17 g
10. 1 mole of any substance contains \_\_\_\_\_ molecules.
  - a.  $6.023 \times 10^{23}$
  - b.  $6.023 \times 10^{-23}$
  - c.  $3.0115 \times 10^{23}$
  - d.  $12.046 \times 10^{23}$

**II. Fill in the blanks**

1. Atoms of different elements having \_\_\_\_\_ mass number, but \_\_\_\_\_ atomic numbers are called isobars.
2. Atoms of different elements having same number of \_\_\_\_\_ are called isotones.
3. Atoms of one element can be transmuted into atoms of other element by \_\_\_\_\_
4. The sum of the numbers of protons and neutrons of an atom is called its \_\_\_\_\_
5. Relative atomic mass is otherwise known as \_\_\_\_\_

6. The average atomic mass of hydrogen is \_\_\_\_\_ amu.
7. If a molecule is made of similar kind of atoms, then it is called \_\_\_\_\_ atomic molecule.
8. The number of atoms present in a molecule is called its \_\_\_\_\_
9. One mole of any gas occupies \_\_\_\_\_ ml at S.T.P
10. Atomicity of phosphorous is \_\_\_\_\_

**III. Match the following**

- |                              |   |            |
|------------------------------|---|------------|
| 1. 8 g of O <sub>2</sub>     | - | 4 moles    |
| 2. 4 g of H <sub>2</sub>     | - | 0.25 moles |
| 3. 52 g of He                | - | 2 moles    |
| 4. 112 g of N <sub>2</sub>   | - | 0.5 moles  |
| 5. 35.5 g of Cl <sub>2</sub> | - | 13 moles   |

**IV. True or False: (If false give the correct statement)**

1. Two elements sometimes can form more than one compound.
2. Noble gases are Diatomic
3. The gram atomic mass of an element has no unit
4. 1 mole of Gold and Silver contain same number of atoms
5. Molar mass of CO<sub>2</sub> is 42g.

**V. Assertion and Reason:**

**Answer the following questions using the data given below:**

- i) A and R are correct, R explains the A.
- ii) A is correct, R is wrong.
- iii) A is wrong, R is correct.
- iv) A and R are correct, R doesn't explains A.

1. **Assertion:** The Relative Atomic mass of aluminium is 27

**Reason:** An atom of aluminium is 27 times heavier than 1/12th of the mass of the C – 12 atom.

2. **Assertion:** The Relative Molecular Mass of Chlorine is 35.5 a.m.u.

**Reason:** The natural abundance of Chlorine isotopes are not equal.

**VI. Short answer questions**

1. Define: Relative atomic mass.
2. Write the different types of isotopes of oxygen and its percentage abundance.
3. Define: Atomicity
4. Give any two examples for heterodiatomic molecules.
5. What is Molar volume of a gas?
6. Find the percentage of nitrogen in ammonia.

**VII. Long answer questions**

1. Calculate the number of water molecule present in one drop of water which weighs 0.18 g.



(The atomic mass of nitrogen is 14, and that of hydrogen is 1)

1 mole of nitrogen ( \_\_\_\_\_ g) +  
 3 moles of hydrogen ( \_\_\_\_\_ g) →  
 2 moles of ammonia ( \_\_\_\_\_ g)

3. Calculate the number of moles in  
 i) 27g of Al    ii)  $1.51 \times 10^{23}$  molecules of  $NH_4Cl$
4. Give the salient features of “Modern atomic theory”.
5. Derive the relationship between Relative molecular mass and Vapour density.

**VIII. HOT question**

1. Calcium carbonate is decomposed on heating in the following reaction



- i. How many moles of Calcium carbonate are involved in this reaction?

- ii. Calculate the gram molecular mass of calcium carbonate involved in this reaction
- iii. How many moles of  $CO_2$  are there in this equation?

**IX. Solve the following problems**

1. How many grams are there in the following?
  - i. 2 moles of hydrogen molecule,  $H_2$
  - ii. 3 moles of chlorine molecule,  $Cl_2$
  - iii. 5 moles of sulphur molecule,  $S_8$
  - iv. 4 moles of phosphorous molecule,  $P_4$
2. Calculate the % of each element in calcium carbonate. (Atomic mass: C-12, O-16, Ca -40)
3. Calculate the % of oxygen in  $Al_2(SO_4)_3$ . (Atomic mass: Al-27, O-16, S -32)
4. Calculate the % relative abundance of B-10 and B-11, if its average atomic mass is 10.804 amu.



**REFERENCE BOOKS**

- 1) Petrucci, Ralph H et.al. General Chemistry: Principles & Modern Applications (9th Edition). Upper Saddle River, NJ: Pearson Prentice Hall, 2007. Print.
- 2) Raymond Chang. (2010). Chemistry. New York, NY: The Tata McGraw Hill Companies. Inc.
- 3) Julia Burdge. (2011). Chemistry. New York, NY: The Tata McGraw Hill Companies.Inc.



**INTERNET RESOURCES**

<https://www2.estrellamountain.edu/faculty/farabee/biobk/BioBookCHEM1.html>

<https://www.toppr.com/guides/chemistry/atoms-and-molecules/>



### CONCEPT MAP

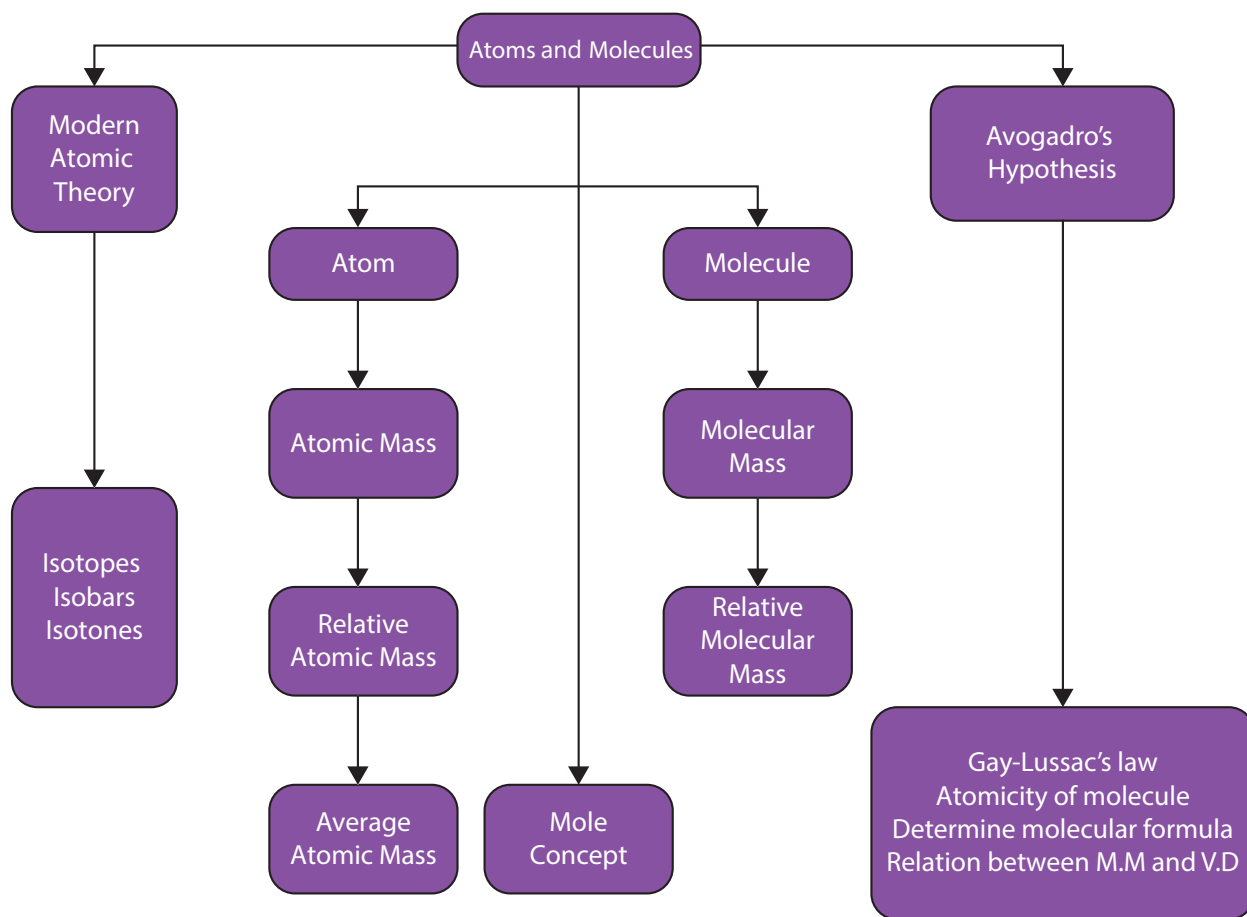

The top section features a central graphic for 'UNIT 8' with a network of blue circles. To its right is a diagram showing two hydrogen atoms (H) and two chlorine atoms (Cl) interacting. One H-Cl bond is labeled 'Weak Pull' and another 'Strong Pull'. Below, a reaction shows two H atoms and two Cl atoms with the text 'Electron transferred'. On the far right is a standard periodic table with various element groups highlighted in different colors (Metal, Nonmetal, etc.).

# PERIODIC CLASSIFICATION OF ELEMENTS



## Learning Objectives

After a thorough perusal of this unit, the students will be able to:

- ◆ recognize the basis of the modern periodic law and its development.
- ◆ list the features of groups and periods of the modern periodic table.
- ◆ explain the trend in periodic properties along the periods and groups.
- ◆ distinguish between ores and minerals .
- ◆ list out the types of separation of impurities from the ores.
- ◆ recall the various places of occurrences of minerals in the state of Tamil Nadu.
- ◆ put forth the properties of metals.
- ◆ identify the stages involved in metallurgical processes.
- ◆ think scientifically on alloys and their types.
- ◆ develop an idea on amalgam.
- ◆ understand the reason for corrosion and the methods of its prevention.



## INTRODUCTION

The eighteenth and nineteenth centuries witnessed a rapid development in chemistry in all spheres of scientific activities. By 1860, scientists had already discovered 60 elements and determined their atomic masses. They noticed that some elements had similar properties and hence arranged them into groups. During this period, several new elements were discovered. These elements were found to have different properties. It was realized that instead of studying the properties of all these elements individually, it would be more convenient to divide them into groups and

periods in such a way that each group contained a certain number of elements (**like an array of fruits and vegetables showing orderliness**) with similar properties and periods showing a regular gradation. So, scientists made several attempts to arrange elements in a logical way. You have studied about all these early attempts of arrangement of elements in standard IX. In continuation of the knowledge gained in the topic **periodic classification of elements** in standard IX with earlier concepts and their subsequent deliberations, you get set to go ahead with the higher order of thinking to enhance your knowledge on the properties of elements.

## 8.1 MODERN PERIODIC LAW

Mendeleev's periodic table had some discrepancies, which were difficult to overcome. For example, the atomic mass of argon (39.95 amu) is greater than that of potassium (39.10 amu), but argon comes before potassium in the periodic table. If elements were arranged solely according to increasing atomic mass, argon would appear in the position occupied by potassium in our modern periodic table (see in Figure 8.1). No chemist would place argon, a gas with no tendency to react, in the same group as lithium and sodium, which are two highly reactive metals. This kind of discrepancies suggested that some fundamental property other than atomic mass must be the basis of periodicity. The fundamental property turned out to be the number of protons in an atom's nucleus, something that could not have been known by Mendeleev and his contemporaries.

Henry Moseley, a British scientist in 1912, discovered a new property of elements called atomic number, which provided a better basis for the periodic arrangement of the elements. It is a well-known fact that atomic number of an element is equal to the number of protons or the number of electrons present in the neutral atom of an element. The periodic law was, therefore, modified to frame a **modern periodic law**, which states that

**“The physical and chemical properties of the elements are the periodic functions of their atomic numbers”.**

## 8.2 MODERN PERIODIC TABLE

With reference to the modern periodic law, the elements were arranged in the increasing order of their atomic numbers to form the modern periodic table. **The modern periodic table is a tabular arrangement of elements in periods and groups, highlighting the regular repetition of properties of the elements.**

Figure 8.1 shows the modern periodic table of 118 elements discovered so far.

As you have studied the features of the modern periodic table in standard IX, here let us confine to the study of the features of periods and groups.

### 8.2.1 Features of Periods

- ◆ The **horizontal rows are called periods**. There are **seven** periods in the periodic table.
- ◆ **First period** (Atomic number 1 and 2): This is the shortest period. It contains only two elements (Hydrogen and Helium).
- ◆ **Second period** (Atomic number 3 to 10): This is a short period. It contains eight elements (Lithium to Neon).
- ◆ **Third period** (Atomic number 11 to 18): This is also a short period. It contains eight elements (Sodium to Argon).
- ◆ **Fourth period** (Atomic number 19 to 36): This is a long period. It contains eighteen elements (Potassium to Krypton). This includes 8 representative elements and 10 transition elements.
- ◆ **Fifth period** (Atomic number 37 to 54): This is also a long period. It contains 18 elements (Rubidium to Xenon). This includes 8 representative elements and 10 transition elements.
- ◆ **Sixth period** (Atomic number 55 to 86): This is the longest period. It contains 32 elements (Caesium to Radon). This includes 8 representative elements, 10 transition elements and 14 inner transition elements (Lanthanides).
- ◆ **Seventh period** (Atomic number 87 to 118): Like the sixth period, this period also accommodates 32 elements. Recently 4 elements have been included by IUPAC.

# PERIODIC TABLE OF THE ELEMENTS

PERIOD	GROUP	1	2	3	4	5	6	7	8	9	10	11	12	13	14	15	16	17	18	
		IA	IIA	IIIB	IVB	VB	VIB	VII	VIII	VIII	VIII	IB	IIB	IIIA	IVA	VA	VIA	VIIA	VIIIA	
		1	2	3	4	5	6	7	8	9	10	11	12	13	14	15	16	17	18	
1	1	1.008 <b>H</b> HYDROGEN																	4.0026 <b>He</b> HELIUM	
2	2	6.94 <b>Li</b> LITHIUM	9.0122 <b>Be</b> BERYLLIUM											10.81 <b>B</b> BORON	12.011 <b>C</b> CARBON	14.007 <b>N</b> NITROGEN	15.999 <b>O</b> OXYGEN	18.998 <b>F</b> FLUORINE	20.180 <b>Ne</b> NEON	
3	3	22.990 <b>Na</b> SODIUM	24.305 <b>Mg</b> MAGNESIUM	44.956 <b>Sc</b> SCANDIUM	47.867 <b>Ti</b> TITANIUM	50.942 <b>V</b> VANADIUM	51.996 <b>Cr</b> CHROMIUM	54.938 <b>Mn</b> MANGANESE	55.845 <b>Fe</b> IRON	58.933 <b>Co</b> COBALT	58.693 <b>Ni</b> NICKEL	63.546 <b>Cu</b> COPPER	65.38 <b>Zn</b> ZINC	26.982 <b>Al</b> ALUMINIUM	28.085 <b>Si</b> SILICON	30.974 <b>P</b> PHOSPHORUS	32.06 <b>S</b> SULPHUR	35.45 <b>Cl</b> CHLORINE	39.948 <b>Ar</b> ARGON	
4	4	39.098 <b>K</b> POTASSIUM	40.078 <b>Ca</b> CALCIUM	88.906 <b>Y</b> YTTORIUM	47.867 <b>Ti</b> TITANIUM	50.942 <b>V</b> VANADIUM	51.996 <b>Cr</b> CHROMIUM	54.938 <b>Mn</b> MANGANESE	55.845 <b>Fe</b> IRON	58.933 <b>Co</b> COBALT	58.693 <b>Ni</b> NICKEL	63.546 <b>Cu</b> COPPER	65.38 <b>Zn</b> ZINC	69.723 <b>Ga</b> GALLIUM	72.64 <b>Ge</b> GERMANIUM	74.922 <b>As</b> ARSENIC	78.971 <b>Se</b> SELENIUM	79.904 <b>Br</b> BROMINE	83.798 <b>Kr</b> KRYPTON	
5	5	85.468 <b>Rb</b> RUBIDIUM	87.62 <b>Sr</b> STRONTIUM	88.906 <b>Y</b> YTTORIUM	91.224 <b>Zr</b> ZIRCONIUM	92.906 <b>Nb</b> NIOBIUM	95.95 <b>Mo</b> MOLYBDENUM	98 <b>Tc</b> TECHNETIUM	101.07 <b>Ru</b> RUTHENIUM	102.91 <b>Rh</b> RHODIUM	106.42 <b>Pd</b> PALLADIUM	107.87 <b>Ag</b> SILVER	112.41 <b>Cd</b> CADMIUM	114.82 <b>In</b> INDIUM	118.71 <b>Sn</b> TIN	121.76 <b>Sb</b> ANTIMONY	127.60 <b>Te</b> TELLURIUM	126.90 <b>I</b> IODINE	131.29 <b>Xe</b> XENON	
6	6	132.91 <b>Cs</b> CAESIUM	137.33 <b>Ba</b> BARIUM	137.33 <b>La-Lu</b> Lanthanide	178.49 <b>Hf</b> HAFNIUM	180.95 <b>Ta</b> TANTALUM	183.84 <b>W</b> TUNGSTEN	186.21 <b>Re</b> RHENIUM	195.08 <b>Pt</b> PLATINUM	196.97 <b>Hg</b> MERCURY	200.59 <b>Tl</b> THALLIUM	204.38 <b>Pb</b> LEAD	207.2 <b>Bi</b> BISMUTH	208.98 <b>Po</b> POLONIUM	208.98 <b>At</b> ASTATINE	209 <b>Po</b> POLONIUM	209 <b>At</b> ASTATINE	210 <b>Rn</b> RADON	222 <b>Rn</b> RADON	
7	7	223 <b>Fr</b> FRANCIUM	226 <b>Ra</b> RADIUM	226 <b>Ac-Lr</b> Actinide	267 <b>Rf</b> RUTHERFORDIUM	268 <b>Db</b> DUBNIUM	271 <b>Sg</b> SEABORGIUM	272 <b>Bh</b> BOHRNIUM	277 <b>Hs</b> HASSIUM	285 <b>Cn</b> COPECNICIUM	285 <b>Fl</b> FLEROVIUM	285 <b>Mc</b> MOSCOWIUM	285 <b>Lv</b> LIVERMORIUM	285 <b>Ts</b> TENNESSE	285 <b>Og</b> OGANESSON	285 <b>Og</b> OGANESSON	285 <b>Og</b> OGANESSON	285 <b>Og</b> OGANESSON	285 <b>Og</b> OGANESSON	285 <b>Og</b> OGANESSON

RELATIVE ATOMIC MASS (1)

GROUP IUPAC

GROUP CAS

ATOMIC NUMBER

SYMBOL

ELEMENT NAME

Metal  
 Alkali metal  
 Alkaline earth metal  
 Transition metals  
 Lanthanide  
 Actinide  
 Semimetal  
 Chalcogens element  
 Halogens element  
 Noble gas  
 Nonmetal

STANDARD STATE (25 °C; 101 kPa)

Ne - gas  
 Hg - liquid  
 Fe - solid  
 Tc - synthetic

LANTHANIDE

ACTINIDE

57 138.91 <b>La</b> LANTHANUM	58 140.12 <b>Ce</b> CERIUM	59 140.91 <b>Pr</b> PRASEODYMIUM	60 144.24 <b>Nd</b> NEODYMIUM	61 (145) <b>Pm</b> PROMETHIUM	62 150.36 <b>Sm</b> SAMARIUM	63 151.96 <b>Eu</b> EUROPIUM	64 157.25 <b>Gd</b> GADOLINIUM	65 158.93 <b>Tb</b> TERBIUM	66 162.50 <b>Dy</b> DYSPROSIUM	67 164.93 <b>Ho</b> HOLMIUM	68 167.26 <b>Er</b> ERBIUM	69 168.93 <b>Tm</b> THULIUM	70 173.05 <b>Yb</b> YTTERIUM	71 174.97 <b>Lu</b> LUTETIUM
89 (227) <b>Ac</b> ACTINIUM	90 232.04 <b>Th</b> THORIUM	91 231.04 <b>Pa</b> PROTACTINIUM	92 238.03 <b>U</b> URANIUM	93 (237) <b>Np</b> NEPTUNIUM	94 (244) <b>Pu</b> PLUTONIUM	95 (243) <b>Am</b> AMERICIUM	96 (247) <b>Cm</b> CURIUM	97 (247) <b>Bk</b> BERKELIUM	98 (251) <b>Cf</b> CALIFORNIUM	99 (252) <b>Es</b> EINSTEINIUM	100 (257) <b>Fm</b> FERMIUM	101 (258) <b>Md</b> MENDELEVIUM	102 (259) <b>No</b> NOBELIUM	103 (262) <b>Lr</b> LAWRENCIUM

Copyright © 2017 Eri Generalit



(1) Atomic weights of the elements 2013, Pure Appl. Chem., 88, 265-291 (2016)

\*(CAS) Chemical Abstract Service | \*(IUPAC) International union of Pure and Applied Chemistry

Figure 8.1 Modern Periodic Table

### 8.2.2 Features of Groups

- ◆ The vertical columns in the periodic table starting from top to bottom are called **groups**. There are **18 groups** in the periodic table.
- ◆ Based on the common characteristics of elements in each group, they can be grouped as various families.

Group Number	Family
1	Alkali Metals
2	Alkaline earth metals
3 to 12	Transition metals
13	Boron Family
14	Carbon Family
15	Nitrogen Family
16	Oxygen Family (or) Chalcogen family
17	Halogens
18	Noble gases

- ◆ The Lanthanides and Actinides, which form part of Group 3 are called **inner transition elements**.
- ◆ Except 'group 18', all the elements present in each group have the same number of electrons in their valence shell and thus have the same valency. For example, all the elements of group 1 have one electron in their valence shells ( $1s^1$ ). So, the valency of all the alkali metals is '1'.
- ◆ As the elements present in a group have identical valence shell electronic configurations, they possess similar chemical properties.
- ◆ The physical properties of the elements in a group such as melting point, boiling point and density vary gradually.
- ◆ The atoms of the 'group 18' elements have stable electronic configuration in their valence shells and hence they are unreactive.

### 8.3 PERIODIC TRENDS IN PROPERTIES

The electronic configurations of elements help us to explain the periodic recurrence of physical and chemical properties. Anything which repeats itself after a regular



interval is called **periodic** and this behaviour is called **periodicity**. Some of the atomic properties of the elements are periodic.

Properties such as atomic radius, ionic radius, ionisation energy, electronegativity, electron affinity, show a regular periodicity and hence they are called **periodic properties**. The main significance of the modern periodic table is that it gives a clear understanding of the general properties and trends within a group or a period to predict with considerable accuracy, the properties of any element, even though that element may be unfamiliar to us. Let us discuss the periodic trend of some of the properties.

#### 8.3.1 Atomic Radius

**Atomic radius** of an atom is defined as the distance between the centre of its nucleus and the outermost shell containing the valence electron. Direct measurement of the radius of an isolated atom is not possible. Except for noble gases, usually the atomic radius is referred to as **covalent radius** or **metallic radius** depending on the nature of the bonding between the concerned atoms. Atomic radius in metal atoms is known as **metallic radius**. It is defined as **half the distance between the nuclei of adjacent metal atoms** (Figure 8.2

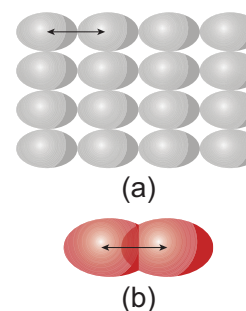

**Figure 8.2**  
(a) Metallic Radius  
(b) Covalent Radius

(a). In non-metallic elements, their atomic radius is known as **Covalent radius**. It is defined as **half the distance between the adjacent nuclei of two covalently bonded atoms of the same element in a molecule** (Figure 8.2 (b)). For example, let us consider  $H_2$  molecule. The distance between the two hydrogen nuclei of the molecule is  $0.74 \text{ \AA}$ . So its covalent radius is  $0.74/2 = 0.37 \text{ \AA}$ .

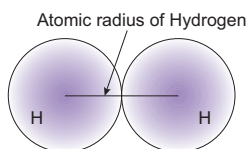

**Figure 8.3**  
Atomic radius

When you look at the variation of the atomic radii in the periodic table, there are two distinct trends.



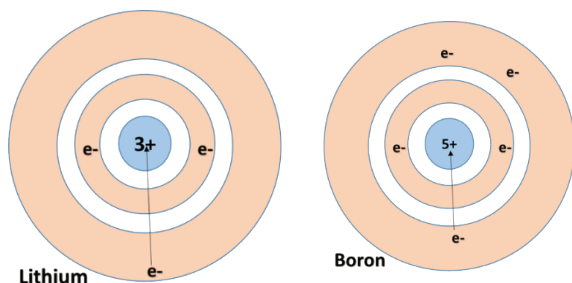





Along the period, from left to right, the atomic radius of the elements decreases whereas along the groups, from the top to bottom, the atomic radius increases. The increase, down a group, is due to the increase in the valence shell number down the group. As the shell number increases, the distance between the valence shell and the nucleus increases. In contrast, when you observe along the period, the shell number remains the same but the number of protons (i.e. atomic number) increases. More and more positive charges impose a strong attraction over the electrons and thus the electron cloud shrinks towards the nucleus, which results in the decrease in the atomic size. Figure 8.4 shows how the atomic radius decreases from lithium to boron.



**Figure 8.4** Variation of atomic radius

### 8.3.2 Ionic Radii

It is defined as the distance from the centre of the nucleus of the ion upto the point where it exerts its influence on the electron cloud of

Li	Li <sup>+</sup>	F	F <sup>-</sup>
			
156	90	69	119
Na	Na <sup>+</sup>	Cl	Cl <sup>-</sup>
			
186	116	91	167

Radii in Picometers

**Figure 8.5** Relative ionic radii of cation and anion

the ion. You know that ions are formed when an atom lose or gain electrons. When a neutral atom loses an electron, it becomes a positively charged ion called **cation**, whereas the gain of an electron by a neutral atom forms a negatively charged ion called **anion**. The size of the ions is important to determine their behaviours in solutions and the structure of ionic solids. The size of a cation is always smaller than its corresponding neutral atom. But, the anion is larger than its neutral atom.

**Note:** As the positive charge increases the size of the cation decreases  
As the negative charge increases the size of the anion increases

For instance, lithium and sodium lose the single electron from their outermost energy level to form cations. The ions so formed are smaller because the remaining electrons are at a inner cells and attracted more strongly by the nucleus. Fluorine and chlorine become negative ions by gaining an electron. When electrons are added, the charge on the nucleus is not great enough to hold the increased number of electrons as closely as it holds the electrons in the neutral atom. So, **as seen in atomic radius, ionic radii also decrease along the period from left to right and increase down the group.**

### 8.3.3 Ionisation Energy

Ionisation energy is the minimum energy required to remove an electron from

an isolated gaseous atom in its ground state to form a cation. It is otherwise called **ionisation enthalpy**. It is measured in kJ/mol. Higher the ionisation energy, it is more difficult to remove the electron.

As the atomic size decreases from left to right in a period, more energy is required to remove the electrons. **So, the ionisation energy increases along the period.** But, down the group, the atomic size increases and hence the valence electrons are loosely bound. They require relatively less energy for the removal. Thus, **ionisation energy decreases down the group in the periodic table.**

### 8.3.4 Electron Affinity

Electron affinity is the amount of energy released when an isolated gaseous atom gains an electron to form its anion. It is also measured in kJ/mol and represented by the following equation:

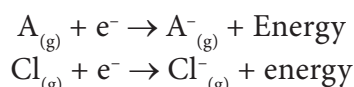

Like ionisation energy, electron affinity also increases from left to right in a period and decreases from top to bottom in a group.

#### More to Know

Noble gases show no tendency to accept electrons because the outer s and p orbitals of noble gases are completely filled. No more electrons can be added to them and hence their electron affinities are zero.

### 8.3.5 Electronegativity

Electronegativity of an element is the measure of the tendency of its atom to attract the shared pair of electrons towards itself in a covalent bond. Let us consider HCl molecule. Both the hydrogen and chlorine atoms share one electron each to form the covalent bond between them. Chlorine atom has a higher electronegativity and hence it pulls the shared electrons towards

itself more strongly than hydrogen. Thus, when the bond breaks, the bonding electrons are left with chlorine forming  $H^{+}$  and  $Cl^{-}$  ions. It is represented, diagrammatically, as shown below:

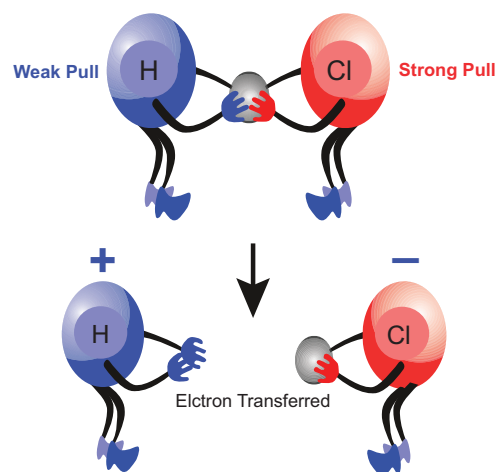

**Figure 8.6** Relative electronegativity of H and Cl

Electronegativity is based on various experimental data such as bond energy, ionization potential, electron affinity, etc.

Pauling scale is the widely used scale to determine the electronegativity, which in turn predicts the nature of bonding (ionic or covalent) between the atoms in a molecule.

Electronegativity of some of the elements are given below

F = 4.0, Cl = 3.0, Br = 2.8, I = 2.5, H = 2.1, Na = 1

If the difference in electronegativity between two elements is 1.7, the bond has 50% ionic character and 50% covalent character.

If the difference is less than 1.7, the bond is considered to be more covalent.

If the difference is greater than 1.7, the bond is considered to be more ionic.

Along the period, from left to right in the periodic table, the electronegativity increases because of the increase in the nuclear charge which in turn attracts the electrons more strongly. On moving down a group, the electronegativity of the elements decreases because of the increased number of valence shells.

Periodic Property	In Periods	In Groups
Atomic radius	Decreases	Increases
Ionic radius	Decreases	Increases
Ionisation energy	Increases	Decreases
Electron affinity	Increases	Decreases
Electronegativity	Increases	Decreases

### Test yourself

Predict the nature of the bond in the following molecules.

- (i) NaCl      (ii) NaBr      (iii) NaI  
 (iv) NaF      (v) NaH

## 8.4 METALLURGY

Human life is associated with various metals. We use metals in our day to day activities. It is the utmost need to have some metals like sodium, potassium, calcium, iron, etc. in the human body. Deficiency of these metals affects the metabolic activities thereby causing diseases. So, metals play a vital role in our life. In this section, let us discuss how metals are obtained from various sources by the process of metallurgy.



**Metallurgy is a science of extracting metals from their ores and modifying the metals into alloys for various uses, based on their physical and chemical properties and their structural arrangement of atoms.** A metallurgical process involve three main steps as follows:

- (i) **Concentration or Separation of the ore:**  
It is the process of removal of impurities from the ore.
- (ii) **Production of the metal:** It is the conversion of the ore into metal.

- (iii) **Refining of the metal:** It is the process of purification of the metal.

### 8.4.1 Terminology in metallurgy

**Minerals:** A mineral may be a single compound or a complex mixture of various compounds of metals found in the Earth.

**Ore:** The mineral from which a metal can be readily and economically extracted on a large scale is said to be an ore.

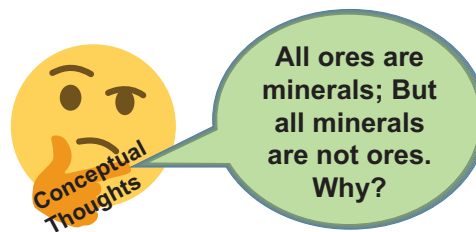

**For example:** Clay ( $\text{Al}_2\text{O}_3 \cdot 2 \text{SiO}_2 \cdot 2 \text{H}_2\text{O}$ ) and bauxite ( $\text{Al}_2\text{O}_3 \cdot 2 \text{H}_2\text{O}$ ) are the two minerals of aluminium, but aluminium can be profitably extracted only from bauxite. Hence, bauxite is an ore of aluminium and clay is its mineral.

**Mining:** The process of extracting the ores from the Earth's crust is called mining.

**Gangue or Matrix:** The rocky impurity associated with an ore is called gangue or matrix.

**Flux:** It is the substance added to the ore to reduce the fusion temperature and to remove the impurities. E.g. Calcium oxide (basic), Silica (acidic). If the gangue is acidic, then basic flux is added and vice versa.

**Slag:** It is the fusible product formed when a flux reacts with a gangue during the extraction of metals.



**Smelting:** Smelting is the process of reducing the roasted metallic oxide from the metal in its molten condition. In this process, impurities are removed as slag by the addition of flux.

### 8.4.2 Types of separation or concentration of an ore

There are four major types of separation of ores based on the nature of the ore. The



different kinds of ores of metals are given in Table 8.1

Concentration of the crushed ore is done mainly by the following methods: -

(i) **Hydraulic (Gravity Separation) method**

**Principle:** The difference in the densities or specific gravities of the ore and the gangue is the main principle behind this method. Oxide ores are purified by this method. e.g., Haematite  $Fe_2O_3$  the ore of iron.

Note: When the ore is heavier than the impurity, this method can be used.

**Method:** The ore is poured over a sloping, vibrating corrugated table with grooves and a jet of water is allowed to flow over it. The denser ore particles settle down in the grooves and lighter gangue particles are washed down by water.

(ii) **Magnetic separation method**

**Principle:** The magnetic properties of the ores form the basis of separation. When either the ore or the gangue is magnetic, this method is employed. e.g., Tinstone  $SnO_2$ , the ore of tin.

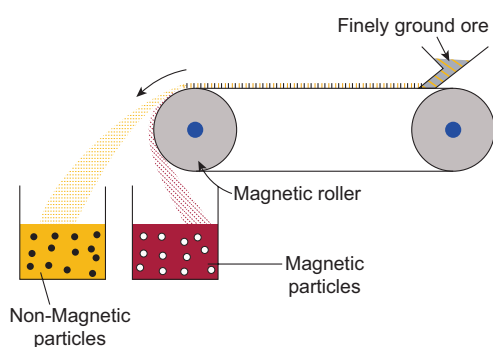

Figure 8.8 Magnetic separation

**Method:** The crushed ore is placed over a conveyer belt which rotates around two

metal wheels, one of which is magnetic. The magnetic particles are attracted to the magnetic wheel and fall separately apart from the non-magnetic particles.

(iii) **Froth floatation**

**Principle:** This process depends on the preferential wettability of the ore with oil (pine oil) and the gangue particles by water. Lighter ores, such as sulphide ores, are concentrated by this method. e.g., Zinc blende ( $ZnS$ ).

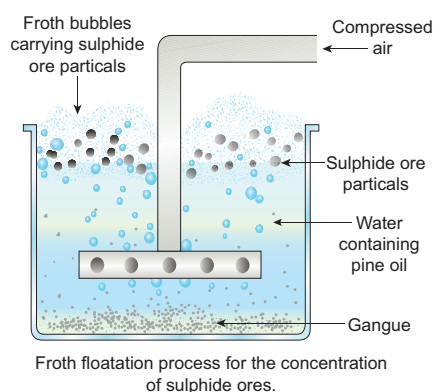

Figure 8.9 Froth floatation

Note: When the impurity is heavier than the ore, this method can be used.

**Method:** The crushed ore is taken in a large tank containing pine oil and water and agitated with a current of compressed air. The ore is wetted by the oil and gets separated from the gangue in the form of froth. Since the ore is lighter, it comes on the surface with the froth and the impurities are left behind. e.g., Zinc blende ( $ZnS$ ).

(iv) **Chemical method or Leaching**

This method is employed when the ore is in a very pure form.

Table 8.1 Types of ores

Oxide Ores	Carbonate Ores	Halide Ores	Sulphide Ores
Bauxite ( $Al_2O_3 \cdot 2H_2O$ )	Marble ( $CaCO_3$ )	Cryolite ( $Na_3AlF_6$ )	Galena ( $PbS$ )
Cuprite ( $Cu_2O$ )	Magnesite ( $MgCO_3$ )	Fluorspar ( $CaF_2$ )	Iron pyrite ( $FeS_2$ )
Haematite ( $Fe_2O_3$ )	Siderite ( $FeCO_3$ )	Rock salt ( $NaCl$ )	Zinc blende ( $ZnS$ )

**More to Know**

Extraction of metal from metal oxide can be categorized into three types.

More reactive metals	Medium reactive metals	Less reactive metals
Na,K,Ca,Mg,Al	Zn,Fe,Pb,Cu	Ag,Hg
Electrolytic reduction of metal oxide into metal	Chemical reduction of metal oxide into metal using coke	Thermal decomposition of metal oxide into metal

The ore is treated with a suitable reagent such that the ore is soluble in it but the impurities are not. The impurities are removed by filtration. The solution of the ore, i.e., the filtrate is treated with a suitable reagent which precipitates the ore. E.g. Bauxite  $Al_2O_3 \cdot 2H_2O$ , (the ore of aluminium).

**8.5 OCCURRENCE OF ORES IN TAMIL NADU**

**Lime stone:** Coimbatore, Cuddalore, Dindugul

**Gypsum:** Tiruchi and Coimbatore Distiricts

**Titanium minerals:** Kanyakumari, Tirunelveli and Tuticorin.

**Chromite:** Coimbatore and Salem district.

**Magnetite:** Dharmapuri, Erode, Salem, Thiruvannamalai.

**Tungsten:** Madurai and Dindugul.

(Reference: mineral resources of Tamil Nadu-ENVIS Centre, Tamil Nadu)

**8.6 PROPERTIES OF METALS**

**8.6.1 Physical properties**

- Physical state:** All metals are solids at room temperature except mercury and gallium.
- Lustre:** Metals possess a high lustre (called metallic lustre).
- Hardness:** Most of the metals are hard and strong (exceptions: sodium and potassium can be cut with a knife)
- Melting point and Boiling point:** Usually, metals possess high melting and

boiling points and vaporize only at high temperatures (exceptions: gallium, mercury, sodium and potassium).

- Density:** Metals have a high density (exceptions: sodium and potassium are less dense than water).
- Ductility:** Metals are usually ductile. In other words, they can be drawn into thin wires without breaking.
- Malleability:** Metals are usually malleable, i.e, they can be beaten into thin sheets without cracking (except zinc and mercury).
- Conduction of heat and electricity:** Metals are good conductors of heat and electricity; silver and copper excel in this property (exception: tungsten)
- Solubility:** Usually, metals do not dissolve in liquid solvents.

**8.6.2 Chemical Properties**

- Valence electrons:** Atoms of metals usually have 1,2 or 3 electrons in their outermost shell.
- Formation of ions:** Metals form Positive ions by the loss of electrons and hence they are electro positive.
- Discharge of ions:** Metals are discharged at the cathode during the electrolysis of their compounds.
- Atomicity:** Molecules of metals in their vapour state are usually monoatomic.
- Nature of oxides:** Oxides of metals are usually basic.

## 8.7 METALLURGY OF ALUMINIUM

Aluminium is the metal found most abundantly in the Earth's crust. Since it is a reactive metal, it occurs in the combined state. The important ores of aluminium are as follows

Ores of Aluminium	Formula
Bauxite	$\text{Al}_2\text{O}_3 \cdot 2\text{H}_2\text{O}$
Cryolite	$\text{Na}_3\text{AlF}_6$
Corundum	$\text{Al}_2\text{O}_3$

Bauxite is the chief ore of aluminium. The extraction of aluminium from bauxite involves two steps:

### (i) Conversion of bauxite into alumina - Baeyer's Process

The conversion of Bauxite into Alumina involves the following steps:

Bauxite ore is finely ground and heated under pressure with a solution of concentrated caustic soda solution at  $150^\circ\text{C}$  to obtain sodium meta aluminate.

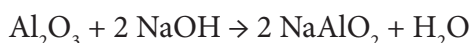

On diluting sodium meta aluminate with water, a precipitate of aluminium hydroxide is formed.

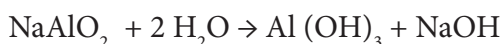

The precipitate is filtered, washed, dried and ignited at  $1000^\circ\text{C}$  to get alumina.

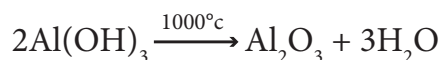

### (ii) Electrolytic reduction of alumina - Hall's Process

Aluminium is produced by the electrolytic reduction of fused alumina ( $\text{Al}_2\text{O}_3$ ) in the electrolytic cell.

**Cathode:** Iron tank lined with graphite

**Anode:** A bunch of graphite rods suspended in molten electrolyte.

**Electrolyte:** Pure alumina+ molten cryolite + fluorspar (fluorspar lowers the fusion temperature of electrolyte)

Temperature:  $900 - 950^\circ\text{C}$

Voltage used: 5-6 V

Overall reaction:  $2 \text{Al}_2\text{O}_3 \rightarrow 4 \text{Al} + 3 \text{O}_2 \uparrow$

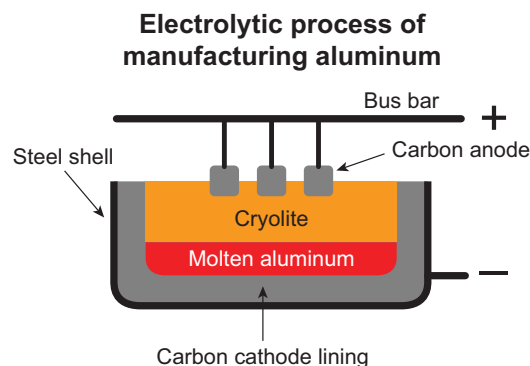

Figure 8.10 Hall's Process

Aluminium is deposited at the cathode and oxygen gas is liberated at the anode. Oxygen combines with graphite to form  $\text{CO}_2$ .

### Physical Properties of Aluminium

- It is a silvery white metal
- It has low density (2.7) and it is light
- It is malleable and ductile
- It is a good conductor of heat and electricity.
- Its melting point is  $660^\circ\text{C}$ .
- It can be polished to produce a shiny attractive appearance.

### Chemical Properties of Aluminium

**i. Reaction with air:** It is not affected by dry air. On heating at  $800^\circ\text{C}$ , aluminium burns very brightly forming its oxide and nitride.

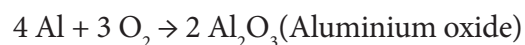

**ii. Reaction with water:** Water does not react with aluminium due to the layer of oxide on it. When steam is passed over red hot aluminium, hydrogen is produced.

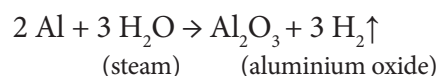

**iii. Reaction with alkalis:** It reacts with strong caustic alkalis forming aluminates.

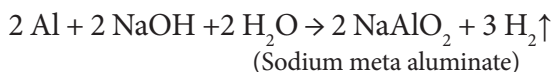

**iv. Reaction with acids:** With dilute and con. HCl it liberates H<sub>2</sub> gas.

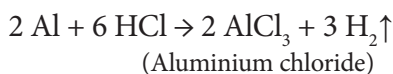

Aluminium liberates hydrogen on reaction with dilute sulphuric acid and liberates sulphur dioxide on reaction with hot concentrated sulphuric acid

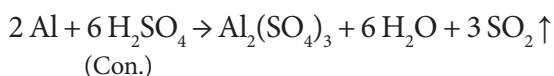
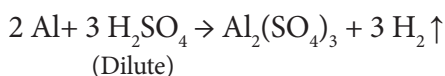

### More to Know

Dilute or concentrated nitric acid does not attack aluminium, but it renders aluminium passive due to the formation of an oxide film on its surface.

**v. As reducing agent:** Aluminium is a powerful reducing agent. When a mixture of aluminium powder and iron oxide is ignited, the latter is reduced to metal. This process is known as **aluminothermic process**.

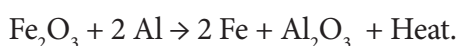

### Uses

Aluminium is used in

- household utensils
- electrical cable industry
- making aeroplanes and other industrial mechine parts

## 8.8 METALLURGY OF COPPER

### Occurrence:

It was named as cuprum by the Romans because they got it from the Island of Cyprus. Copper is found in the native state as well as combined state.

### Ores of copper

Ores of copper	Formula
Copper pyrites	CuFeS <sub>2</sub>
Cuprite or ruby copper	Cu <sub>2</sub> O
Copper glance	Cu <sub>2</sub> S

The chief ore of copper is copper pyrite. It yields nearly 76% of the world production of copper. Extraction of copper from copper pyrites involves the following steps

**i. Concentration of ore:** The ore is crushed and the concentrated by froth floatation process.

**ii. Roasting:** The concentrated ore is roasted in excess of air. During the process of roasting, the moisture and volatile impurities are removed. Sulphur, phosphorus, arsenic and antimony are removed as oxides. Copper pyrite is partly converted into sulphides of copper and iron.



**iii. Smelting:** The roasted ore is mixed with powdered coke and sand and is heated in a blast furnace to obtain matte (Cu<sub>2</sub>S + FeS) and slag. The slag is removed as waste.

**iv. Bessemerisation:** The molten matte is transferred to Bessemer converter in order to obtain blister copper. Ferrous sulphide from matte is oxidized to ferrous oxide, which is removed as slag using silica.

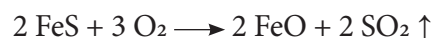

(Iron silicate)

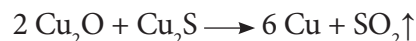
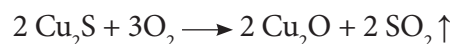

(Blister copper)

**v. Refining:** Blister copper contains 98% of pure copper and 2% of impurities and is purified by **electrolytic refining**. This method is used to get metal of a high degree of purity. For electrolytic refining of copper, we use:

**Cathode:** A thin plate of pure copper metal.

**Anode:** A block of impure copper metal.

**Electrolyte:** Copper sulphate solution acidified with sulphuric acid.

When electric current is passed through the electrolytic solution, pure copper gets deposited at the cathode and the impurities settle at the bottom of the anode in the form of sludge called anode mud.

### Physical Properties of Copper

Copper is a reddish brown metal, with high lustre, high density and high melting point (1356°C).

### Chemical Properties of Copper

**i. Action of Air and Moisture:** Copper gets covered with a green layer of basic copper carbonate in the presence of CO<sub>2</sub> and moisture.



**ii. Action of Heat:** On heating at different temperatures in the presence of oxygen, copper forms two types of oxides CuO and Cu<sub>2</sub>O.

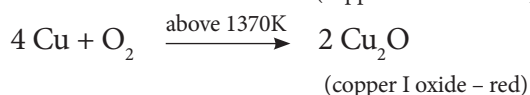
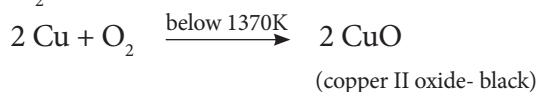

**iii. Action of Acids:**

**a) With dilute HCl and dilute H<sub>2</sub>SO<sub>4</sub>:**

Dilute acids such as HCl and H<sub>2</sub>SO<sub>4</sub> have no action on these metals in the absence of air. Copper dissolves in these acids in the presence of air.



**b) With dil. HNO<sub>3</sub>:**

Copper reacts with dil. HNO<sub>3</sub> with the liberation of Nitric Oxide gas.

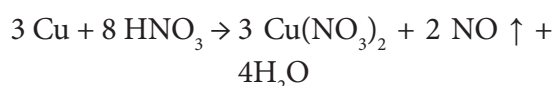

**iv) Action of Chlorine:**

Chlorine reacts with copper, resulting in the formation of copper(II) chloride.

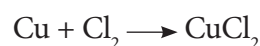

**v) Action of Alkalis:**

Copper is not attacked by alkalis.

### Uses of Copper:

- i. It is extensively used in manufacturing electric cables and other electric appliances.
- ii. It is used for making utensils, containers, calorimeters and coins,
- iii. It is used in electroplating.
- iv. It is alloyed with gold and silver for making coins and jewels

## 8.9 METALLURGY OF IRON

### Occurrence:

Iron is the second most abundant metal available next to aluminium. It occurs in nature as oxides, sulphides and carbonates. The ores of iron are as follows:

Ores of iron	Formula
Haematite	Fe <sub>2</sub> O <sub>3</sub>
Magnetite	Fe <sub>3</sub> O <sub>4</sub>
Iron pyrite	FeS <sub>2</sub>

Iron is chiefly extracted from haematite ore (Fe<sub>2</sub>O<sub>3</sub>)

**i. Concentration by Gravity Separation:** The powdered ore is washed with a steam of water. As a result, the lighter sand particles and other impurities are washed away and the heavier ore particles settle down.

**ii. Roasting and Calcination:** The concentrated ore is strongly heated in a limited supply of air in a reverberatory furnace. As a result, moisture is driven out and sulphur, arsenic and phosphorus impurities are oxidized off.

iii. **Smelting (in a Blast Furnace):** The charge consisting of roasted ore, coke and limestone in the ratio 8:4:1 is smelted in a blast furnace by introducing it through the hopper arrangement at the top. There are three important regions in the furnace.

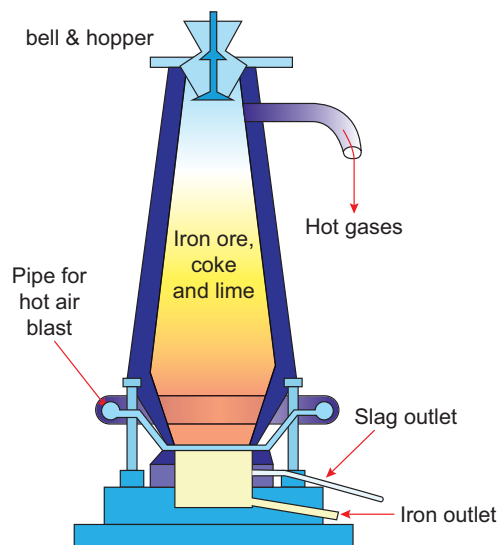
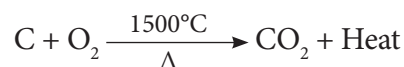

Figure 8.11 Blast Furnace

(a) **The Lower Region (Combustion Zone)-** The temperature is at 1500°C. In this region, coke burns with oxygen to form CO<sub>2</sub> when the charge comes in contact with a hot blast of air.



It is an exothermic reaction since heat is liberated.

(b) **The Middle Region (Fusion Zone) –** The temperature prevails at 1000°C. In this region, CO<sub>2</sub> is reduced to CO.

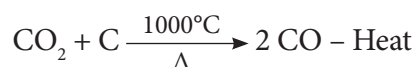

Limestone decomposes to calcium oxide and CO<sub>2</sub>.

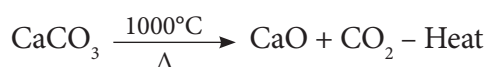

These two reactions are endothermic due to absorption of heat. Calcium oxide combines with silica to form calcium silicate slag.

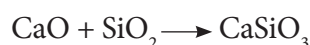

(c) **The Upper Region (Reduction Zone)-** The temperature prevails at 400°C. In this region carbon monoxide reduces ferric oxide to form a fairly pure spongy iron.



The molten iron is collected at the bottom of the furnace after removing the slag.

The iron thus formed is called pig iron. It is remelted and cast into different moulds. This iron is called cast iron.

**Physical properties:**

- i. It is a lustrous metal, greyish white in colour.
- ii. It has high tensility, malleability and ductility.
- iii. It can be magnetized.

**Chemical properties:**

i. **Reaction with air or oxygen:** Only on heating in air, iron forms magnetic oxide.



ii. **Reaction with moist air:** When iron is exposed to moist air, it forms a layer of brown hydrated ferric oxide on its surface. This compound is known as rust and the phenomenon of formation of rust is known as **rusting**.



iii. **Reaction with steam:** When steam is passed over red hot iron, magnetic oxide is formed.

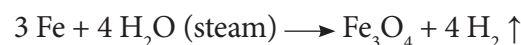

iv. **Reaction with chlorine:** Iron combines with chlorine to form ferric chloride.



v. **Reaction with acids:** With dilute HCl and dilute H<sub>2</sub>SO<sub>4</sub> it liberates H<sub>2</sub> gas.



With dilute HNO<sub>3</sub> in cold condition it gives ferrous nitrate and ammonium nitrate.

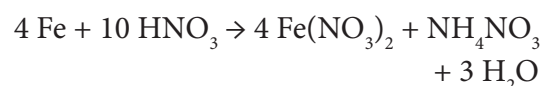

With con.  $H_2SO_4$  it forms ferric sulphate and liberates  $SO_2$ .

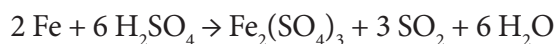

When iron is dipped in con.  $HNO_3$  it becomes chemically passive or inert due to the formation of a layer of iron oxide ( $Fe_3O_4$ ) on its surface.

### Types and uses of iron

**Pig iron** (Iron with 2.0% - 4.5% of carbon): It is used in making pipes, stoves, radiators, railings, manhole covers and drain pipes.

**Steel** (Iron with 0.25% - 2.0% of carbon): It is used in the construction of buildings, machinery, transmission cables and T.V towers and in making alloys.

**Wrought iron** (Iron with < 0.25% of carbon): It is used in making springs, anchors and electromagnets.

## 8.10 ALLOYS

An alloy is a homogeneous mixture of two or more metals or of one or more metals with certain non-metallic elements.

The properties of alloys are often different from those of its components. Pure gold is brittle to be used. The addition of small percentage of copper enhances its strength and utility.

### 8.10.1 Amalgam

An amalgam is an alloy of mercury with another metal. These alloys are formed through metallic bonding with the electrostatic force of attraction between the electrons and the positively charged metal ions. Silver tin amalgam is used for dental filling.

#### Reasons for alloying:

- To modify appearance and colour
- To modify chemical activity.
- To lower the melting point.
- To increase hardness and tensile strength.
- To increase resistance to electricity.

### 8.10.2 Method of making alloys

(a) By fusing the metals together. E.g. Brass is made by melting zinc and copper.

(b) By compressing finely divided metals. E.g. Wood metal: an alloy of lead, tin, bismuth and cadmium powder is a fusible alloy.

#### Alloys as solid solutions:

Alloys can be considered as solid solutions in which the metal with high concentration is solvent and other metals are solute.

For example, brass is a solid solution of zinc (solute) in copper (solvent).

### 8.10.3 Types of Alloys

Based on the presence of Iron, alloys can be classified into:

- Ferrous alloys:** Contain Iron as a major component. A few examples of ferrous alloys are Stainless Steel, Nickel Steel etc.
- Non-ferrous alloys:** These alloys do not contain Iron as a major component. For example, Aluminium alloy, Copper alloy etc.

#### Copper Alloys (Non-ferrous)

Alloys	Uses
Brass (Cu, Zn)	Electrical fittings, medal, decorative items, hardware
Bronze (Cu, Sn)	Statues, coins, bells, gongs

#### Aluminium Alloys (Non-ferrous)

Alloys	Uses
Duralumin (Al, Mg, Mn, Cu)	Aircrafts, tools, pressure cookers
Magnalium (Al, Mg)	Aircraft, scientific instruments

#### Iron Alloys (Ferrous)

Alloys	Uses
Stainless steel (Fe, C, Ni, Cr)	Utensils, cutlery, automobile parts
Nickel steel (Fe, C, Ni)	Cables, aircraft parts, propeller

## 8.11 CORROSION

It is the gradual destruction of metals by chemical or electrochemical reaction with the environment. It is a natural process which converts a metal into its oxide, hydroxide or sulphide so that it loses its metallic characteristics.

### Rusting

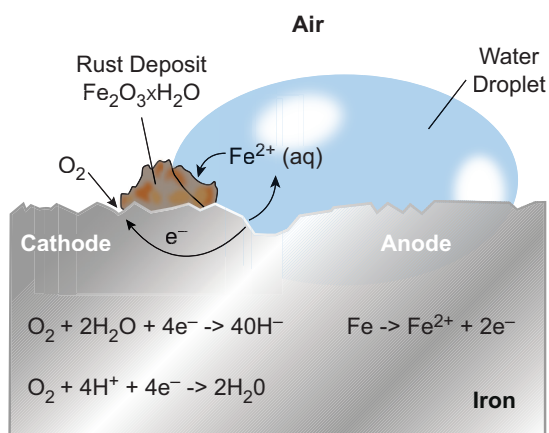

Figure 8.12 Rusting

Rust is chemically known as hydrated ferric oxide (it is formulated as  $Fe_2O_3 \cdot xH_2O$ ). Rusting results in the formation of scaling reddish brown hydrated ferric oxide on the surface of iron and iron containing materials.

### 8.11.1 Types of Corrosion

- i. **Dry Corrosion or Chemical Corrosion:** The corrosive action in the absence of moisture is called dry corrosion. It is the process of a chemical attack on a metal by a corrosive liquids or gases such as  $O_2$ ,  $N_2$ ,  $SO_2$ ,  $H_2S$  etc. It occurs at high temperature. Of all the gases mentioned above  $O_2$  is the most reactive gas to impart the chemical attack.
- ii. **Wet Corrosion or Electrochemical Corrosion:** The corrosive action in the presence of moisture is called wet corrosion. It occurs as a result of electrochemical reaction of metal with water or aqueous solution of salt or acids or bases.

### 8.11.2 Methods of preventing corrosion

- i. **Alloying:** The metals can be alloyed to prevent from the process of corrosion. E.g: Stainless Steel
- ii. **Surface Coating:** It involves application of a protective coating over the metal. It is of the following types:
  - a) **Galvanization:** It is the process of coating zinc on iron sheets by using electric current.
  - b) **Electroplating:** It is a method of coating one metal over another metal by passing electric current.
  - c) **Anodizing:** It is an electrochemical process that converts the metal surface into a decorative, durable and corrosion resistant. Aluminium is widely used for anodizing process.
  - d) **Cathodic Protection:** It is the method of controlling corrosion of a metal surface protected is coated with the metal which is easily corrodible. The easily corrodible metal is called Sacrificial metal to act as anode ensuring cathodic protection.

## 8.12 PAMBAN BRIDGE

It is a railway bridge which connects the town of Rameshwaram on Pamban Island to mainland India. Opened on 1914, it was India's first sea bridge in India until the opening of the BandraWorli Sea Link in 2010. We can control the corrosion and renovation of historical pamban bridge by a periodical protective coating which will be the strong example for applied chemistry to uphold our history.



Figure 8.12 Pamban Bridge



## Points to Remember

- ❖ Modern periodic law states that, the physical and chemical properties of the elements are the periodic functions of their atomic numbers.
- ❖ The table in which elements are arranged in rows and columns in regular gradation is called periodic table.
- ❖ Smelting is the process of reducing the roasted metallic oxide into metal in molten condition.
- ❖ Dilute or con.  $\text{HNO}_3$  does not attack aluminium metal, as it renders aluminium passive due to oxide film formation on its surface.
- ❖ The charge used in the metallurgy of iron consists of roasted ore, coke and limestone in the ratio, 8:4:1.
- ❖ Copper vessel on exposure to air and moisture forms a green layer on its surface due to basic copper carbonate.
- ❖ An alloy is a homogeneous mixture of two or more metals.
- ❖ An amalgam is an alloy of mercury with another metal. E.g. Ag-Sn amalgam is used for dental filling.
- ❖ The chemical name of rust is hydrated ferric oxide and its formula is  $\text{Fe}_2\text{O}_3 \cdot x\text{H}_2\text{O}$ .



## TEXTBOOK EVALUATION



## I. Choose the best answer.

1. The number of periods and groups in the periodic table are \_\_\_\_\_.
  - a) 6,16
  - b) 7,17
  - c) 8,18
  - d) 7,18
2. The basis of modern periodic law is \_\_\_\_\_.
  - a) atomic number
  - b) atomic mass
  - c) isotopic mass
  - d) number of neutrons
3. \_\_\_\_\_ group contains the member of halogen family.
  - a) 17<sup>th</sup>
  - b) 15<sup>th</sup>
  - c) 18<sup>th</sup>
  - d) 16<sup>th</sup>
4. \_\_\_\_\_ is a relative periodic property
  - a) atomic radii
  - b) ionic radii
  - c) electron affinity
  - d) electronegativity
5. Chemical formula of rust is \_\_\_\_\_.
  - a)  $\text{FeO} \cdot x\text{H}_2\text{O}$
  - b)  $\text{FeO}_4 \cdot x\text{H}_2\text{O}$
  - c)  $\text{Fe}_2\text{O}_3 \cdot x\text{H}_2\text{O}$
  - d)  $\text{FeO}$
6. In the alumino thermic process the role of Al is \_\_\_\_\_.
  - a) oxidizing agent
  - b) reducing agent
  - c) hydrogenating agent
  - d) sulphurising agent
7. The process of coating the surface of metal with a thin layer of zinc is called \_\_\_\_\_.
  - a) painting
  - b) thinning
  - c) galvanization
  - d) electroplating
8. Which of the following have inert gases 2 electrons in the outermost shell.
  - a) He
  - b) Ne
  - c) Ar
  - d) Kr

9. Neon shows zero electron affinity due to \_\_\_\_\_.
- stable arrangement of neutrons
  - stable configuration of electrons
  - reduced size
  - increased density
10. \_\_\_\_\_ is an important metal to form amalgam.
- Ag
  - Hg
  - Mg
  - Al

**II. Fill in the blanks**

- If the electronegativity difference between two bonded atoms in a molecule is greater than 1.7, the nature of bonding is \_\_\_\_\_.
- \_\_\_\_\_ is the longest period in the periodical table.
- \_\_\_\_\_ forms the basis of modern periodic table.
- If the distance between two Cl atoms in Cl<sub>2</sub> molecule is 1.98Å, then the radius of Cl atom is \_\_\_\_\_.
- Among the given species A<sup>-</sup>, A<sup>+</sup>, and A, the smallest one in size is \_\_\_\_\_.
- The scientist who propounded the modern periodic law is \_\_\_\_\_.
- Across the period, ionic radii \_\_\_\_\_ (increases, decreases).
- \_\_\_\_\_ and \_\_\_\_\_ are called inner transition elements.
- The chief ore of Aluminium is \_\_\_\_\_.
- The chemical name of rust is \_\_\_\_\_.

**III. Match the following**

- |                      |   |                               |
|----------------------|---|-------------------------------|
| 1. Galvanisation     | - | Noble gas elements            |
| 2. Calcination       | - | Coating with Zn               |
| 3. Redox reaction    | - | Silver-tin amalgam            |
| 4. Dental filling    | - | Alumino thermic process       |
| 5. Group 18 elements | - | Heating in the absence of air |

**IV. True or False: (If false give the correct statement)**

- Moseley's periodic table is based on atomic mass.
- Ionic radius increases across the period from left to right.
- All ores are minerals; but all minerals cannot be called as ores;
- Al wires are used as electric cables due to their silvery white colour.
- An alloy is a heterogenous mixture of metals.

**V. Assertion and Reason**

**Answer the following questions using the data given below:**

- A and R are correct, R explains the A.
- A is correct, R is wrong.
- A is wrong, R is correct.
- A and R are correct, R doesn't explain A.

- Assertion :** The nature of bond in HF molecule is ionic

**Reason :** The electronegativity difference between H and F is 1.9

- Assertion :** Magnesium is used to protect steel from rusting

**Reason :** Magnesium is more reactive than iron

- Assertion :** An uncleaned copper vessel is covered with greenish layer.

**Reason :** copper is not attacked by alkali

**VI. Short answer questions**

- A is a reddish brown metal, which combines with O<sub>2</sub> at < 1370 K gives B, a black coloured compound. At a temperature > 1370 K, A gives C which is red in colour. Find A, B and C with reaction.
- A is a silvery white metal. A combines with O<sub>2</sub> to form B at 800°C, the alloy of A is used in making the aircraft. Find A and B
- What is rust? Give the equation for formation of rust.
- State two conditions necessary for rusting of iron.

**VII. Long answer questions**

- State the reason for addition of caustic alkali to bauxite ore during purification of bauxite.
  - Along with cryolite and alumina, another substance is added to the electrolyte mixture. Name the substance and give one reason for the addition.
- The electronic configuration of metal A is 2,8,18,1.  
The metal A when exposed to air and moisture forms B a green layered compound. A with con.  $H_2SO_4$  forms C and D along with water. D is a gaseous compound. Find A,B,C and D.
- Explain smelting process.

**VIII. HOT questions**

- Metal A belongs to period 3 and group 13. A in red hot condition reacts with steam to form B. A with strong alkali forms C. Find A,B and C with reactions

- Name the acid that renders aluminium passive. Why?
- Identify the bond between H and F in HF molecule.
  - What property forms the basis of identification?
  - How does the property vary in periods and in groups?



**REFERENCE BOOKS**

- Inorganic chemistry by PL Soni
- Physical chemistry by Puri and Sharma
- Inorganic chemistry by Atkins
- Oxford Inorganic chemistry



**INTERNET RESOURCES**

- <https://www.webelements.com>
- [www.rsc.orgperiodic-table](http://www.rsc.orgperiodic-table)
- <https://www.tcyonline.com>

**CONCEPT MAP**

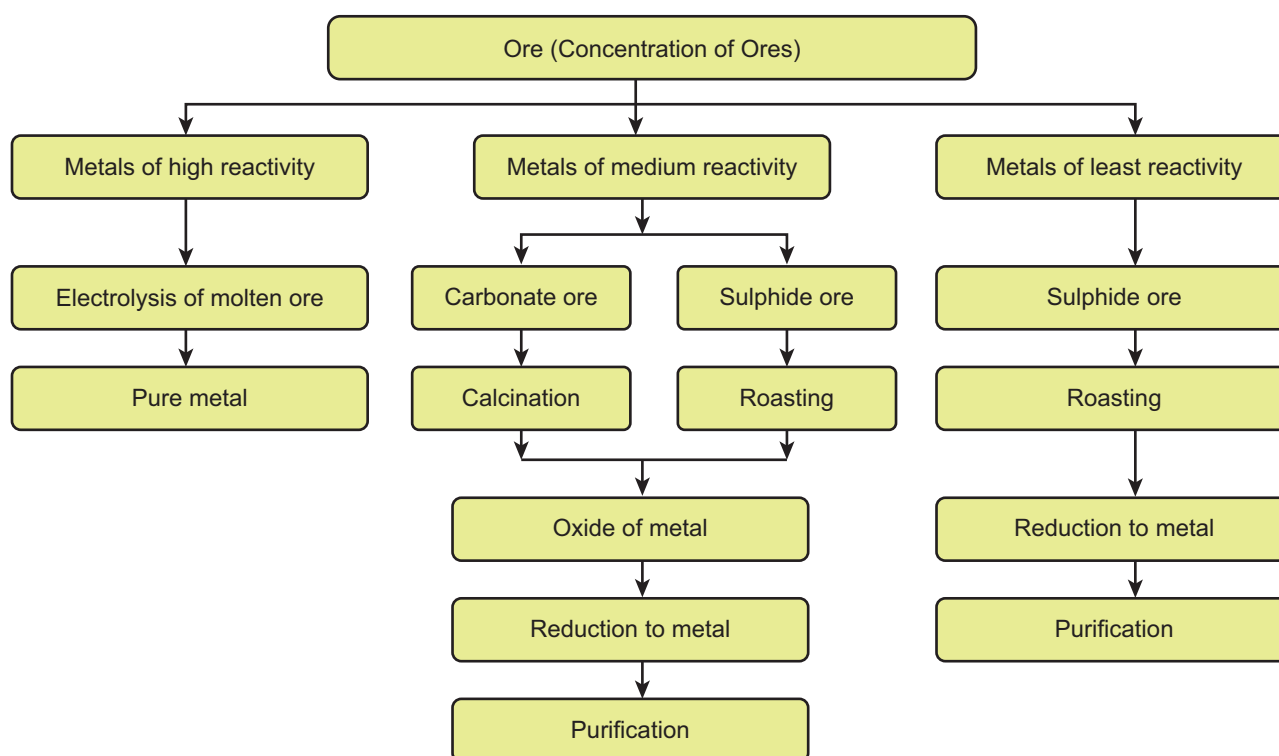

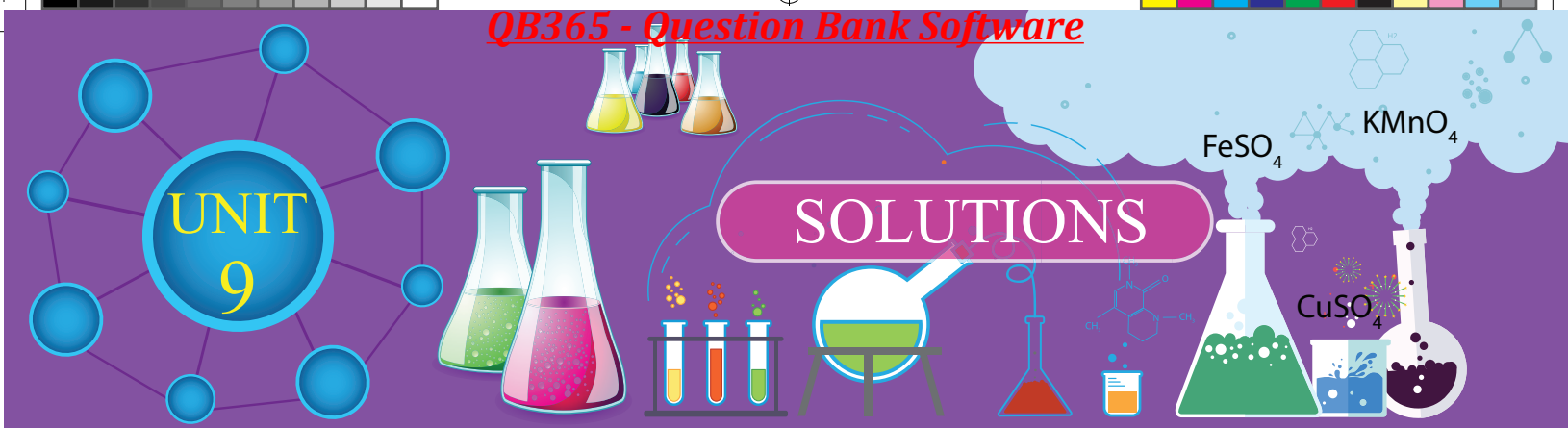

## Learning Objectives

After studying this lesson, students will be able to

- ◆ define solution.
- ◆ recognize the types of solutions.
- ◆ analyse the factors influencing solubility.
- ◆ explain the various modes of expression of concentration of solution.
- ◆ calculate the solubility of solutes in solvents.
- ◆ correlate the hydrated salts and anhydrous salts.
- ◆ distinguish between deliquescent and hygroscopic substances.



## INTRODUCTION

You have learnt about mixtures in your lower classes. Most of the substances that we encounter in our daily life are mixtures of two or more substances. The substances present in a mixture may exist in one or more physical state. For example, when we burn wood, the smoke released is a mixture of solid carbon and gases like  $\text{CO}_2$ ,  $\text{CO}$ , etc.

In some cases of mixtures, their components can be separated easily whereas in some other cases they cannot be. Consider the two mixtures, one which contains salt and water, and the another which contains sand and water. Water is the one of the components in both the mixtures. In the first case salt dissolves in water. In the second case the sand does not dissolve in water. Sand in water can be separated by filtration but salt cannot be separated as it dissolves in water to form a homogeneous

mixture. This kind of homogeneous mixtures are termed as “**solutions**”.

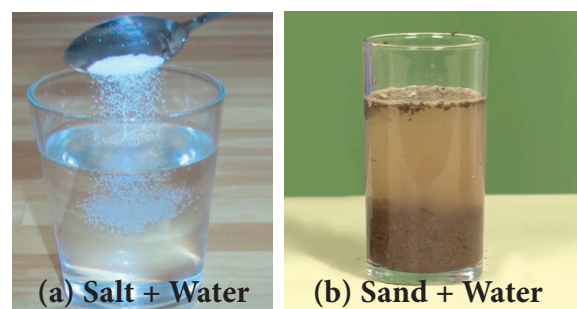

**Figure 9.1** a) Homogeneous mixture  
b) heterogeneous mixture

## 9.1 SOLUTIONS IN DAY-TO-DAY LIFE

One of the naturally existing solutions is sea water. We cannot imagine life on earth without sea water. It is a mixture of many dissolved salts. The another one is air. It is a mixture of gases like nitrogen, oxygen, carbon dioxide and other gases.

All the life forms on the earth are associated with solutions. Plants take solutions of nutrients for their growth from the soil. Most of the liquids found in human body including blood, lymph and urine are solutions. Day to day human activities like washing, cooking, cleaning and few other activities involve the formation of solutions with water. Similarly, the drinks what we take, like fruit juice, aerated drinks, tea, coffee etc. are also solutions. Therefore, the ability of water to form solutions is responsible for sustenance of life.

## 9.2 COMPONENTS OF SOLUTIONS

We know that, a **solution is a homogeneous mixture of two or more substances**. In a solution, the component which is present in lesser amount (by weight), is called **solute** and the component, which is present in a larger amount (by weight) is called **solvent**. The solute gets distributed uniformly throughout the solvent and thus forming the mixture homogeneous. So, the solvent acts as a dissolving medium in a solution. The process of uniform distribution of solute into solvent is called **dissolution**. Figure 9.2 shows the schematic representation of solution.

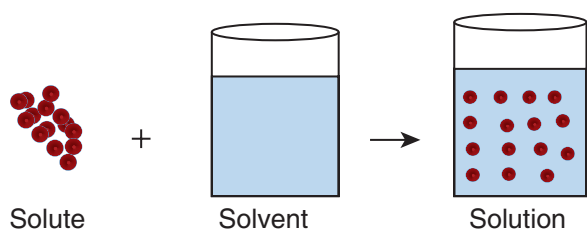
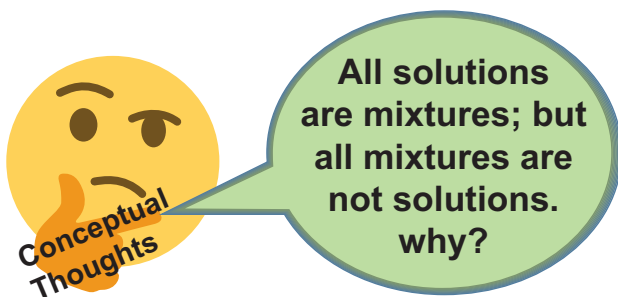

Figure 9.2 Formation of solution



A solution must at least be consisting of two components (a solute and a solvent). Such solutions which are made of one solute and one solvent (two components) are called **binary solutions**. e.g. On adding copper sulphate crystals to water, it dissolves in water forming a solution of copper sulphate as shown in Figure 9.3. It contains two components i.e. one solute- copper sulphate and one solvent-water. So it is a binary solution. Similarly, a solution may contain more than two components. For example if salt and sugar are added to water, both dissolve in water forming a solution. Here two solutes are dissolved in one solvent. Such kind of solutions which contain three components are called **ternary solutions**.



Figure 9.3 Formation of Copper sulphate solution

## 9.3 Types of Solutions

### 9.3.1 Based on the physical state of the solute and the solvent

We know that substances normally exist in three physical states (phases) i.e., solid, liquid and gas. In binary solutions, both the solvent and solute may exist in any of these physical states. But the solvent constitutes the major part of the solution. Its physical state is the primary factor which determine the characteristics of the solution. Therefore, there are different types of binary solutions as listed in Table 9.1.

**Table 9.1** Types of binary solutions

Solute	Solvent	Example
<b>Solid solution</b>		
Solid	Solid	Copper dissolved in gold (Alloys)
Liquid	Solid	Mercury with sodium (amalgam)
<b>Liquid solution</b>		
Solid	Liquid	Sodium chloride dissolved in water
Liquid	Liquid	Ethyl alcohol dissolved in water
Gas	Liquid	carbon-di-oxide dissolved in water (Soda water)
<b>Gaseous solution</b>		
Liquid	Gas	Water vapour in air (cloud)
Gas	Gas	Mixture of Helium-Oxygen gases,

### 9.3.2 Based on the type of solvent

Most of the substances are soluble in water. That is why, water is called as ‘Universal solvent’. However some substances do not dissolve in water. Therefore, other solvents such as ethers, benzene, alcohols etc., are used to prepare a solution. On the basis of type of solvent, solutions are classified into two types. They are aqueous solutions and non-aqueous solutions.

#### a) Aqueous solution:

The solution in which water acts as a solvent is called aqueous solution. E.g. Common salt in water, Sugar in water, Copper sulphate in water etc.

#### b) Non – Aqueous solution:

The solution in which any liquid, other than water, acts as a solvent is called non-aqueous solution. Solvent other than water is referred to as non-aqueous solvent. Generally, alcohols, benzene, ethers, carbon disulphide, acetone, etc., are used as non-aqueous solvents. Examples for non-aqueous solutions: Sulphur dissolved in carbon disulphide, Iodine dissolved in carbon tetrachloride.

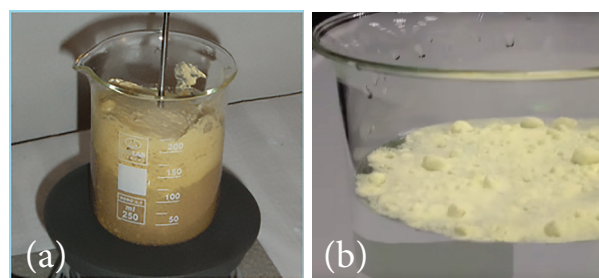

**Figure 9.4** a) Sulphur is soluble in CS<sub>2</sub>  
b) Sulphur is insoluble in water

### 9.3.3 Based on the amount of solute

The amount of the solute that can be dissolved in the given amount of solvent is limited under any given conditions. Based on the amount of solute, in the given amount of solvent, solutions are classified into the following types:

- (i) Saturated solution
- (ii) Unsaturated solution
- (iii) Super saturated solution

**(i) Saturated solution:** A solution in which no more solute can be dissolved in a definite amount of the solvent at a given temperature is called saturated solution. e.g. 36 g of sodium chloride in 100 g of water at 25°C forms saturated solution.

Further addition of sodium chloride, leave it undissolved.

(ii) **Unsaturated solution:** Unsaturated solution is one that contains less solute than that of the saturated solution at a given temperature. e.g. 10 g or 20 g or 30 g of Sodium chloride in 100 g of water at 25°C forms an unsaturated solution.

(iii) **Super saturated solution:** Supersaturated solution is one that contains more solute than the saturated solution at a given temperature. e.g. 40 g of sodium chloride in 100 g of water at 25°C forms super saturated solution. This state can be achieved by altering any other conditions like temperature, pressure. Super saturated solutions are unstable, and the solute is reappearing as crystals when the solution is disturbed.

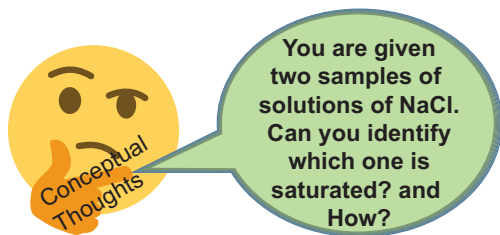

### 9.3.4 Concentrated and dilute solutions

It is another kind of classification of unsaturated solutions. It expresses the relative concentration of two solutions with respect to their solutes present in the given amount of the solvent. For example, you are given two cups of tea. When you taste them, you feel that one is sweeter than the other. What do you infer from it? The tea which is sweeter contains a higher amount of sugar than the other. How can you express your observation? You can say that the tea is stronger. But a chemist would say that it is 'concentrated'.

When we compare two solutions having same solute and solvent, the one which contains a higher amount of solute per the given amount of solvent is said to be '**concentrated solution**'

and the other is said to be '**dilute solution**'. They are schematically represented by Figure 9.5.

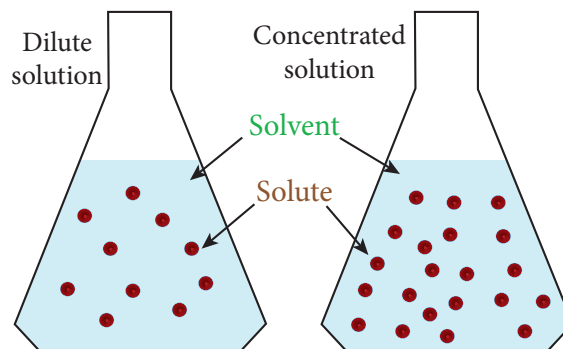

Figure 9.5 Dilute and Concentrated Solution

Differentiating solutions as dilute and concentrated is a qualitative representation. It does not imply the quantity of the solute. This difference is observed by means of some physical characteristics such as colour, density, etc.

### Activity 1

Look at the following pictures. Label them as dilute and concentrated solution and justify your answer.



Tea

Copper sulphate

### 9.4 Solubility

Usually, there is a limit to the amount of solute that can be dissolved in a given amount of solvent at a given temperature. When this limit is reached, we have a saturated solution and any excess solute that is added, simply settles down at the bottom of the solution. The extent of dissolution of a solute in a solvent can be better explained by its solubility. Solubility is a measure of how much of a solute can be dissolved in a specified amount of a solvent.

**Solubility** is defined as the number of grams of a solute that can be dissolved in 100 g of a solvent to form its saturated solution at a given temperature and pressure. For example, 36 g of sodium chloride need to be dissolved in 100 g of water to form its saturated solution at 25°C. Thus the solubility of NaCl in water is 36 g at 25°C. The solubility is mathematically expressed as

$$\text{Solubility} = \frac{\text{Mass of the solute}}{\text{Mass of the solvent}} \times 100$$

**Table 9.2** Solubility's of some common substances in water at 25°C

Name of the solute	Formula of the solute	Solubility g/100 g water
Calcium carbonate	CaCO <sub>3</sub> (s)	0.0013
Sodium chloride	NaCl (s)	36
Ammonia	NH <sub>3</sub> (g)	48
Sodium hydroxide	NaOH(s)	80
Glucose	C <sub>6</sub> H <sub>12</sub> O <sub>6</sub> (s)	91
Sodium bromide	NaBr(s)	95
Sodium iodide	NaI(s)	184

### 9.4.1 Factors affecting solubility

There are three main factors which govern the solubility of a solute. They are:

- (i) Nature of the solute and solvent
- (ii) Temperature
- (iii) Pressure



#### (i) Nature of the solute and solvent

The nature of the solute and solvent plays an important role in solubility. Although water dissolves an enormous variety of substances, both ionic and covalent, it does not dissolve everything. The phrase that scientists often use when predicting solubility is “like dissolves

like.” This expression means that dissolving occurs when similarities exist between the solvent and the solute. For example: Common salt is a polar compound and dissolves readily in polar solvent like water.

Non-polar compounds are soluble in non-polar solvents. For example, Fat dissolved in ether. But non-polar compounds, do not dissolve in polar solvents; polar compounds do not dissolve in non-polar solvents.

#### (ii) Effect of Temperature

##### Solubility of Solids in Liquid:

Generally, solubility of a solid solute in a liquid solvent increases with increase in temperature. For example, a greater amount of sugar will dissolve in warm water than in cold water.

In endothermic process, solubility increases with increase in temperature.

In exothermic process, solubility decreases with increase in temperature.

##### Solubility of Gases in liquid

Do you know why is it bubbling when water is boiled? Solubility of gases in liquid decrease with increase in temperature. Generally, water contains dissolved oxygen. When water is heated, the solubility of oxygen in water decreases, so oxygen escapes in the form of bubbles.

Aquatic animals live more in cold regions because, more amount of dissolved oxygen is present in the water of cold regions. This shows that the solubility of oxygen in water is more at low temperatures.

#### (iii) Effect of Pressure

Effect of pressure is observed only in the case of solubility of a gas in a liquid. When the pressure is increased, the solubility of a gas in liquid increases.

The common examples for solubility of gases in liquids are carbonated beverages, i.e. soft drinks, household cleaners containing



aqueous solution of ammonia, formalin-aqueous solution of formaldehyde, etc.

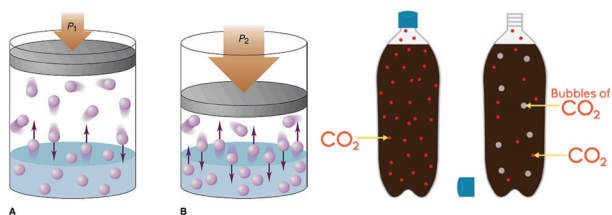

Figure 9.6 Effect of pressure on solubility

### More to know

The effect of pressure on the solubility of a gas in liquid is given by **Henry's law**. It states that, the solubility of a gas in a liquid is directly proportional to the pressure of the gas over the solution at a definite temperature.

## 9.5 Concentration of a Solution

So far, we discussed what is a solution? what does it consist of and its types. Most of the chemical reactions take place in solutions form. So it is essential to quantify the solute in solvent to study the reactions. To quantify the solute in a solution, we can use the term “**concentration**”.

**Concentration of a solution may be defined as the amount of solute present in a given amount of solution or solvent.**

Quantitatively, concentration of a solution may be expressed in different methods. But here, we shall discuss percentage by mass (% mass) and percentage by volume (% volume).

### 9.5.1 Mass percentage

Mass percentage of a solution is defined as the percentage by mass of the solute present in the solution. It is mostly used when solute is solid and solvent is liquid.

$$\text{Mass Percentage} = \frac{\text{Mass of the solute}}{\text{Mass of the solution}} \times 100$$

$$\text{Mass Percentage} = \frac{\text{Mass of the solute}}{\text{Mass of the solute} + \text{Mass of the solvent}} \times 100$$

For example: 5% sugar solution (by mass) means 5 g of sugar in 95 g of water. Hence it is made 100g of solution.

Usually, mass percentage is expressed as w/w (weight / weight); mass percentage is independent of temperature.

### 9.5.2 Volume percentage

Volume percentage is defined as the percentage by volume of solute (in ml) present in the given volume of the solution.

$$\text{Volume Percentage} = \frac{\text{Volume of the solute}}{\text{Volume of the solution}} \times 100$$

$$\text{Volume Percentage} = \frac{\text{Volume of the solute}}{\text{Volume of the solute} + \text{volume of the solvent}} \times 100$$

For example, 10% by volume of the solution of ethanol in water, means 10 ml of ethanol in 100 ml of solution (or 90 ml of water)

Usually volume percentage is expressed as v/v (volume / volume). It is used when both the solute and solvent are liquids. Volume percentage decreases with increases in temperature, because of expansion of liquid.

You can notice that in the commercial products that we come across in our daily life such as a solution of syrups, mouth wash, antiseptic solution, household disinfectants etc., the concentration of the ingredients is expressed as v/v. Similarly, in ointments, antacid, soaps, etc., the concentration of solutions are expressed as w/w.

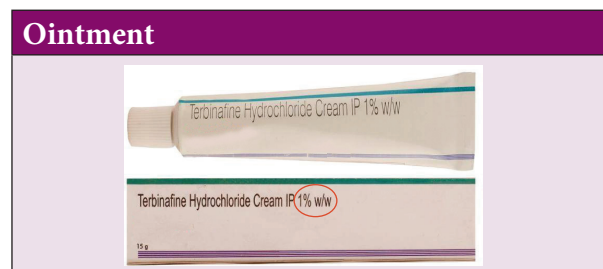

Figure 9.7 Ointment (w/w percent)

## 9.6 Hydrated salts and Water of Crystallization

When ionic substances are dissolved in water to make their saturated aqueous solution, their ions attract water molecules which then attached chemically in certain ratio. This process is called hydration. These ionic substances crystallize out from their saturated aqueous solution with a definite number of molecules of water. The number of water molecules found in the crystalline substance is called **water of crystallization**. Such salts are called hydrated salts.



**Figure 9.8** a) Crystalline hydrated salt  
b) Amorphous anhydrous salt

On heating these hydrated crystalline salts, they lose their water of crystallization and become amorphous or lose their colour (if they are coloured). Table 9.3 shows some common hydrated salts:

**Table 9.3** Hydrated salts

Common Name	IUPAC Name	Molecular Formula
Blue Vitriol	Copper (II) sulphate pentahydrate	$\text{CuSO}_4 \cdot 5\text{H}_2\text{O}$
Epsom Salt	Magnesium sulphate heptahydrate	$\text{MgSO}_4 \cdot 7\text{H}_2\text{O}$
Gypsum	Calcium sulphate dihydrate	$\text{CaSO}_4 \cdot 2\text{H}_2\text{O}$
Green Vitriol	Iron (II) sulphate heptahydrate	$\text{FeSO}_4 \cdot 7\text{H}_2\text{O}$
White Vitriol	Zinc sulphate heptahydrate	$\text{ZnSO}_4 \cdot 7\text{H}_2\text{O}$

### 9.6.1 Copper sulphate pentahydrate $\text{CuSO}_4 \cdot 5\text{H}_2\text{O}$ (Blue vitriol)

The number of water molecules in blue vitriol is five. So its water of crystallization is 5. When blue coloured copper sulphate crystals are gently heated, it loses its five water molecules and becomes colourless anhydrous copper sulphate.

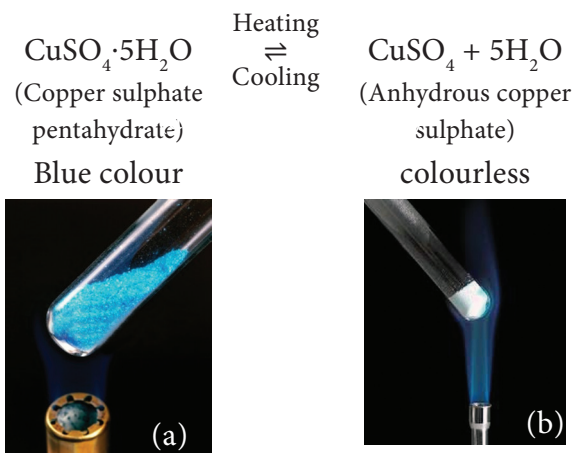

**Figure 9.9** a) Copper sulphate before heating  
b) Copper sulphate after heating

If you add few drops of water or allow it to cool, the colourless anhydrous salt again turns back into blue coloured hydrated salt.

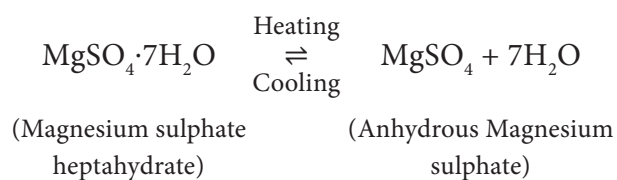

**Figure 9.10** Anhydrous copper sulphate turns to blue when water is added

### 9.6.2 Magnesium sulphate heptahydrate $\text{MgSO}_4 \cdot 7\text{H}_2\text{O}$ (Epsom salt)

Its water of crystallization is 7. When magnesium sulphate heptahydrate crystals are

gently heated, it loses seven water molecules, and becomes anhydrous magnesium sulphate.



If you add few drops of water or allow it to cool, the colourless anhydrous salt again turns back into hydrated salt.

### 9.7 Hygroscopy

Certain substances, when exposed to the atmospheric air at ordinary temperature, absorb moisture without changing their physical state. Such substances are called **hygroscopic substances** and this property is called hygroscopy.

Hygroscopic substances are used as drying agents.

- Example:**
1. Conc. Sulphuric acid ( $\text{H}_2\text{SO}_4$ ).
  2. Phosphorus Pentoxide ( $\text{P}_2\text{O}_5$ ).
  3. Quick lime ( $\text{CaO}$ ).
  4. Silica gel ( $\text{SiO}_2$ ).

### 9.8 Deliquescence

Certain substances which are so hygroscopic, when exposed to the atmospheric air at ordinary temperatures, absorb enough

water and get completely dissolved. Such substances are called **deliquescent substances** and this property is called **deliquescence**.

Deliquescent substances lose their crystalline shape and ultimately dissolve in the absorbed water forming a saturated solution.

Deliquescence is maximum when:

- 1) The temperature is low
- 2) The atmosphere is humid

**Examples:** Caustic soda ( $\text{NaOH}$ ), Caustic potash ( $\text{KOH}$ ) and Ferric chloride ( $\text{FeCl}_3$ ).



Figure 9.11 Deliquescence in Sodium hydroxide

### 9.9 Problems Based on Solubility and Percentage by Mass and Volume

#### I. Problems based on solubility

- 1) 1.5 g of solute is dissolved in 15 g of water to form a saturated solution at 298K. Find out the solubility of the solute at the temperature.

Table 9.3 Difference between hygroscopic substances and deliquescence.

Hygroscopic substances	Deliquescence substances
When exposed to the atmosphere at ordinary temperature, they absorb moisture and do not dissolve.	When exposed to the atmospheric air at ordinary temperature, they absorb moisture and dissolve.
Hygroscopic substances do not change its physical state on exposure to air.	Deliquescent substances change its physical state on exposure to air.
Hygroscopic substances may be amorphous solids or liquids.	Deliquescent substances are crystalline solids.

Mass of the solute = 1.5 g

Mass of the solvent = 15 g

$$\text{Solubility of the solute} = \frac{\text{Mass of the solute}}{\text{Mass of the solvent}} \times 100$$

$$\begin{aligned} \text{Solubility of the solute} &= \frac{1.5}{15} \times 100 \\ &= 10 \text{ g} \end{aligned}$$

- 2) Find the mass of potassium chloride would be needed to form a saturated solution in 60 g of water at 303 K? Given that solubility of the KCl is 37/100 g at this temperature.

Mass of potassium chloride in 100 g of water in saturated solution = 37 g

$$\begin{aligned} \text{Mass of potassium chloride in} \\ \text{60 g of water in saturated solution} &= \frac{37}{100} \times 60 \\ &= 22.2 \text{ g} \end{aligned}$$

- 3) What is the mass of sodium chloride that would be needed to form a saturated solution in 50 g of water at 30°C. Solubility of sodium chloride is 36 g at 30°C?

At 30°C, 36 g of sodium chloride is dissolved in 100 g of water.

∴ Mass of sodium chloride that would be need for 100 g of water = 36 g

$$\begin{aligned} \therefore \text{Mass of sodium chloride} \\ \text{dissolved in 50 g of water} &= \frac{36 \times 50}{100} \\ &= 18 \text{ g} \end{aligned}$$

- 4) The solubility of sodium nitrate at 50°C and 30°C is 114 g and 96 g respectively. Find the amount of salt that will be thrown out when a saturated solution of sodium nitrate containing 50 g of water is cooled from 50°C to 30°C?

Amount of sodium nitrate dissolved in 100 g of water at 50°C is 114 g

$$\begin{aligned} \therefore \text{Amount of sodium nitrate} \\ \text{dissolving in 50 g of water at 50°C is} &= \frac{114 \times 50}{100} \\ &= 57 \text{ g} \end{aligned}$$

$$\begin{aligned} \text{Similarly amount of sodium nitrate} \\ \text{dissolving in 50g of water at 30°C is} &= \frac{96 \times 50}{100} \\ &= 48 \text{g} \end{aligned}$$

Amount of sodium nitrate thrown when 50g of water is cooled from 50°C to 30°C is

$$57 - 48 = 9 \text{ g}$$

### II. Problem based on mass percentage

- 1) A solution was prepared by dissolving 25 g of sugar in 100 g of water. Calculate the mass percentage of solute.

Mass of the solute = 25 g

Mass of the solvent = 100 g

$$\text{Mass Percentage} = \frac{\text{Mass of the solute}}{\text{Mass of the solution}} \times 100$$

$$\begin{aligned} \text{Mass Percentage} &= \frac{\text{Mass of the solute}}{\text{Mass of the solute} + \text{Mass of the solvent}} \times 100 \\ &= \frac{25}{25+100} \times 100 \end{aligned}$$

$$= \frac{25}{125} \times 100$$

$$= 20\%$$

- 2) 16 grams of NaOH is dissolved in 100 grams of water at 25°C to form a saturated solution. Find the mass percentage of solute and solvent.

Mass of the solute (NaOH) = 16 g

Mass of the solvent H<sub>2</sub>O = 100 g

#### (i) Mass percentage of the solute

$$\begin{aligned} \text{Mass percentage of solute} &= \frac{\text{Mass of the solute}}{\text{Mass of the solute} + \text{Mass of the solvent}} \times 100 \\ &= \frac{16 \times 100}{16 + 100} \end{aligned}$$

$$= \frac{1600}{116}$$

$$= 13.79\%$$

Mass percentage of the solute = 13.79 %

$$\begin{aligned} \text{(ii) Mass percentage of solvent} &= 100 \\ &- (\text{Mass percentage of the solute}) \\ &= 100 - 13.79 \\ &= 86.21\% \end{aligned}$$

3) Find the amount of urea which is to be dissolved in water to get 500 g of 10% w/w aqueous solution?

$$\text{Mass percentage (w/w)} = \frac{\text{Mass of the solute}}{\text{Mass of the solution}} \times 100$$

$$10 = \frac{\text{Mass of the urea}}{500} \times 100$$

Mass of urea = 50g

**(iii) Problem based on volume - volume percentage.**

1) A solution is made from 35 ml of Methanol and 65 ml of water. Calculate the volume percentage.

Volume of the ethanol = 35 ml

Volume of the water = 65 ml

$$\text{Volume percentage} = \frac{\text{Volume of the solute}}{\text{Volume of the solution}} \times 100$$

$$\text{Volume percentage} = \frac{\text{Volume of the solute}}{\text{Volume of the solute} + \text{Volume of the solvent}} \times 100$$

$$\text{Volume percentage} = \frac{35}{35+65} \times 100$$

$$\begin{aligned} \text{Volume percentage} &= \frac{35}{100} \times 100 \\ &= 35\% \end{aligned}$$

2) Calculate the volume of ethanol in 200 ml solution of 20% v/v aqueous solution of ethanol.

Volume of aqueous solution = 200 ml

Volume percentage = 20%

$$\text{Volume percentage} = \frac{\text{Volume of solute}}{\text{Volume of solution}} \times 100$$

$$20 = \frac{\text{Volume of ethanol}}{200} \times 100$$

$$\text{Volume of ethanol} = \frac{20 \times 200}{100} = 40 \text{ ml}$$

#### Points to Remember

- ❖ A solution is a homogeneous mixture of two or more substances.
- ❖ An aqueous solution is a solution in which the solvent is water.
- ❖ A non-aqueous solution is a solution in which the solvent is a liquid, other than water
- ❖ A solution in which no more solute can be dissolved in a definite amount of the solvent at a given temperature is called saturated solution.
- ❖ An unsaturated solution is one that contains less solute than the saturated solution at a given temperature.
- ❖ A supersaturated solution is one that contains more solute than the saturated solution at a given temperature.
- ❖ Polar compounds are soluble in polar solvents.
- ❖ Non-polar compounds are soluble in non-polar solvents.
- ❖ In endothermic process, solubility of solid solute increases with increase in temperature.
- ❖ In exothermic process, solubility of solid solute decreases with increase in temperature.



## TEXTBOOK EVALUATION



### I. Choose the correct answer.

- A solution is a \_\_\_\_\_ mixture.
  - homogeneous
  - heterogeneous
  - homogeneous and heterogeneous
  - non homogeneous
- The number of components in a binary solution is \_\_\_\_\_.
  - 2
  - 3
  - 4
  - 5
- Which of the following is the universal solvent?
  - Acetone
  - Benzene
  - Water
  - Alcohol
- A solution in which no more solute can be dissolved in a definite amount of solvent at a given temperature is called \_\_\_\_\_.
  - Saturated solution
  - Un saturated solution
  - Super saturated solution
  - Dilute solution
- Identify the non aqueous solution.
  - sodium chloride in water
  - glucose in water
  - copper sulphate in water
  - sulphur in carbon-di-sulphide
- When pressure is increased at constant temperature the solubility of gases in liquid \_\_\_\_\_.
  - No change
  - increases
  - decreases
  - no reaction
- Solubility of NaCl in 100 ml water is 36 g. If 25 g of salt is dissolved in 100 ml of water how much more salt is required for saturation \_\_\_\_\_.
  - 12g
  - 11g
  - 16g
  - 20g
- A 25% alcohol solution means
  - 25 ml alcohol in 100 ml of water
  - 25 ml alcohol in 25 ml of water
  - 25 ml alcohol in 75 ml of water
  - 75 ml alcohol in 25 ml of water
- Deliquescence is due to \_\_\_\_\_.
  - Strong affinity to water
  - Less affinity to water
  - Strong hatred to water
  - Inertness to water
- Which of the following is hygroscopic in nature?
  - ferric chloride
  - copper sulphate penta hydrate
  - silica gel
  - none of the above

### II. Fill in the blanks

- The component present in lesser amount, in a solution is called \_\_\_\_\_.
- Example for liquid in solid type solution is \_\_\_\_\_.
- Solubility is the amount of solute dissolved in \_\_\_\_\_ g of solvent.
- Polar compounds are soluble in \_\_\_\_\_ solvents
- Volume percentage decreases with increases in temperature because \_\_\_\_\_.

### III. Match the following

- |                  |   |
|------------------|---|
| 1. Blue vitriol  | - $\text{CaSO}_4 \cdot 2\text{H}_2\text{O}$ |
| 2. Gypsum        | - CaO                                       |
| 3. Deliquescence | - $\text{CuSO}_4 \cdot 5\text{H}_2\text{O}$ |
| 4. Hygroscopic   | - NaOH                                      |

**IV. True or False: (If false give the correct statement)**

1. Solutions which contain three components are called binary solution.
2. In a solution the component which is present in lesser amount is called solvent.
3. Sodium chloride dissolved in water forms a non-aqueous solution.
4. The molecular formula of green vitriol is  $\text{MgSO}_4 \cdot 7\text{H}_2\text{O}$
5. When Silica gel is kept open, it absorbs moisture from the air, because it is hygroscopic in nature

**V. Short answer**

1. Define the term: Solution
2. What is mean by binary solution
3. Give an example each i) gas in liquid  
ii) solid in liquid iii) solid in solid  
iv) gas in gas
4. What is aqueous and non-aqueous solution? Give an example.
5. Define Volume percentage
6. The aquatic animals live more in cold region Why?
7. Define Hydrated salt.
8. A hot saturated solution of copper sulphate forms crystals as it cools. Why?
9. Classify the following substances into deliquescent, hygroscopic.  
Conc. Sulphuric acid, Copper sulphate penta hydrate, Silica gel, Calcium chloride, and Gypsum salt.

**VI. Long answer:**

1. Write notes on i) saturated solution  
ii) unsaturated solution
2. Write notes on various factors affecting solubility.

3. a) What happens when  $\text{MgSO}_4 \cdot 7\text{H}_2\text{O}$  is heated? Write the appropriate equation  
b) Define solubility
4. In what way hygroscopic substances differ from deliquescent substances.
5. A solution is prepared by dissolving 45 g of sugar in 180 g of water. Calculate the mass percentage of solute.
6. 3.5 litres of ethanol is present in 15 litres of aqueous solution of ethanol. Calculate volume percent of ethanol solution.

**VII. HOTS**

1. Vinu dissolves 50 g of sugar in 250 ml of hot water, Sarath dissolves 50 g of same sugar in 250 ml of cold water. Who will get faster dissolution of sugar? and Why?
2. 'A' is a blue coloured crystalline salt. On heating it loses blue colour and to give 'B'. When water is added, 'B' gives back to 'A'. Identify A and B, write the equation.
3. Will the cool drinks give more fizz at top of the hills or at the foot? Explain

**REFERENCE BOOKS**

1. Properties Liquids Solutions John Murrell 2<sup>nd</sup> Edition.
2. Fundamental Interrelationships Between Certain Soluble Salts and Soil Colloids (Classic Reprint) Hardcover, by Leslie Theodore Sharp

**INTERNET RESOURCES**

1. <https://www.cwcboe.org/cms/lib/NJ01001185/Centricity/Domain/203/Solutions%20Suspensions%20and%20Colloids.pdf>

## Concept Map

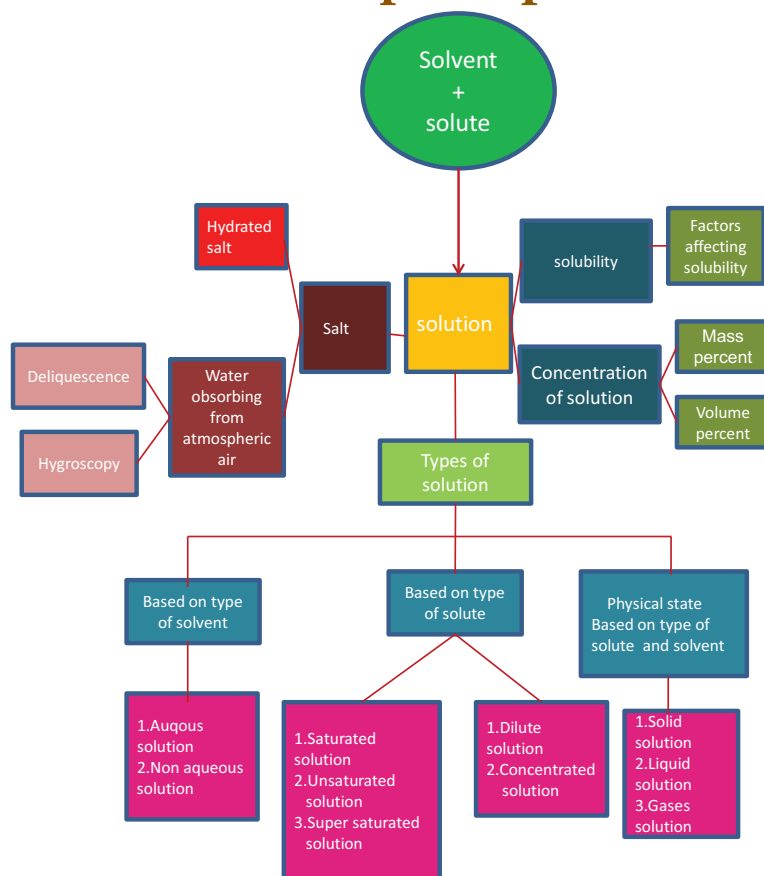

### ICT CORNER

### Solutions

**BEAKER application enable the students to use their mobile as virtual chemistry laboratory and also to do various experiments on their own.**

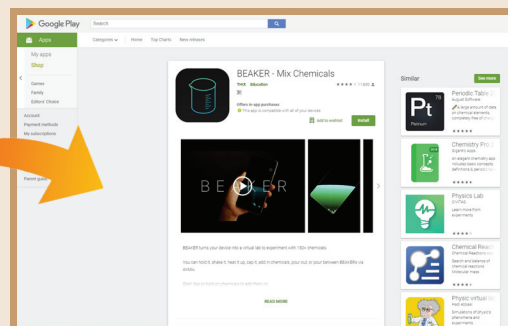

#### Steps

- Access the application “BEAKER – Mix Chemicals” with help of the URL or QR code, Install it in the mobile. You can see that the screen will act like a beaker after opening the application.
- If you click the round button, you can see many elements and compounds.
- If you click any elements and compounds, it will be added to the beaker in the home screen.
- By clicking Menu at the left side, You can see lid, match stick, burner and chemist. Use those whenever necessary.

URL: <https://play.google.com/store/apps/details?id=air.thix.sciencesense.beaker>  
or Scan the QR Code.



B375\_10\_SCIENCE\_EM





# UNIT 10



# TYPES OF CHEMICAL REACTIONS



## Learning Objectives



GKWN5A

After completing this lesson learners will be able to

- ◆ infer different types of chemical reaction.
- ◆ acquire knowledge about combination reaction and skill to perform a combination reaction using quick lime and water.
- ◆ identify and differentiate between reversible and irreversible reactions.
- ◆ explain the reversible reaction occurring at the equilibrium state.
- ◆ list and explain characteristics of equilibrium state.
- ◆ define rate of reaction.
- ◆ discuss the dependence of rate of reactions on concentration, temperature and catalyst.
- ◆ define pH.
- ◆ correlate the concentration of hydrogen ions and pH with neutral, acidic and basic nature of aqueous solutions.
- ◆ recognize the importance of pH in everyday life.
- ◆ explain the term ionic product of water.

## INTRODUCTION

As you know from your earlier studies, a chemical reaction involves breaking of old chemical bonds and formation of new chemical bonds. This change may happen spontaneously or it may be facilitated by external forces or energy. Chemistry is all about chemical reactions. In your day to day life, you could observe many chemical reactions. A clear understanding of these reactions is essential in order to manipulate them for the sake of human life and environment. So, chemistry mainly focuses on chemical reactions. Let us try to find the answer for the following questions:

- ◆ You need energy to play, walk, run or to perform various physical activities. Where do you get the energy from?

- ◆ How do plants grow and get their food?
- ◆ How does a car move using fuel?
- ◆ Why does iron rust on its exposure to water or air?

You get energy from the digestion of the food you eat. Plants grow by absorbing nutrients from the Earth and get their food by photosynthesis. The combustion of a fuel makes the car to move. Oxidation of iron causes rusting. So, all these processes are chemical changes i.e. the materials, which undergo changes are converted into some other new materials. For example, by burning petrol, the hydrocarbons present in it are converted into carbon dioxide and water. In this chapter, let us discuss the nature and types of chemical reactions.

### What happens during a chemical reaction?

- ◆ In a chemical reaction, the atoms of the reacting molecules or elements are rearranged to form new molecules.
- ◆ Old chemical bonds between atoms are broken and new chemical bonds are formed.
- ◆ Bond breaking absorbs energy whereas bond formation releases energy

### How are chemical reactions represented?

When methane reacts with oxygen, it forms carbon dioxide and water. How can you represent this reaction? It can be written as a word equation as shown below:

**Methane + Oxygen → Carbon dioxide + Water**

But, this equation does not give the chemical composition of the reactants and products. So, to learn the characteristics of a chemical reaction, it is represented by a chemical equation. In the chemical equation, the chemicals of the reaction are represented by their chemical formulas. The compounds or elements, which undergo reactions (reactants) are shown to the left of an arrow and the compounds formed (products) are shown to the right of the arrow. The arrow indicates the direction of the reaction. Thus, the aforesaid reaction can be written as follows:

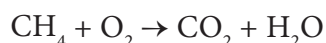

But, this is also an incomplete chemical equation. Because, the law of conservation of matter states that matter cannot be created or destroyed. You cannot create new atoms by a chemical reaction. In contrast, they are rearranged in different ways by a chemical reaction to form a new compound. So, in a chemical equation, the number of atoms of the reactants and that of the products must be equal. The number of hydrogen and oxygen atoms in the reactants and the products are not

equal in the given equation. On balancing the number of atoms, the following equation can be obtained:

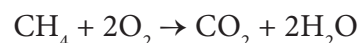

Further, the chemical equation provides information on the physical state of the substances and the conditions under which the reaction takes place.

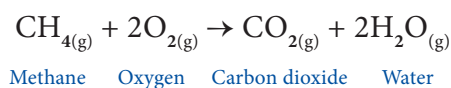

**A balanced chemical equation is the simplified representation of a chemical reaction which describes the chemical composition, physical state of the reactants and the products, and the reaction conditions.**

### MORE TO KNOW

The phases or the physical state of the substances in a chemical reaction are denoted in short form within a bracket, as the subscript of the formula, of the respective substances. For example, when solid potassium reacts with liquid water, it produces hydrogen gas and potassium hydroxide solution. All these information of the reaction is given in the chemical equation as shown below:

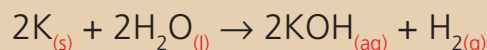

Symbol	Phase or physical state
s	Solid
l	Liquid
g	Gas
aq	Aqueous Solution

## 10.1 TYPES OF CHEMICAL REACTIONS

### Classification based on the nature of rearrangements of atoms

So far you studied about a chemical reaction and how it can be described as a chemical equation. A large number of chemical reactions are taking place around us every day. Are they taking place in a similar way? No. Each reaction involves different kinds of atoms and hence the way they react also differs. Thus, based on the manner by which the atoms of the reactants are rearranged, chemical reactions are classified as follows.



#### (a) Combination reactions

A combination reaction is a reaction in which two or more reactants combine to form a compound. It is otherwise called 'synthesis reaction' or 'composition reaction'. When a reactant 'A' combines with 'B', it forms the product 'AB'. The generalised scheme of a combination reaction is given below:



**Example:** Hydrogen gas combines with chlorine gas to form hydrogen chloride gas.

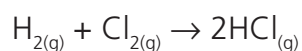

Depending on the chemical nature of the reactants, there are **three classes** of combination reactions:

#### ❖ Element + Element → Compound

In this type of combination reaction, two elements react with one other to form a compound. The reaction may take place between a metal and a non-metal or two non-metals.

**Example 1:** When solid sulphur reacts with oxygen, it produces sulphur dioxide. Here both the reactants are non-metals.

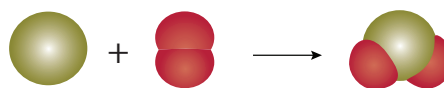

**Example 2:** Sodium, a silvery-white metal, combines with chlorine, a pale yellow green gas, to form sodium chloride, an edible compound. Here one of the reactants is a metal (sodium) and the other (chlorine) is a non-metal.

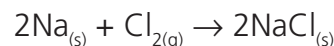

#### Test Yourself:

Identify the possible combination reactions between the metals and non-metals given in the following table and write their balanced chemical equations:

Metals	Non-metals
Na, K, Cs, Ca, Mg	F, Cl, Br, I

#### ❖ Compound + Element → Compound

In this case, a compound reacts with an element to form a new compound. For instance, phosphorous trichloride reacts with chlorine gas and forms phosphorous pentachloride.



#### ❖ Compound + Compound → Compound

It is a reaction between two compounds to form a new compound. In the following reaction, silicon dioxide reacts with calcium oxide to form calcium silicate.

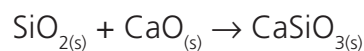

Most of the combination reactions are exothermic in nature. Because, they involve the formation of new bonds, which releases a huge amount of energy in the form of heat.

**(b) Decomposition reactions**

In a decomposition reaction, a single compound splits into two or more simpler substances under suitable conditions. It is the opposite of the combination reaction. The **generalised scheme** of a decomposition reaction is given below:

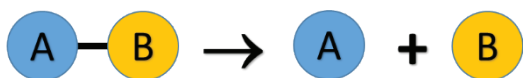

Breaking of bonds is the major phenomenon in a decomposition reaction and hence it requires energy to break the bonds, depending on the nature of the energy used in the decomposition reaction.

There are three main classes of decomposition reactions. They are

- (i) Thermal Decomposition Reactions
- (ii) Electrolytic Decomposition Reactions
- (iii) Photo Decomposition Reactions

**DO YOU KNOW?**

A solution of slaked lime is used for white washing walls. Calcium hydroxide reacts slowly with the carbon dioxide in air to form a thin layer of calcium carbonate on the walls. Calcium carbonate is formed after two to three days of white washing and gives a shiny finish to the walls. It is interesting to note that the **chemical formula for marble is also**  $\text{CaCO}_3$

$$\text{Ca(OH)}_{2(aq)} + \text{CO}_{2(g)} \rightarrow \text{CaCO}_{3(s)} + \text{H}_2\text{O}_{(l)}$$

Slaked Lime	Carbon dioxide	Calcium Carbonate	Water
-------------	----------------	-------------------	-------

**(i) Thermal Decomposition Reactions**

In this type of reaction, the reactant is decomposed by applying heat. For example, on heating mercury (II) oxide is decomposed into mercury metal and oxygen gas. As the molecule is dissociated by the absorption of heat, it is otherwise called '**Thermolysis**'. It is a class of compound to element/element decomposition. i.e. a compound ( $\text{HgO}$ ) is decomposed into two elements ( $\text{Hg}$  and  $\text{Oxygen}$ ).

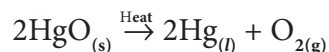

Similarly, when calcium carbonate is heated, it breaks down into calcium oxide and carbon dioxide. It is a type of compound to compound/compound decomposition.



In thermal decomposition reaction, heat is supplied to break the bonds. Such reactions, in which heat is absorbed, are called '**Endothermic reactions**'.

**(ii) Electrolytic Decomposition Reactions**

In some of the decomposition reactions, electrical energy is used to bring about the reaction. For example, decomposition of sodium chloride occurs on passing electric current through its aqueous solution. Sodium chloride decomposes into metallic sodium and chlorine gas. This process is termed as 'Electrolysis'.

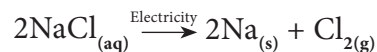

Here, a compound ( $\text{NaCl}$ ) is converted into elements ( $\text{Na}$  and  $\text{chlorine}$ ). So it is a type of compound to element/element decomposition.

**(iii) Photo Decomposition Reactions**

Light is another form of energy, which facilitates some of the decomposition reactions. For example, when silver bromide is exposed to light, it breaks down into silver metal and bromine gas. As the decomposition is caused by light, this kind of reaction is also called '**Photolysis**'.

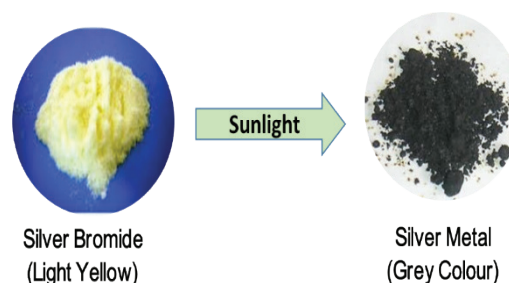
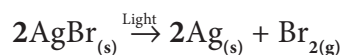

**Figure 10.1** Photo decomposition of silver bromide

The yellow coloured silver bromide turns into grey coloured silver metal. It is also a compound to element/element decomposition.

### (c) Single Displacement Reactions

It is a reaction between an element and a compound. When they react, one of the elements of the compound-reactant is replaced by the element-reactant to form a new compound and an element. The general schematic representation of a single displacement reaction is given as:



'A' displaces element 'B' from the compound 'BC' and hence a single displacement reaction occurs. If zinc metal is placed in hydrochloric acid, hydrogen gas is evolved. Here, hydrogen is displaced by zinc metal and zinc chloride is formed.

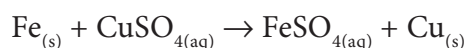
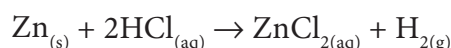

If an iron nail is placed in an aqueous solution of copper (II) sulphate as shown in Fig. 10.2, the iron displaces copper from its aqueous solution and the so formed copper deposits over the iron nail.

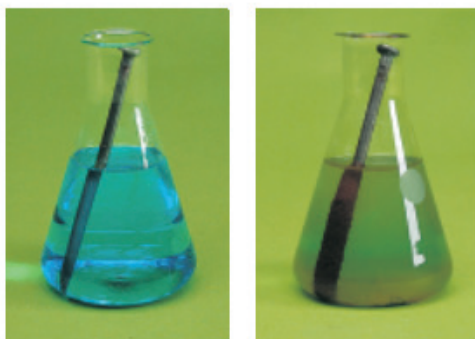
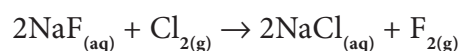
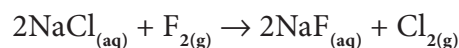

Figure 10.2 Displacement of copper

It is easy to propose so many reactions of this kind with different combinations of

reactants. Will they all occur in practice? No. This is most easily demonstrated with halogens. Let us consider the following two reactions:



The first reaction involves the displacement of chlorine from NaCl, by fluorine. In the second reaction, chlorine displaces fluorine from NaF. Out of these two, the second reaction will not occur. Because, fluorine is more active than chlorine and occupies the upper position in the periodic table. So, in displacement reactions, the activity of the elements and their relative position in the periodic table are the key factors to determine the feasibility of the reactions. More active elements readily displace less active elements from their aqueous solution.

The activity series of some elements is given below:

To remember	Activity Series
↓	↓
• Please	Potassium (K)
• Send	Sodium (Na)
• Lions	Lithium (Li)
• Cats	Calcium (Ca)
• Monkeys	Magnesium (Mg)
• And	Aluminium (Al)
• Zebras	Zinc (Zn)
• Into	Iron (Fe)
• Lovely	Lead (Pb)
• Hot	Hydrogen (H) non-metal
• Countries	Copper (Cu)
• Signed	Silver (Ag)
• General	Gold (Au)
• Penguin	Platinum (Pt)
	↑ Most reactive
	Least reactive

By referring the activity series, try to answer the following questions:

Which of the metals displaces hydrogen gas from hydrochloric acid? Silver or Zinc. Give the chemical equation of the reaction and Justify your answer.

**Activity 10.1**

- ❖ Take about 50 ml of toilet cleaning acid in a beaker
- ❖ Place a small iron nail in it
- ❖ Wait for about 10 minutes
- ❖ Observe what happen in the beaker
- ❖ Do you recognize any change?
- ❖ Report your observations with the chemical equation.

**(d) Double Displacement Reactions**

When two compounds react, if their ions are interchanged, then the reaction is called double displacement reaction. The ion of one compound is replaced by the ion of the another compound. Ions of identical charges are only interchanged, i.e., a cation can be replaced by other cations. This reaction is also called 'Metathesis Reaction'. The schematic representation of a double displacement reaction is given below:

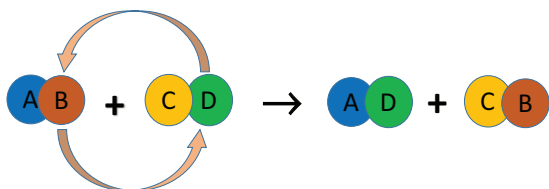

In a double displacement reaction either one of the products must be either a precipitate or water. By this way, there are major classes of double displacement reactions. They are:

- (i) Precipitation Reactions
- (ii) Neutralization Reactions

**(i) Precipitation Reactions**

When aqueous solutions of two compounds are mixed, if they react to form an insoluble compound and a soluble compound, then it is called precipitation reaction. Because the insoluble compound, formed as one of the products, is a precipitate and hence the reaction is so called.

**Table 10.1** Differences between combination and decomposition reactions

COMBINATION REACTIONS	DECOMPOSITION REACTIONS
One or more reactants combine to form a single product	A single reactant is decomposed to form one or more products
Energy is released	Energy is absorbed
Elements or compounds may be the reactants	Single compound is the reactant

When the clear aqueous solutions of potassium iodide and lead (II) nitrate are mixed, a double displacement reaction takes place between them.

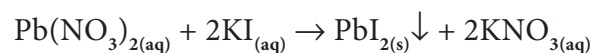

Potassium and lead displace or replace one other and form a yellow precipitate of lead (II) iodide as shown in Fig. 10.3.



**Figure 10.3** Precipitation of  $\text{PbI}_2$

**Activity 10.2**

- ❖ Take a pinch of silver nitrate crystals.
- ❖ Collect about 5 ml of tap water in a test tube.
- ❖ Add the silver nitrate crystals to water and shake well.
- ❖ Observe what happen in the test tube.
- ❖ Report your observations and what you infer from that?

**(ii) Neutralization Reactions**

In your lower classes, you have learned the reaction between an acid and a base. It is

another type of displacement reaction in which the acid reacts with the base to form a salt and water. It is called 'neutralization reaction' as both acid and base neutralize each other.

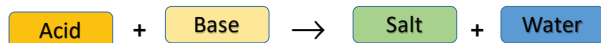

Reaction of sodium hydroxide with hydrochloric acid is a typical neutralization reaction. Here, sodium replaces hydrogen from hydrochloric acid forming sodium chloride, a neutral soluble salt.

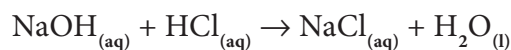

Similarly, when ammonium hydroxide reacts with nitric acid, it forms ammonium nitrate and water.

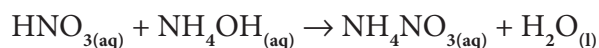

### (e) Combustion Reactions

A combustion reaction is one in which the reactant rapidly combines with oxygen to form one or more oxides and energy (heat). So in combustion reactions, one of the reactants must be oxygen. Combustion reactions are majorly used as heat energy sources in many of our day to day activities. For instance, we use LPG gas for domestic cooking purposes. We get heat and flame from LPG gas by its combustion reaction of its constituent gases. LPG is a mixture of hydrocarbon gases like propane, butane, propylene, etc. All these hydrocarbons burn with oxygen to form carbon dioxide and water.

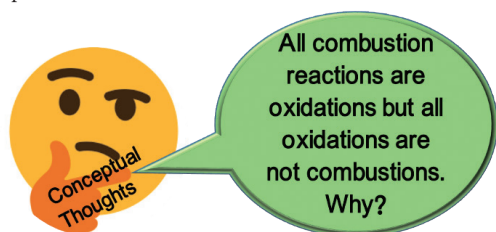
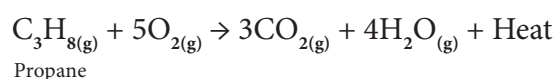

Since heat is evolved, it is an exothermic reaction. As oxygen is added, it is also an oxidation. So, combustion may be called as an

exothermic oxidation. If a flame is formed (as shown in Fig. 10.4), then it is called **burning**.



Figure 10.4 Combustion of LPG gas

Which of the following is a combustion?

- (i) Digestion of Food
- (ii) Rusting of iron

Many thousands of reactions fall under these five categories and further you will learn in detail about these reactions in your higher classes.

### 10.1.2 Classification based on the direction of the reaction

You know that innumerable changes occur every day around us. Are all they permanent? For example, liquid water freezes into ice, but then ice melts into liquid water. In other words, freezing is reversed. So, it is not a permanent change. Moreover, it is a physical change. Physical changes can be reversed easily. Can chemical changes be reversed? Can the products be converted into reactants? Let us consider the burning of a wood. The carbon compounds present in the wood are burnt into carbon dioxide gas and water. Can we get back the wood immediately from carbon dioxide and water? We cannot. So, it is a permanent change. In most of the cases, we cannot. But, some chemical reactions can be reversed. Our mobile phone gets energy from its lithium ion battery by chemical reactions. It is called discharging. On recharging the mobile, these chemical reactions are reversed. Thus, chemical reactions may be reversed under suitable conditions. Hence, they are

grouped into two categories such as reversible and irreversible reactions.



**Figure 10.5** Burning of wood and recharging of mobile battery

### Reversible Reactions

A reversible reaction is a reaction in which the products can be converted back to the reactants. A reversible reaction is represented by a double arrow with their heads in the direction opposite to each other. Thus, a reversible reaction can be represented by the following equation:

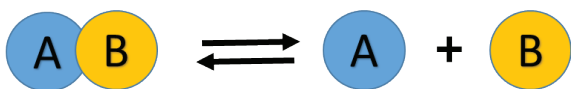

**Explanation:** Here, the compound 'AB' undergoes decomposition to form the products 'A' and 'B'. It is the **forward reaction**. As soon as the products are formed, they combine together to form 'AB'. It is the **backward reaction**. So, the reaction takes place in both the directions. Do you think then that no products are formed in the aforesaid reaction? If you think so, you are wrong. Because, even though the reaction takes place in both the directions, at the initial stage the rates (speed) of these reactions are not equal. Consider the following decomposition reaction of phosphorous pentachloride into phosphorous trichloride and chlorine.



The forward reaction is the decomposition of  $\text{PCl}_5$  and the backward reaction is the combination of  $\text{PCl}_3$  and  $\text{Cl}_2$ . Initially, the forward reaction proceeds faster than the

backward reaction. After sometimes, the speed of both the reactions become equal. So,  $\text{PCl}_5$  cannot be completely converted into the products as the reaction is reversed. It is a reversible reaction. The actual measurements of the given reaction show that the reaction is at equilibrium, but the amount of  $\text{PCl}_5$  is more than that of  $\text{PCl}_3$  and  $\text{Cl}_2$ .

### MORE TO KNOW

If hydrogen peroxide is poured on a wound, it decomposes into water and oxygen. The gaseous oxygen bubbles away as it is formed and thus prevent the formation of  $\text{H}_2\text{O}_2$ .



**Hydrogen peroxide on a wound**

Thus, more amount of products can be obtained in a reversible reaction by the periodical removal of one of the products or the periodical addition of the reactants.

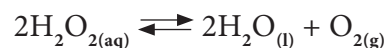

### Irreversible Reactions

The reaction that cannot be reversed is called **irreversible reaction**. The irreversible reactions are unidirectional, i.e., they take place only in the forward direction. Consider the combustion of coal into carbon dioxide and water.

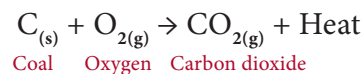

In this reaction, solid coal burns with oxygen and gets converted into carbon dioxide gas and water. As the product is a gas, as soon as it is formed it escapes out of the reaction container. It is extremely hard to decompose a gas into a solid. Thus, the backward reaction is not possible in this case. So, it is an irreversible reaction. Table 10.2 provides the



main differences between a reversible and an irreversible reaction:

**Table 10.2** Differences between reversible and irreversible reactions

REVERSIBLE REACTION	IRREVERSIBLE REACTION
It can be reversed under suitable conditions.	It cannot be reversed.
Both forward and backward reactions take place simultaneously.	It is unidirectional. It proceeds only in forward direction.
It attains equilibrium.	Equilibrium is not attained.
The reactants cannot be converted completely into products.	The reactants can be completely converted into products.
It is relatively slow.	It is fast.

You will learn more about these reactions in your higher classes.

## 10.2 RATE OF A CHEMICAL REACTION

So far we discussed various types of chemical reactions and the nature of the reactants and products. Let us consider the following reactions:

- ◆ Rusting of iron
- ◆ Digestion of food
- ◆ Burning of petrol
- ◆ Weathering of rock

How fast is each reaction? Rank them from the slowest to fastest. How will you determine, which is the fastest and which is the slowest? One of the ways to find out how fast a reaction is as follows: Measure the amount of reactants or products before and after a specific period of time. For example, let us assume that 100 g

of a substance 'A' undergoes a reaction and after an hour 50 g of 'A' is left.



In another instance, 100 g of substance 'C' undergoes a reaction and after an hour, 20 g of 'C' is left.



Can you say which is the faster reaction? In the first reaction, 50 g of the reactant (A) is converted into products whereas in the second reaction 80 g of the reactant is converted into products in one hour. So, the second reaction is faster. This measurement is called 'the reaction rate'.

"Rate of a reaction is the change in the amount or concentration of any one of the reactants or products per unit time".

Consider the following reaction

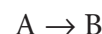

The rate of this reaction is given by

$$\text{Rate} = -\frac{d[A]}{dt} = +\frac{d[B]}{dt}$$

Where,

[A] – Concentration of A

[B] – Concentration of B

The negative sign indicates the decrease in the concentration of A with time.

The positive sign indicates the increase in the concentration of B with time.

**Note:** '[ ]' represents the concentration, 'd' represents the infinitesimal change in the concentration.

### Why is reaction rate important?

Faster the reaction, more will be the amount of the product in a specified time. So, the rate of a reaction is important for a chemist for designing a process to get a good yield of a product. Rate of reaction is also important for a food processor who hopes to slow down the reactions that cause food to spoil.

### 10.2.1 Factors influencing the rate of a reaction

Can the rate of a reaction be changed? The rate of a reaction can be changed. For

example, iron gets rusted faster in an acid than in water. Important factors that affect rate of a reaction are

- (i) Nature of the reactants
- (ii) Concentration of the reactants
- (iii) Temperature
- (iv) Catalyst
- (v) Pressure
- (vi) Surface area of the reactants

#### (i) Nature of the reactants

The reaction of sodium with hydrochloric acid is faster than that with acetic acid. Do you know why? Hydrochloric acid is a stronger acid than acetic acid and thus more reactive. So, the nature of the reactants influence the reaction rate.

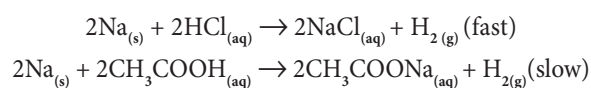

#### (ii) Concentration of the reactants

Changing the amount of the reactants also increases the reaction rate. The amount of the substance present in a certain volume of the solution is called '**concentration**'. More the concentration, more particles per volume exist in it and hence faster the reaction. Granulated zinc reacts faster with 2M hydrochloric acid than 1M hydrochloric acid.

#### (iii) Temperature

Most of the reactions go faster at higher temperature. Because adding heat to the reactants provides energy to break more bonds and thus speed up the reaction. Calcium carbonate reacts slowly with hydrochloric acid at room temperature. When the reaction mixture is heated the reaction rate increases.



Food kept at room temperature spoils faster than that kept in the refrigerator. In the refrigerator, the temperature is lower than the room temperature and hence the reaction rate is less.

#### (iv) Pressure

If the reactants are gases, increasing their pressure increases the reaction rate. This is because, on increasing the pressure the reacting particles come closer and collide frequently.

#### (v) Catalyst

A catalyst is a substance which increases the reaction rate without being consumed in the reaction. In certain reactions, adding a substance as catalyst speeds up the reaction. For example, on heating potassium chlorate, it decomposes into potassium chloride and oxygen gas, but at a slower rate. If manganese dioxide is added, it increases the reaction rate.

#### (vi) Surface area of the reactants

When solid reactants are involved in a reaction, their powdered form reacts more readily. For example, powdered calcium carbonate reacts more readily with hydrochloric acid than marble chips. Because, powdering of the reactants increases the surface area and more energy is available on collision of the reactant particles. Thus, the reaction rate is increased.

You will study more about reaction rate in your higher classes.

## 10.3 STATE OF EQUILIBRIUM

In a reversible reaction, both forward and backward reactions take place simultaneously. When the rate of the forward reaction becomes equal to the rate of backward reaction, then no more product is formed. This stage of the reaction is called '**equilibrium state**'. After this stage, no net change in the reaction can occur and hence in the amount of the reactants and products. Since this equilibrium is attained in a chemical reaction, it is called 'Chemical Equilibrium'. **Chemical Equilibrium: It is state of a reversible chemical reaction in which no change in the amount of the reactants and products takes place. At equilibrium,**

**Rate of forward reaction = Rate of backward reaction**

**Explanation:** Initially the rate of the forward reaction is greater than the rate of the backward reaction. However, during the course of reaction, the concentration of the reactants decreases and the concentration of the products increases. Since the rate of a reaction is directly proportional to the concentration, the rate of the forward reaction decreases with time, whereas the rate of the backward reaction increases.

At a certain stage, both the rates become equal. From this point onwards, there will be no change in the concentrations of both the reactants and the products with time. This state is called as equilibrium state.

Let us consider the decomposition of calcium carbonate into lime and carbon dioxide. It is a reversible reaction. The speed of each reaction can be determined by how quickly the reactant disappears. If the reaction is carried out in a closed vessel, it reaches a chemical equilibrium. At this stage,



The rate of decomposition of  $\text{CaCO}_3$  = The rate of combination of  $\text{CaO}$  and  $\text{CO}_2$

Not only chemical changes, physical changes also may attain equilibrium. When water kept in a closed vessel evaporates, it forms water vapour. No water vapour escapes out of the container as the process takes place in a closed vessel. So, it builds up the vapour pressure in the container. At one time, the water vapour condenses back into liquid water and when the rate of this condensation becomes equal to that of vapourisation, the process attains equilibrium.

At this stage, the volume of the liquid and gaseous phases remain constant. Since it is a physical change, the equilibrium attained is called '**Physical Equilibrium**'. Physical equilibrium is a state of a physical change at which the volume of all the phases remain unchanged.

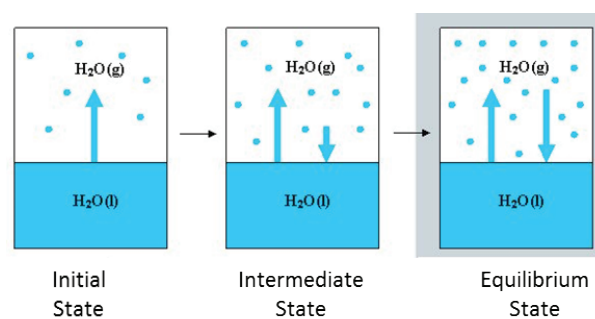

Figure 10.6 State of physical equilibrium

### Characteristics of equilibrium

- ◆ In a chemical equilibrium, the rates of the forward and backward reactions are equal.
- ◆ The observable properties such as pressure, concentration, colour, density, viscosity etc., of the system remain unchanged with time.
- ◆ The chemical equilibrium is a dynamic equilibrium, because both the forward and backward reactions continue to occur even though it appears static externally.
- ◆ In physical equilibrium, the volume of all the phases remain constant.

Aerated soft drinks contain dissolved carbon dioxide in a pop bottle (Soda).



When the bottle is sealed, the dissolved carbon dioxide (in the form of carbonic acid) and gaseous  $\text{CO}_2$  are in equilibrium with each other. When you open the bottle, the gaseous  $\text{CO}_2$  can escape. So, the dissolved  $\text{CO}_2$  begins to undissolve back to the gas phase trying to replace the gas that was lost, when you opened the bottle. That's why if you leave it open long enough, it will go 'flat'. All the  $\text{CO}_2$  will be gone, blown away in the air.

### 10.4 IONIC PRODUCT OF WATER

Although pure water is often considered as a non-conductor of electricity, precise measurements show that it conducts electricity to a little extent. This conductivity of water has resulted from the self-ionisation of water. Self-ionisation or auto ionisation is a reaction in which two like molecules react to give ions. In the process of ionisation of water, a proton from one water molecule is transferred to another water molecule leaving behind an  $\text{OH}^-$  ion. The proton gets dissolved in water forming the hydronium ion as shown in the following equation:

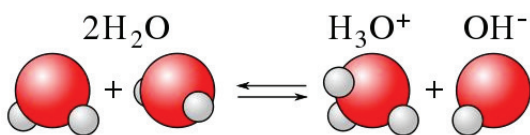
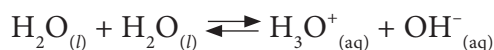

The hydronium ion formed is a strong acid and the hydroxyl ion is a strong base. So as fast as they are formed, they react again to produce water. Thus, it is a reversible reaction and attains equilibrium very quickly. So, the extent of ionisation is very little and the concentration of the ions produced is also very less. The product of the concentration of the hydronium ion and the hydroxyl ion is called 'ionic product of water'. It is denoted as ' $K_w$ '. It is mathematically expressed as follows:

$$K_w = [\text{H}_3\text{O}^+] [\text{OH}^-]$$

$[\text{H}_3\text{O}^+]$  may be simply written as  $[\text{H}^+]$ . Thus the ionic product of water may also be expressed as

$$K_w = [\text{H}^+] [\text{OH}^-]$$

Its unit is  $\text{mol}^2 \text{dm}^{-6}$ . At  $25^\circ \text{C}$ , its value is  $1.00 \times 10^{-14}$ .

### 10.5 pH SCALE

All the aqueous solutions may contain hydrogen and hydroxyl ions due to self-ionisation of water. In addition to this ionisation, substances dissolved in water also may produce hydrogen ions or hydroxyl ions. The concentration of these ions decides whether the solution is acidic or basic. pH scale is a scale for measuring the hydrogen ion concentration in a solution. The 'p' in pH stands for 'Potenz' in German meaning 'power'. pH notation was devised by the Danish biochemist Sorensen in 1909. pH scale is a set of numbers from 0 to 14 which is used to indicate whether a solution is acidic, basic or neutral.

- ✓ Acids have pH less than 7
- ✓ Bases have pH greater than 7
- ✓ A neutral solution has pH equal to 7

**The pH is the negative logarithm of the hydrogen ion concentration**

$$\text{i.e } \text{pH} = -\log_{10}[\text{H}^+]$$

COMMON ACIDS	pH	COMMON BASES	pH
HCl (4%)	0	Blood plasma	7.4
Stomach acid	1	Egg white	8
Lemon juice	2	Sea water	8
Vinegar	3	Baking soda	9
Oranges	3.5	Antacids	10
Soda, grapes	4	Ammonia water	11
Sour milk	4.5	Lime water	12
Fresh milk	5	Drain cleaner	13
Human saliva	6-8	Caustic soda 4% (NaOH)	14
Pure water	7	Milk of magnesia	10
Tomato juice	4.2	Coffee	5.6

**How can we measure the pH of a given solution using pH Paper**

The pH of a solution can be determined by using a universal indicator. It contains a mixture of dyes. It comes in the form of a solution or a pH paper.

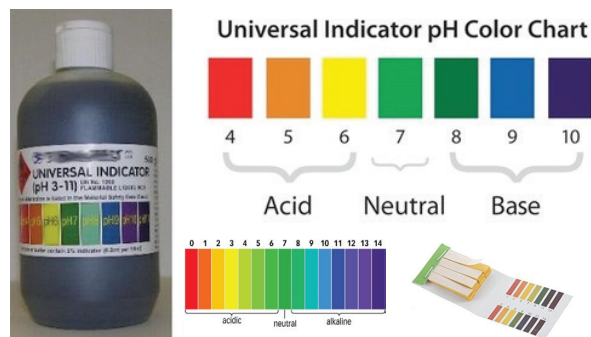

Figure 10.7 pH Indicator

A more common method of measuring pH in a school laboratory is by using the pH paper. A pH paper contains a mixture of indicators. It shows a specific colour at a given pH. A colour guide is provided with the bottle of the indicator or the strips of paper impregnated with it, which are called pH paper strips. The test solution is tested with a drop of the universal indicator, or a drop of the test solution is put on the pH paper. The colour of the solution on the pH paper is compared with the colour chart and the pH value is read from it. The pH values thus obtained are only approximate values.

## 10.6 ROLE OF pH IN EVERYDAY LIFE

### Are plants and animals pH sensitive?

Our body works within the pH range of 7.0 to 7.8. Living organisms can survive only in a narrow range of pH change. Different body fluids have different pH values. For example, pH of blood is ranging from 7.35 to 7.45. Any increase or decrease in this value leads to diseases. The ideal pH for blood is 7.4.

### pH in our digestive system

It is very interesting to note that our stomach produces hydrochloric acid. It helps in the digestion of food without harming the stomach. During indigestion the stomach produces too much acid and this causes pain and irritation. pH of the stomach fluid is approximately 2.0.

### pH changes as the cause of tooth decay

pH of the saliva normally ranges between 6.5 to 7.5. White enamel coating of our teeth is calcium phosphate, the hardest substance in our body. When the pH of the mouth saliva falls below 5.5, the enamel gets weathered. Toothpastes, which are generally basic are used for cleaning the teeth that can neutralise the excess acid and prevent tooth decay.

### pH of soil

In agriculture, the pH of the soil is very important. Citrus fruits require slightly alkaline soil, while rice requires acidic soil and sugarcane requires neutral soil.

### pH of rain water

The pH of rain water is approximately 7, which means that it is neutral and also represents its high purity. If the atmospheric air is polluted with oxide gases of sulphur and nitrogen, they get dissolved in the rain water and make its pH less than 7. Thus, if the pH of rain water is less than 7, then it is called acid rain. When acid rain flows into the rivers it lowers the pH of the river water also.

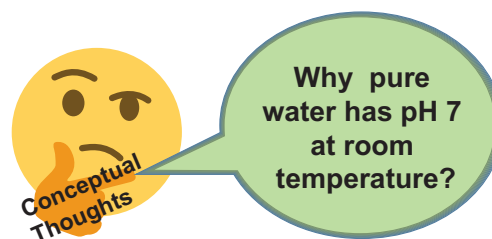

The survival of aquatic life in such rivers becomes difficult.

### 10.7 pH CALCULATION

The pH is the negative logarithm of the hydrogen ion concentration

$$\text{pH} = -\log_{10} [\text{H}^+]$$

**Example:** Calculate the pH of 0.01 M HNO<sub>3</sub>?

**Solution:**

$$[\text{H}^+] = 0.01$$

$$\text{pH} = -\log_{10} [\text{H}^+]$$

$$\text{pH} = -\log_{10} [0.01]$$

$$\text{pH} = -\log_{10} [1 \times 10^{-2}]$$

$$\text{pH} = -(\log_{10} 1 - 2 \log_{10} 10)$$

$$\text{pH} = 0 + 2 \times \log_{10} 10$$

$$\text{pH} = 0 + 2 \times 1 = 2$$

$$\text{pH} = 2$$

**pOH:** The pOH of an aqueous solution is related to the pH.

The pOH is the negative logarithm of the hydroxyl ion concentration

$$\text{pOH} = -\log_{10} [\text{OH}^-]$$

**Example:** The hydroxyl ion concentration of a solution is  $1 \times 10^{-9}$  M. What is the pOH of the solution?

**Solution**

$$\text{pOH} = -\log_{10} [\text{OH}^-]$$

$$\text{pOH} = -\log_{10} [1 \times 10^{-9}]$$

$$\text{pOH} = -(\log_{10} 1.0 + \log_{10} 10^{-9})$$

$$\text{pOH} = -(0 - 9 \log_{10} 10)$$

$$\text{pOH} = -(0 - 9)$$

$$\text{pOH} = 9$$

#### Relationship between pH and pOH

The pH and pOH of a water solution at 25°C are related by the following equation.

$$\text{pH} + \text{pOH} = 14$$

If either the pH or the pOH of a solution is known, the other value can be calculated.

**Example:** A solution has a pOH of 11.76. What is the pH of this solution?

$$\text{pH} = 14 - \text{pOH}$$

$$\text{pH} = 14 - 11.76 = 2.24$$

### 10.8 PROBLEMS

**Example 1:** Calculate the pH of 0.001 molar solution of HCl.

**Solution:** HCl is a strong acid and is completely dissociated in its solutions according to the process:



From this process it is clear that one mole of HCl would give one mole of H<sup>+</sup> ions. Therefore, the concentration of H<sup>+</sup> ions would be equal to that of HCl, i.e., 0.001 molar or  $1.0 \times 10^{-3}$  mol litre<sup>-1</sup>.

Thus,  $[\text{H}^+] = 1 \times 10^{-3}$  mol litre<sup>-1</sup>

$$\text{pH} = -\log_{10} [\text{H}^+] = -\log_{10} 10^{-3}$$

$$= -(-3 \times \log_{10}) = -(3 \times 1) = 3$$

Thus, pH = 3

**Example 2:** What would be the pH of an aqueous solution of sulphuric acid which is  $5 \times 10^{-5}$  mol litre<sup>-1</sup> in concentration.

**Solution:** Sulphuric acid dissociates in water as:



Each mole of sulphuric acid gives two mole of H<sup>+</sup> ions in the solution. One litre of H<sub>2</sub>SO<sub>4</sub> solution contains  $5 \times 10^{-5}$  moles of H<sub>2</sub>SO<sub>4</sub> which would give  $2 \times 5 \times 10^{-5} = 10 \times 10^{-5}$  or  $1.0 \times 10^{-4}$  moles of H<sup>+</sup> ion in one litre of the solution.

Therefore,

$$[\text{H}^+] = 1.0 \times 10^{-4} \text{ mol litre}^{-1}$$

$$\text{pH} = -\log_{10} [\text{H}^+] = -\log_{10} 10^{-4} = -(-4 \times \log_{10} 10)$$

$$= -(-4 \times 1) = 4$$

**Example 3:** Calculate the pH of  $1 \times 10^{-4}$  molar solution of NaOH.

**Solution:** NaOH is a strong base and dissociates in its solution as:



One mole of NaOH would give one mole of OH<sup>-</sup> ions. Therefore,

$$[\text{OH}^-] = 1 \times 10^{-4} \text{ mol litre}^{-1}$$

$$\text{pOH} = -\log_{10}[\text{OH}^-] = -\log_{10} \times [10^{-4}]$$

$$= -(-4 \times \log_{10} 10) = -(-4) = 4$$

Since,  $\text{pH} + \text{pOH} = 14$   
 $\text{pH} = 14 - \text{pOH} = 14 - 4$   
 $= 10$

**Example 4:** Calculate the pH of a solution in which the concentration of the hydrogen ions is  $1.0 \times 10^{-8} \text{ mol litre}^{-1}$ .

**Solution:** Here, although the solution is extremely dilute, the concentration given is not of an acid or a base but that of  $\text{H}^+$  ions. Hence, the pH can be calculated from the relation:

$$\text{pH} = -\log_{10}[\text{H}^+]$$

given  $[\text{H}^+] = 1.0 \times 10^{-8} \text{ mol litre}^{-1}$

$$\text{pH} = -\log_{10} 10^{-8} = -(-8 \times \log_{10} 10)$$

$$= -(-8 \times 1) = 8$$

**Example 5:** If the pH of a solution is 4.5, what is its pOH?

**Solution:**

$$\text{pH} + \text{pOH} = 14$$

$$\text{pOH} = 14 - 4.5 = 9.5$$

$$\text{pOH} = 9.5$$

#### Points to Remember

- ❖ A chemical change is a change in which one or more new substances are formed.
- ❖ Most combination reactions are exothermic
- ❖ All photo decomposition reaction are endothermic reactions.
- ❖ Double displacement reaction or metathesis may occur by the mutual exchange of ions.
- ❖ Precipitation reaction gives an insoluble salt as the product.
- ❖ Neutralisation reactions are reactions between an acid and a base that forms salt and water.
- ❖ Neutralisation prevents tooth decay.
- ❖ Most reactions in chemistry are irreversible reactions.
- ❖ Chemical equilibrium-the rate of the forward reaction is equal to rate of the back ward reactions.
- ❖ Equilibrium is possible in a closed system.
- ❖ Temperature increases the reaction rate.
- ❖ Pressure increases the reaction rate.
- ❖ The term pH means power of hydrogen.
- ❖ pH plays a vital role in everyday life.
- ❖ In humans all bio chemical reactions take place between the pH value of 7.0 to 7.8.
- ❖ If pH of rain water is below 5.6 its called acid rain.
- ❖ Pure water is a weak electrolyte.



## TEXTBOOK EVALUATION

### I. Choose the correct answer.

- $\text{H}_{2(g)} + \text{Cl}_{2(g)} \rightarrow 2\text{HCl}_{(g)}$  is a
  - Decomposition Reaction
  - Combination Reaction
  - Single Displacement Reaction
  - Double Displacement Reaction
- Photolysis is a decomposition reaction caused by \_\_\_\_\_
  - heat
  - electricity
  - light
  - mechanical energy
- A reaction between carbon and oxygen is represented by  $\text{C}_{(s)} + \text{O}_{2(g)} \rightarrow \text{CO}_{2(g)} + \text{Heat}$ . In which of the type(s), the above reaction can be classified?
  - Combination Reaction
  - Combustion Reaction
  - Decomposition Reaction
  - Irreversible Reaction
  - i and ii
  - i and iv
  - i, ii and iii
  - i, ii and iv
- The chemical equation
 
$$\text{Na}_2\text{SO}_{4(aq)} + \text{BaCl}_{2(aq)} \rightarrow \text{BaSO}_{4(s)} \downarrow + 2\text{NaCl}_{(aq)}$$
 represents which of the following types of reaction?
  - Neutralisation
  - Combustion
  - Precipitation
  - Single displacement
- Which of the following statements are correct about a chemical equilibrium?
  - It is dynamic in nature
  - The rate of the forward and backward reactions are equal at equilibrium
  - Irreversible reactions do not attain chemical equilibrium
  - The concentration of reactants and products may be different



- i, ii and iii
  - i, ii and iv
  - ii, iii and iv
  - i, iii and iv
- A single displacement reaction is represented by  $\text{X}_{(s)} + 2\text{HCl}_{(aq)} \rightarrow \text{XCl}_{2(aq)} + \text{H}_{2(g)}$ . Which of the following(s) could be X.
    - Zn
    - Ag
    - Cu
    - Mg
 Choose the best pair.
    - i and ii
    - ii and iii
    - iii and iv
    - i and iv
  - Which of the following is not an “element + element  $\rightarrow$  compound” type reaction?
    - $\text{C}_{(s)} + \text{O}_{2(g)} \rightarrow \text{CO}_{2(g)}$
    - $2\text{K}_{(s)} + \text{Br}_{2(l)} \rightarrow 2\text{KBr}_{(s)}$
    - $2\text{CO}_{(g)} + \text{O}_{2(g)} \rightarrow 2\text{CO}_{2(g)}$
    - $4\text{Fe}_{(s)} + 3\text{O}_{2(g)} \rightarrow 2\text{Fe}_2\text{O}_{3(s)}$
  - Which of the following represents a precipitation reaction?
    - $\text{A}_{(s)} + \text{B}_{(s)} \rightarrow \text{C}_{(s)} + \text{D}_{(s)}$
    - $\text{A}_{(s)} + \text{B}_{(aq)} \rightarrow \text{C}_{(aq)} + \text{D}_{(l)}$
    - $\text{A}_{(aq)} + \text{B}_{(aq)} \rightarrow \text{C}_{(s)} + \text{D}_{(aq)}$
    - $\text{A}_{(aq)} + \text{B}_{(s)} \rightarrow \text{C}_{(aq)} + \text{D}_{(l)}$
  - The pH of a solution is 3. Its  $[\text{OH}^-]$  concentration is
    - $1 \times 10^{-3} \text{ M}$
    - 3 M
    - $1 \times 10^{-11} \text{ M}$
    - 11 M
  - Powdered  $\text{CaCO}_3$  reacts more rapidly than flaky  $\text{CaCO}_3$  because of \_\_\_\_\_.
    - large surface area
    - high pressure
    - high concentration
    - high temperature

### II. Fill in the blanks

- A reaction between an acid and a base is called \_\_\_\_\_.
- When lithium metal is placed in hydrochloric acid, \_\_\_\_\_ gas is evolved.



- The equilibrium attained during the melting of ice is known as \_\_\_\_\_.
- The pH of a fruit juice is 5.6. If you add slaked lime to this juice, its pH \_\_\_\_\_ (increase/decrease)
- The value of ionic product of water at 25<sup>o</sup> C is \_\_\_\_\_.
- The normal pH of human blood is \_\_\_\_\_
- Electrolysis is type of \_\_\_\_\_ reaction
- The number of products formed in a synthesis reaction is \_\_\_\_\_
- Chemical volcano is an example for \_\_\_\_\_ type of reaction
- The ion formed by dissolution of H<sup>+</sup> in water is called \_\_\_\_\_

### III. Match the following

1. Identify the types of reaction

REACTION	TYPE
$\text{NH}_4\text{OH}_{(aq)} + \text{CH}_3\text{COOH}_{(aq)} \rightarrow \text{CH}_3\text{COONH}_{4(aq)} + \text{H}_2\text{O}_{(l)}$	Single Displacement
$\text{Zn}_{(s)} + \text{CuSO}_{4(aq)} \rightarrow \text{ZnSO}_{4(aq)} + \text{Cu}_{(s)}$	Combustion
$\text{ZnCO}_{3(s)} \xrightarrow{\text{Heat}} \text{ZnO}_{(s)} + \text{CO}_{2(g)}$	Neutralisation
$\text{C}_2\text{H}_{4(g)} + 4\text{O}_{2(g)} \rightarrow 2\text{CO}_{2(g)} + 2\text{H}_2\text{O}_{(g)} + \text{Heat}$	Thermal decomposition

### IV. True or False: (If false give the correct statement)

- Silver metal can displace hydrogen gas from nitric acid.
- The pH of rain water containing dissolved gases like SO<sub>3</sub>, CO<sub>2</sub>, NO<sub>2</sub> will be less than 7.
- At the equilibrium of a reversible reaction, the concentration of the reactants and the products will be equal.
- Periodical removal of one of the products of a reversible reaction increases the yield.
- On dipping a pH paper in a solution, it turns into yellow. Then the solution is basic.

### V. Short answer questions:

- When an aqueous solution of potassium chloride is added to an aqueous solution of silver nitrate, a white precipitate is formed. Give the chemical equation of this reaction.
- Why does the reaction rate of a reaction increase on raising the temperature?

- Define combination reaction. Give one example for an exothermic combination reaction.
- Differentiate reversible and irreversible reactions

### VI. Answer in detail

- What are called thermolysis reactions?
- Explain the types of double displacement reactions with examples.
- Explain the factors influencing the rate of a reaction
- How does pH play an important role in everyday life?
- What is a chemical equilibrium? What are its characteristics?

### VII. HOT questions

- A solid compound 'A' decomposes on heating into 'B' and a gas 'C'. On passing the gas 'C' through water, it becomes acidic. Identify A, B and C.

2. Can a nickel spatula be used to stir copper sulphate solution? Justify your answer.

**VIII. Solve the following problems**

- Lemon juice has a pH 2, what is the concentration of H<sup>+</sup> ions?
- Calculate the pH of 1.0 × 10<sup>-4</sup> molar solution of HNO<sub>3</sub>.
- What is the pH of 1.0 × 10<sup>-5</sup> molar solution of KOH?
- The hydroxide ion concentration of a solution is 1 × 10<sup>-11</sup>M. What is the pH of the solution?



**REFERENCE BOOKS**

- Text book of inorganic chemistry-P.L.Soni-S.Chand & sons publishers, New Delhi.
- Principles of Physical Chemistry- B.R.Ruri, L.R. Sharma, Vishal publishing Co Punjab.



**INTERNET RESOURCES**

Webliography:www.chem4kids.com  
<http://aravindguptatoys.com/filims.html>

**Concept Map**

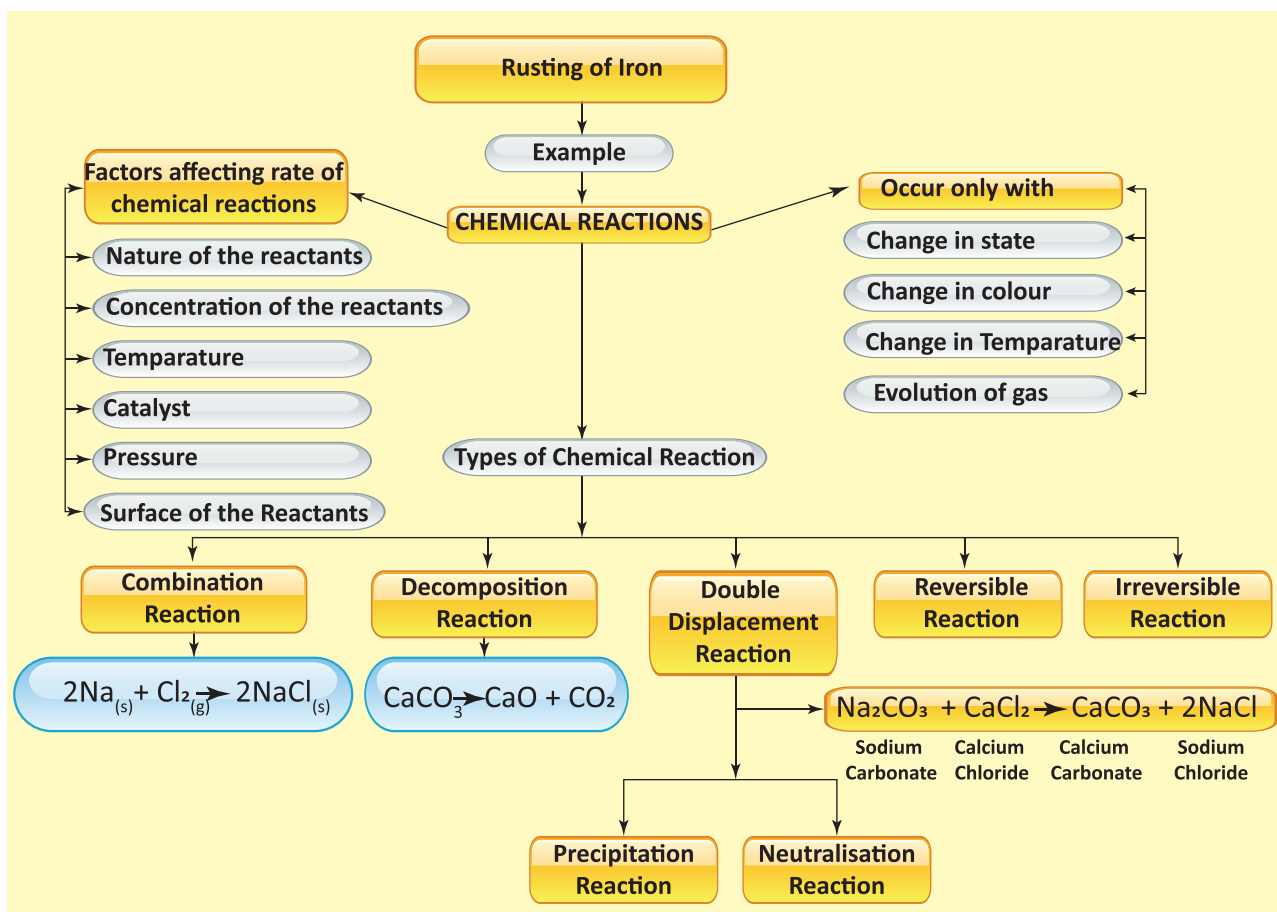

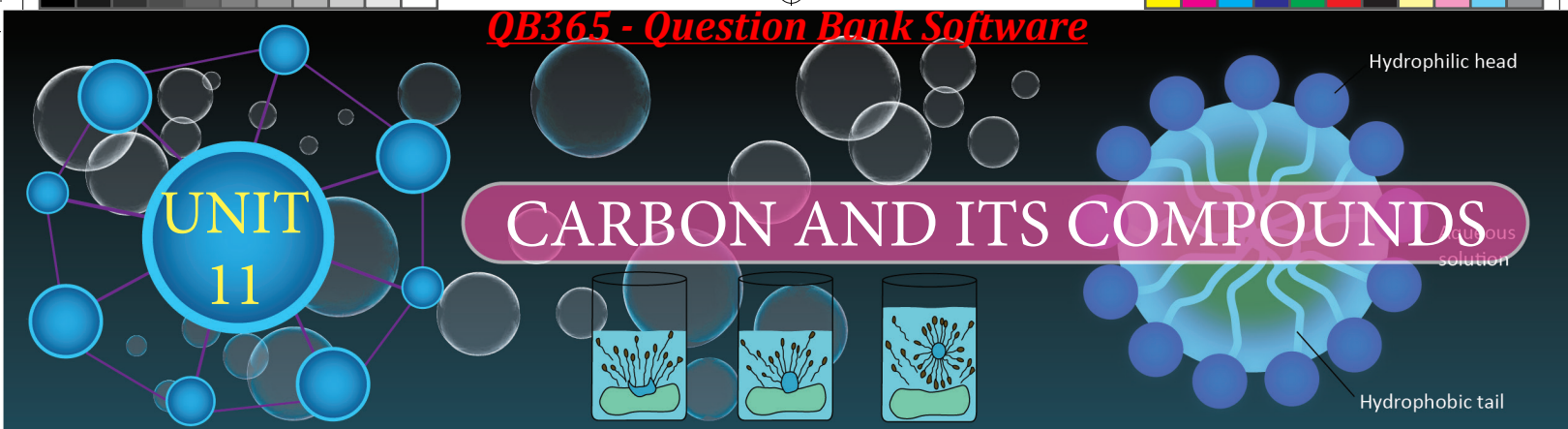

## Learning Objectives



HV8C7L

After studying this lesson, the student will be able to:

- ◆ know the importance of organic compounds.
- ◆ classify the organic compounds and name them based on IUPAC rules.
- ◆ identify the functional groups of organic compounds.
- ◆ explain the preparation, properties and uses of ethanol and ethanoic acids.
- ◆ know the composition and preparation of soap and detergent.
- ◆ understand the cleansing action of soap and detergents.
- ◆ differentiate soap and detergents.

## INTRODUCTION

You have studied, in your lower classes, that carbon is an inseparable element in human life as we use innumerable number of carbon compounds in our day to day life. Because, the food we eat, medicines we take when ill, clothes we wear; domestic and automobile fuels, paint, cosmetics, automobile parts, etc., that we use contain carbon compounds. The number of carbon compounds found in nature and man-made, is much higher than that of any other element in the periodic table. Infact there are more than 5 million compounds of carbon. The unique nature of carbon, such as catenation, tetravalency and multiple bonding, enables it to combine with itself or other elements like hydrogen, oxygen, nitrogen, sulphur etc., and hence form large number of compounds. All these compounds are made of covalent bonds. These compounds

are called **organic compounds**. In this lesson, you will learn about carbon compounds.

### 11.1 GENERAL CHARACTERISTICS OF ORGANIC COMPOUNDS

Everything in this world has unique character, similarly organic compounds are unique in their characteristics. Some of them are given below:

- ◆ Organic compounds have a high molecular weight and a complex structure.
- ◆ They are mostly insoluble in water, but soluble in organic solvents such as ether, carbon tetrachloride, toluene, etc.
- ◆ They are highly inflammable in nature
- ◆ Organic compounds are less reactive compared to inorganic compounds. Hence, the reactions involving organic compounds proceed at slower rates.

- ◆ Mostly organic compounds form covalent bonds in nature.
- ◆ They have lower melting point and boiling point when compared to inorganic compounds
- ◆ They exhibit the phenomenon of isomerism, in which a single molecular formula represents several organic compounds that differ in their physical and chemical properties
- ◆ They are volatile in nature.
- ◆ Organic compounds can be prepared in the laboratory

## 11.2 CLASSIFICATION OF ORGANIC COMPOUNDS BASED ON THE PATTERN OF CARBON CHAIN

What is the significance of classification? There are millions of organic compounds known and many new organic compounds are discovered every year in nature or synthesized in laboratory. This may mystify organic chemistry to a large extent. However, a unique molecular structure can be assigned to each compound and it can be listed by using systematic methods of classification and eventually named on the basis of its structural arrangements. In early days, chemists recognised that compounds having similar structural features have identical chemical properties. So they began to classify compounds based on the common structural arrangements found among them.

Organic chemistry is the chemistry of catenated carbon compounds. The carbon atoms present in organic compounds are linked with each other through covalent bonds and thus exist as chains. By this way, organic compounds are classified into two types as follows:

**1. Acyclic or Open chain compounds:** These are the compounds in which the carbon

atoms are linked in a linear pattern to form the chain. If all the carbon atoms in the chain are connected by single bonds, the compound is called as **saturated**. If one or more double bonds or triple bonds exist between the carbon atoms, then the compound is said to be **unsaturated**.

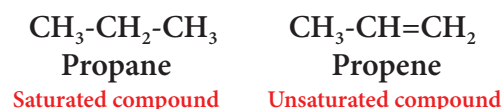

**2. Cyclic Compounds:** Organic compounds in which the chain of carbon atoms is closed or cyclic are called **cyclic compounds**. If the chain contains only carbon atoms, such compounds are called **carbocyclic** (Homocyclic) **compounds**. If the chain contains carbon and other atoms like oxygen, nitrogen, sulphur, etc., these compounds are called **heterocyclic compounds**. Carbocyclic compounds are further subdivided into **alicyclic** and **aromatic compounds**. Alicyclic compounds contain one or more carbocyclic rings which may be saturated or unsaturated whereas aromatic compounds contain one or more benzene rings (ring containing alternate double bonds between carbon atoms). E.g.

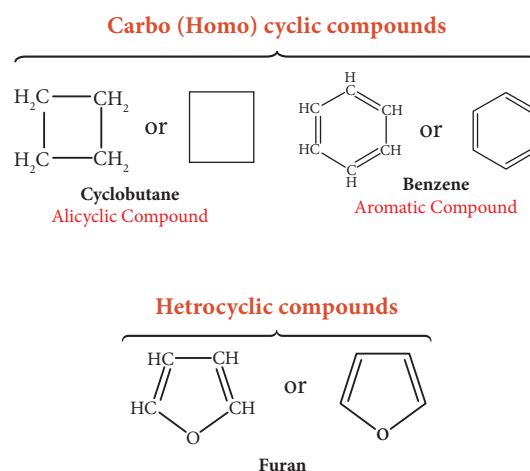

Figure 11.1 depicts the classification of organic compounds based on the pattern of carbon arrangements and their bonding in organic compounds:

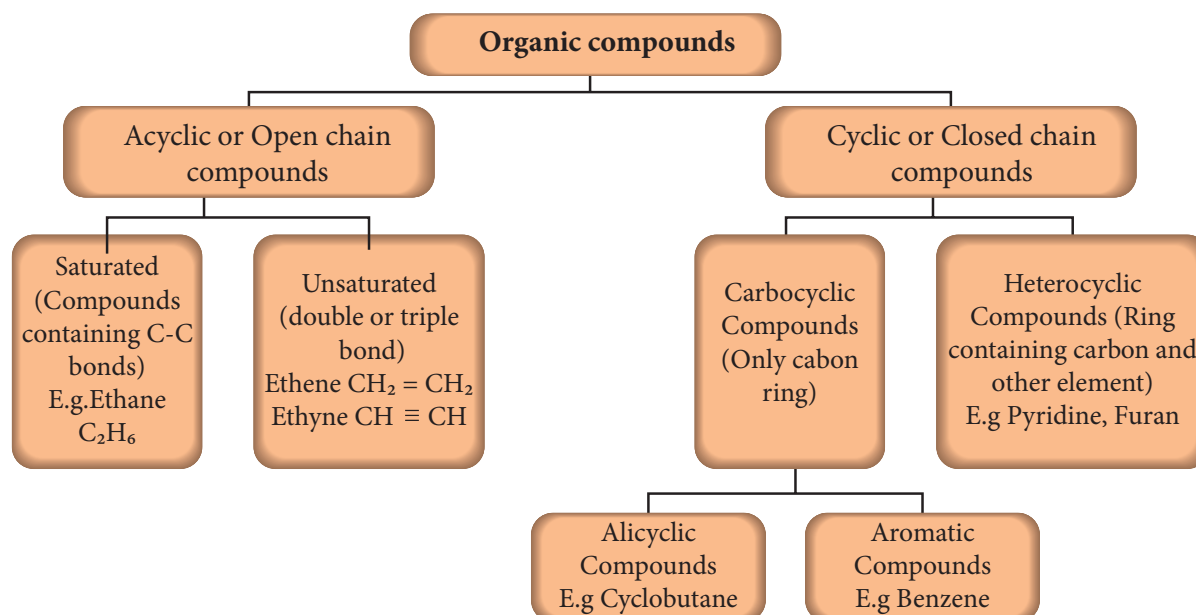

Figure 11.1 Classification of organic compounds

### 11.3 CLASSES OF ORGANIC COMPOUNDS (BASED ON THE KIND OF ATOMS)

Other than carbon, organic compounds contain atoms like hydrogen, oxygen, nitrogen, etc., bonded to the carbon. Combination of these kinds of atoms with carbon gives different classes of organic compounds. In the following section, let us discuss various classes of organic compounds.

#### 11.3.1 Hydrocarbons

The organic compounds that are composed of only carbon and hydrogen atoms are called **hydrocarbons**. The carbon atoms join together to form the framework of the compounds. These are regarded as the parent organic compounds and all other compounds are considered to be derived from hydrocarbons by replacing one or more hydrogen atoms with other atoms or group of atoms. Hydrocarbons are, further, subdivided into three classes such as:

(a) **Alkanes:** These are hydrocarbons, which contain only single bonds. They are represented by the general formula  $C_nH_{2n+2}$  (where  $n = 1, 2, 3, \dots$ ). The simplest alkane (for  $n=1$ ) is methane ( $CH_4$ ). Since, all are single bonds in alkanes, they are saturated compounds.

(b) **Alkenes:** The hydrocarbons, which contain one or more  $C=C$  bonds are called alkenes. These are unsaturated compounds. They are represented by the general formula  $C_nH_{2n}$ . The simplest alkene contains two carbon atoms ( $n=2$ ) and is called ethylene ( $C_2H_4$ ).

(c) **Alkynes:** The hydrocarbons containing carbon to carbon triple bond are called **alkynes**. They are also unsaturated as they contain triple bond between carbon atoms. They have the general formula  $C_nH_{2n-2}$ . Acetylene ( $C_2H_2$ ) is the simplest alkyne, which contains two carbon atoms. Table 11.1 lists the first five hydrocarbons of each class:

Table 11.1 Hydrocarbons containing 1 to 5 carbon atoms

No. of carbon atoms	Alkane ( $C_nH_{2n+2}$ )	Alkene ( $C_nH_{2n}$ )	Alkyne ( $C_nH_{2n-2}$ )
1	Methane ( $CH_4$ )	-	-
2	Ethane ( $C_2H_6$ )	Ethene ( $C_2H_4$ )	Ethyne ( $C_2H_2$ )
3	Propane ( $C_3H_8$ )	Propene ( $C_3H_6$ )	Propyne ( $C_3H_4$ )
4	Butane ( $C_4H_{10}$ )	Butene ( $C_4H_8$ )	Butyne ( $C_4H_6$ )
5	Pentane ( $C_5H_{12}$ )	Pentene ( $C_5H_{10}$ )	Pentyne ( $C_5H_8$ )

### 11.3.2 Characteristics of hydrocarbons:

- ◆ Lower hydrocarbons are gases at room temperature E.g. methane, ethane are gases.
- ◆ They are colourless and odourless.
- ◆ The boiling point of hydrocarbons increases with an increase in the number of carbon atoms.
- ◆ They undergo combustion reaction with oxygen to form  $\text{CO}_2$  and water.
- ◆ Alkanes are least reactive when compared to other classes of hydrocarbons.
- ◆ Alkynes are the most reactive due to the presence of the triple bond.
- ◆ Alkanes are saturated whereas alkenes and alkynes are unsaturated.
- ◆ They are insoluble in water.

#### Test to identify saturated and unsaturated compounds:

- ◆ Take the given sample solution in a test tube.
- ◆ Add a few drops of bromine water and observe any characteristic change in colour.
- ◆ If the given compound is unsaturated, it will decolourise bromine water.
- ◆ Saturated compounds do not decolourise bromine.

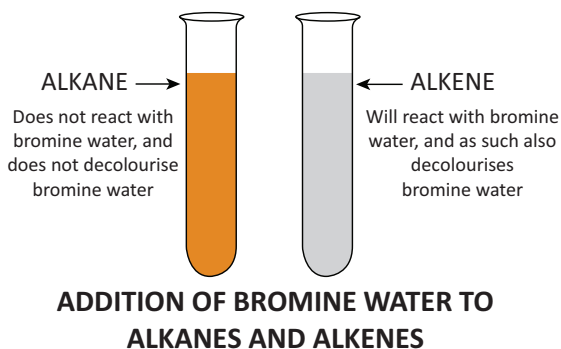

Figure 11.2 Test to identify unsaturated compounds

### 11.3.3 Classification of organic compounds based on functional groups

The structural frameworks of organic compounds are made of carbon and hydrogen, which are relatively less reactive. But, the presence of some other atoms or group of atoms makes the compounds more reactive and thus determines the chemical properties of the compound. These groups are called **functional groups**.

**A functional group is an atom or group of atoms in a molecule, which gives its characteristic chemical properties.**

The chemical properties of an organic compound depend on its functional group whereas its physical properties rely on remaining part of the structure. Carbon to carbon multiple bonds ( $\text{C}=\text{C}$ ,  $\text{C}\equiv\text{C}$ ) also are considered as functional groups as many of the properties are influenced by these bonds. Other functional groups include,  $-\text{OH}$ ,  $-\text{CHO}$ ,  $-\text{COOH}$ , etc.

For example, ethane is a hydrocarbon having molecular formula  $\text{C}_2\text{H}_6$ . If one of its hydrogen is replaced by  $-\text{OH}$  group, you will get an alcohol. Leaving the functional group, the rest of the structure is represented by 'R'. Thus an alcohol is represented by 'R-OH'

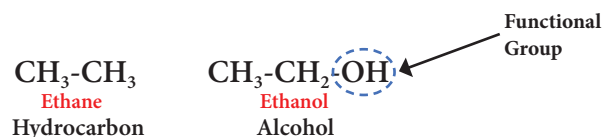

A series of compounds containing the same functional group is called a **class of organic compounds**. Table 11.2 shows various classes or families of organic compounds and their functional groups:

Table 11.2 Classes of organic compounds based on functional group

Class of the compound	Functional group	Common Formula	Examples
Alcohol	-OH	R-OH	Ethanol, CH <sub>3</sub> CH <sub>2</sub> OH
Aldehyde	$\begin{array}{c} \text{O} \\    \\ -\text{C}-\text{H} \end{array}$	R-CHO	Acetaldehyde, CH <sub>3</sub> CHO
Ketone	$\begin{array}{c} \text{O} \\    \\ -\text{C}- \end{array}$	R-CO-R	Acetone, CH <sub>3</sub> COCH <sub>3</sub>
Carboxylic acid	$\begin{array}{c} \text{O} \\    \\ -\text{C}-\text{OH} \end{array}$	R-COOH	Acetic acid, CH <sub>3</sub> COOH
Ester	$\begin{array}{c} \text{O} \\    \\ -\text{C}-\text{OR} \end{array}$	R-COOR	Methyl acetate, CH <sub>3</sub> COOCH <sub>3</sub>
Ether	-O-R	R-O-R	Dimethyl ether, CH <sub>3</sub> OCH <sub>3</sub>

## 11.4 HOMOLOGOUS SERIES

**Homologous series** is a group or a class of organic compounds having same general formula and similar chemical properties in which the successive members differ by a -CH<sub>2</sub> group.

Let us consider members of alkanes given in Table 11.1. Their condensed structural formulas are given below:

Methane	-	CH <sub>4</sub>
Ethane	-	CH <sub>3</sub> CH <sub>3</sub>
Propane	-	CH <sub>3</sub> CH <sub>2</sub> CH <sub>3</sub>
Butane	-	CH <sub>3</sub> (CH <sub>2</sub> ) <sub>2</sub> CH <sub>3</sub>
Pentane	-	CH <sub>3</sub> (CH <sub>2</sub> ) <sub>3</sub> CH <sub>3</sub>

If you observe the above series, you can notice that each successive member has one methylene group more than the precedent member of the series and hence they are called homologs.

### 11.4.1 Characteristics of homologous series

- ◆ Each member of the series differs from the preceding or succeeding member by one methylene group (-CH<sub>2</sub>) and hence by a molecular mass of 14 amu.
- ◆ All members of a homologous series contain the same elements and functional group.
- ◆ They are represented by a general molecular formula. e.g. Alkanes, C<sub>n</sub>H<sub>2n+2</sub>.
- ◆ The members in each homologous series show a regular gradation in their physical properties with respect to their increase in molecular mass.
- ◆ Chemical properties of the members of a homologous series are similar.
- ◆ All the members can be prepared by a common method.

## 11.5 NOMENCLATURE OF ORGANIC COMPOUNDS

### 11.5.1 Why do we need nomenclature?

In ancient days, the names of organic compounds were related to the natural things from which they were obtained. For example, the formic acid was initially obtained by distillation of 'red ants'. Latin name of the red ant is 'Formica'. So, the name of the formic acid was derived from the Latin name of its source. Later, the organic compounds were synthesized from sources other than the natural sources. So scientists framed a systematic method for naming the organic compounds based on their structures. Hence, a set of rules was formulated by IUPAC (**I**nternational **U**nion of **P**ure and **A**ppplied **C**hemistry) for the nomenclature of chemical compounds.

### 11.5.2 Components of an IUPAC name

The IUPAC name of the any organic compound consists of three parts:

- i. Root word
- ii. Prefix
- iii. Suffix

These parts are combined as per the following sequence to get the IUPAC name of the compound:



(i) **Root word:** It is the basic unit, which describes the carbon skeleton. It gives the number of carbon atoms present in the parent chain of the compound and the pattern of their arrangement. Based on the number of carbon atoms present in the carbon skeleton, most of the names are derived from Greek numerals (except the first four). Table 11.3 shows the root words for the parent chain of hydrocarbons containing 1 to 10 carbon atoms:

Table 11.3 Root words of hydrocarbons

No. of carbon atoms	Root word
1	Meth-
2	Eth-
3	Prop-
4	But-
5	Pent-
6	Hex-
7	Hept-
8	Oct-
9	Non-
10	Dec-

(ii) **Prefix:** The prefix represents the substituents or branch present in the parent chain. Atoms or group of atoms, other than hydrogen, attached to carbon of the parent chain are called substituents. Table 11.4 presents the major substituents of organic compounds and respective prefix used for them:

Table 11.4 Prefix for IUPAC Name

Substituent	Prefix used
-F	Fluoro
-Cl	Chloro
-Br	Bromo
-I	Iodo
-NH <sub>2</sub>	Amino
-CH <sub>3</sub>	Methyl
-CH <sub>2</sub> CH <sub>3</sub>	Ethyl

### (iii) Suffix

The suffix forms the end of the name. It is divided into two parts such as (a) **Primary suffix** and (b) **Secondary suffix**. The primary suffix comes after the root word. **It represents the nature in carbon to carbon bonding of the parent chain.** If all the bonds between the carbon atoms of the parent chain are single, then suffix 'ane' has to be used. Suffix 'ene' and 'yne' are used for the compounds containing double



and triple bonds respectively. The secondary suffix describes the functional group of the compound.

Table 11.5 Suffix for IUPAC Name

Class of the Compound	Functional group	Suffix used
Alcohol	-OH	-ol
Aldehyde	-CHO	-al
Ketone	$\begin{array}{c} \text{O} \\    \\ -\text{C}- \end{array}$	-one
Carboxylic acid	-COOH	-oic acid

### 11.5.3 IUPAC rules for naming organic compounds:

- ◆ **Rule 1:** Identify the longest chain of carbon atoms to get the parent name (root word).
- ◆ **Rule 2:** Number the carbon atoms of the parent chain, **beginning at the closest end of the substituent or functional group**. These are called **locant numbers**. *If both functional group and substituent are present, then the priority will be given to the functional group.*
- ◆ **Rule 3:** In case of alkenes and alkynes, locate the double bond or triple bond and use its locant number followed by a dash and a primary suffix. The carbon chain is numbered in such a way that the multiple bonds have the lowest possible locant number.
- ◆ **Rule 4:** If the compound contains functional group, locate it and use its locant number followed by a dash and a secondary suffix.
- ◆ **Rule 5:** When the primary and secondary suffixes are joined, the terminal 'e' of the primary suffix is removed.
- ◆ **Rule 6:** Identify the substituent and use a number followed by a dash and a prefix to

specify its location and identity.

### 11.5.4 IUPAC Nomenclature of hydrocarbons – Solved examples

Let us try to name, systematically, some of the linear and substituted hydrocarbons by following IUPAC rules:

**Example 1:**  $\text{CH}_3\text{-CH}_2\text{-CH}_2\text{-CH}_2\text{-CH}_3$

Step 1: It is a five- carbon chain and hence the root word is 'Pent'. (Rule 1)

Step 2: All the bonds between carbon atoms are single bonds, and thus the suffix is 'ane'.

So, its name is **Pent + ane = Pentane**

**Example 2:**

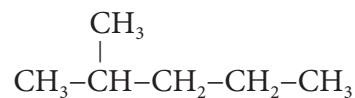

**Step 1:** The longest chain contains five carbon atoms and hence the root word is 'Pent'.

**Step 2:** There is a substituent. So, the carbon chain is numbered from the left end, which is closest to the substituent. (Rule 2)

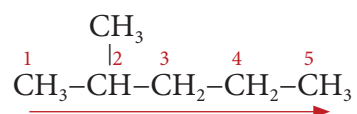

**Step 3:** All are single bonds between the carbon atoms and thus the suffix is 'ane'.

**Step 4:** The substituent is a methyl group and it is located at second carbon atom. So, its locant number is 2. Thus the prefix is '2-Methyl'. (Rule 6).

The name of the compound is  
**2-Methyl + pent +ane = 2-Methylpentane**

**Example 3:**

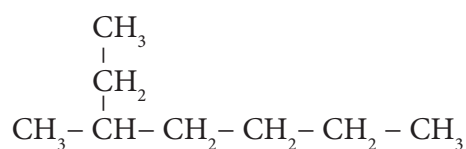

**Step 1:** The longest chain contains seven carbon atoms and hence the root word is 'Hept'.

**Step 2:** There is a substituent. So, the

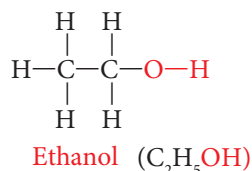

Table 11.6 IUPAC Name of various classes of compounds

No. of carbons atoms	IUPAC Name			
	Alcohols	Aldehydes	Ketones	Carboxylic acid
1	Methanol (CH <sub>3</sub> OH)	Methanal (HCHO)	-	Methanoic acid (HCOOH)
2	Ethanol (CH <sub>3</sub> CH <sub>2</sub> OH)	Ethanal (CH <sub>3</sub> CHO)	-	Ethanoic acid (CH <sub>3</sub> COOH)
3	Propanol (CH <sub>3</sub> CH <sub>2</sub> CH <sub>2</sub> OH)	Propanal (CH <sub>3</sub> CH <sub>2</sub> CHO)	Propanone (CH <sub>3</sub> COCH <sub>3</sub> )	Propanoic acid (CH <sub>3</sub> CH <sub>2</sub> COOH)
4	Butanol (CH <sub>3</sub> CH <sub>2</sub> CH <sub>2</sub> CH <sub>2</sub> OH)	Butanal (CH <sub>3</sub> CH <sub>2</sub> CH <sub>2</sub> CHO)	Butanone (CH <sub>3</sub> COCH <sub>2</sub> CH <sub>3</sub> )	Butanoic acid (CH <sub>3</sub> CH <sub>2</sub> CH <sub>2</sub> COOH)
5	Pentanol (CH <sub>3</sub> CH <sub>2</sub> CH <sub>2</sub> CH <sub>2</sub> CH <sub>2</sub> OH)	Pentanal (CH <sub>3</sub> CH <sub>2</sub> CH <sub>2</sub> CH <sub>2</sub> CHO)	Pentanone (CH <sub>3</sub> COCH <sub>2</sub> CH <sub>2</sub> CH <sub>3</sub> )	Pentanoic acid (CH <sub>3</sub> CH <sub>2</sub> CH <sub>2</sub> CH <sub>2</sub> COOH)

## 11.6 ETHANOL (CH<sub>3</sub>CH<sub>2</sub>OH)

Ethanol is commonly known as alcohol. All alcoholic beverages and some cough syrups contain ethanol. Its molecular formula is C<sub>2</sub>H<sub>5</sub>OH. Its structural formula is



### 11.6.1 Manufacture of ethanol

Ethanol is manufactured in industries by the fermentation of molasses, which is a by-product obtained during the manufacture of sugar from sugarcane. Molasses is a dark coloured syrupy liquid left after the crystallization of sugar from the concentrated sugarcane juice. Molasses contain about 30% of sucrose, which cannot be separated by crystallization. It is converted into ethanol by the following steps:

#### (i) Dilution of molasses

Molasses is first diluted with water to bring down the concentration of sugar to about 8 to 10 percent.

#### (ii) Addition of Nitrogen source

Molasses usually contains enough nitrogenous matter to act as food for yeast during the fermentation process. If the nitrogen content of the molasses is poor, it may be fortified by the addition of **ammonium sulphate** or **ammonium phosphate**.

#### (iii) Addition of Yeast

The solution obtained in step (ii) is collected in large 'fermentation tanks' and yeast is added to it. The mixture is kept at about 303K for a few days. During this period, the enzymes invertase and zymase present in yeast, bring about the conversion of sucrose into ethanol.

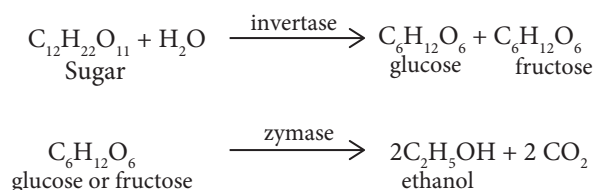

The fermented liquid is technically called **wash**.

#### (iv) Distillation of 'Wash'

The fermented liquid (i.e. wash), containing 15 to 18 percent alcohol, is now subjected to fractional distillation. The main fraction drawn is an aqueous solution of ethanol which contains

95.5% of ethanol and 4.5% of water. This is called **rectified spirit**. This mixture is then refluxed over quicklime for about 5 to 6 hours and then allowed to stand for 12 hours. On distillation of this mixture, pure alcohol (100%) is obtained. This is called **absolute alcohol**.

### More to know

**Yeast and Fermentation:** Yeasts are single-celled microorganisms, belonging to the class of fungi. The enzymes present in yeasts catalyse many complex organic reactions. Fermentation is conversion of complex organic molecules into simpler molecules by the action of enzymes. E.g. Curdling of milk

### 11.6.2 Physical properties

- Ethanol is a colourless liquid, having a pleasant smell and a burning taste.
- It is a volatile liquid. Its boiling point is 78° C (351K), which is much higher than that of its corresponding alkane, i.e. ethane (Boiling Point = 184 K).
- It is completely miscible with water in all proportions.

### 11.6.3 Chemical Properties

#### (i) Dehydration (Loss of water)

When ethanol is heated with con  $\text{H}_2\text{SO}_4$  at 443K, it loses a water molecule i.e. dehydrated to form ethene.

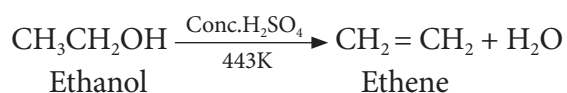

#### (ii) Reaction with sodium:

Ethanol reacts with sodium metal to form sodium ethoxide and hydrogen gas.



#### (iii) Oxidation:

Ethanol is oxidized to ethanoic acid with alkaline  $\text{KMnO}_4$  or acidified  $\text{K}_2\text{Cr}_2\text{O}_7$

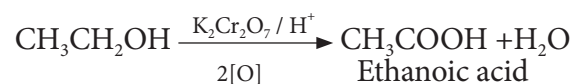

During this reaction, the orange colour of  $\text{K}_2\text{Cr}_2\text{O}_7$  changes to green. Therefore, this reaction can be used for the identification of alcohols.

#### (iv) Esterification:

The reaction of an alcohol with a carboxylic acid gives a compound having fruity odour. This compound is called an **ester** and the reaction is called esterification. Ethanol reacts with ethanoic acid in the presence of conc.  $\text{H}_2\text{SO}_4$  to form ethyl ethanoate, an ester.

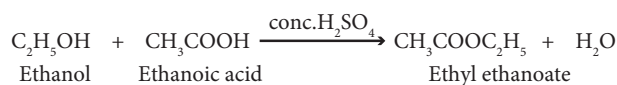

#### (v) Dehydrogenation:

When the vapour of ethanol is passed over heated copper, used as a catalyst at 573 K, it is dehydrogenated to acetaldehyde.

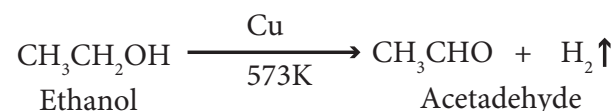

#### (vi) Combustion:

Ethanol is highly inflammable liquid. It burns with oxygen to form carbon dioxide and water.

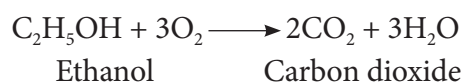

### 11.6.4 Uses of ethanol

Ethanol is used

- ◆ in medical wipes, as an antiseptic.
- ◆ as an anti-freeze in automobile radiators.
- ◆ for effectively killing micro organisms like bacteria, fungi, etc., by including it in many hand sanitizers.

- ◆ as an antiseptic to sterilize wounds in hospitals.
- ◆ as a solvent for drugs, oils, fats, perfumes, dyes, etc.
- ◆ in the preparation of **methylated spirit** (mixture of 95% of ethanol and 5% of methanol) **rectified spirit** (mixture of 95.5% of ethanol and 4.5% of water), power alcohol (mixture of petrol and ethanol) and denatured spirit (ethanol mixed with pyridine).
- ◆ to enhance the flavour of food extracts, for example vanilla extract; a common food flavour, which is made by processing vanilla beans in a solution of ethanol and water.

## 11.7 ETHANOIC ACID (CH<sub>3</sub>COOH)

Ethanoic acid or acetic acid is one of the most important members of the carboxylic acid family. Its molecular formula is C<sub>2</sub>H<sub>4</sub>O<sub>2</sub>. Its structural formula is

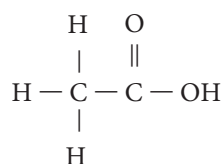

### 11.7.1 Manufacture of ethanoic acid

Ethanoic acid is prepared in large scale, by the oxidation of ethanol in the presence of alkaline potassium permanganate or acidified potassium dichromate.

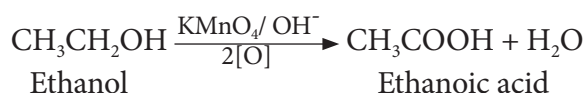

### 11.7.2 Physical Properties

- (i) Ethanoic acid is a colourless liquid having an unpleasant odour.

- (ii) It is sour in taste.
- (iii) It is miscible with water in all proportions.
- (iv) Its boiling point is higher than the corresponding alcohols, aldehydes and ketones.
- (v) On cooling, pure ethanoic acid is frozen to form ice like flakes. They look like glaciers, so it is called **glacial acetic acid**.

### 11.7.3 Chemical Properties

- (i) **Reaction with metal:** Ethanoic acid reacts with active metals like Na, Zn, etc., to liberate hydrogen and form their ethanoate.

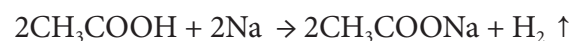
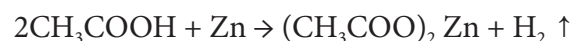

- (ii) **Reaction with carbonates and bicarbonates:** Ethanoic acid reacts with sodium carbonate and sodium bicarbonate, which are weaker bases and liberates CO<sub>2</sub>, with brisk effervescence.

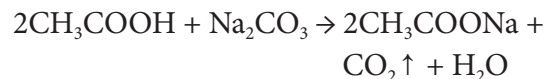

- (iii) **Reaction with base:** Ethanoic acid reacts with sodium hydroxide to form sodium ethanoate and water.

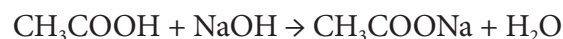

- (iv) **Decarboxylation (Removal of CO<sub>2</sub>):**

When a sodium salt of ethanoic acid is heated with soda lime (solid mixture of 3 parts of NaOH and 1 part of CaO), methane gas is formed.

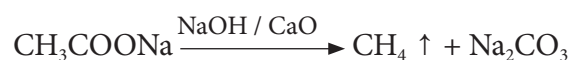

### 11.7.4 Uses of ethanoic acid

Acetic acid, in lower concentration, (vinegar) is used as a food additive, a flavoring agent and a preservative.

**Ethanoic acid is used**

- ◆ in the manufacture of plastic.
- ◆ in making dyes, pigments and paint.
- ◆ in printing on fabrics.
- ◆ as a laboratory reagent.
- ◆ for coagulating rubber from latex.
- ◆ in the production of pharmaceuticals.

## 11.8 ORGANIC COMPOUNDS IN DAILY LIFE

Organic compounds are inseparable in human life. They are used by mankind or associated at all stages of life right from one's birth to death. Various classes of organic compounds and their uses in our daily life as follows:

**Hydrocarbons**

- ◆ Fuels like LPG, Petrol, Kerosene.
- ◆ Raw materials for various important synthetic materials.
- ◆ Polymeric materials like tyre, plastic containers.

**Alcohols**

- ◆ As a solvent and an antiseptic agent.
- ◆ Raw materials for various important synthetic materials.

**Aldehydes**

- ◆ Formaldehyde as a disinfectant.
- ◆ Raw materials for synthetic materials.

**Ketones**

- ◆ As a solvent.
- ◆ Stain Remover.

**Ethers**

- ◆ Anaesthetic agents.
- ◆ Pain Killer.

**Esters**

- ◆ All the cooking oils and lipids contain esters.

## 11.9 SOAPS AND DETERGENTS

Soaps and the Detergents are materials that are used by us for cleaning purposes because pure water alone cannot remove all types of dirt or any oily substance from our body or clothes. They contain 'surfactants', which are compounds with molecules that line up around water to break the 'surface tension'. Both of them having a different chemical nature. **Soap** is a cleaning agent that is composed of one or more salts of fatty acids. **Detergent** is a chemical compound or a mixture of chemical compounds, which is used as a cleaning agent, also. They perform their cleaning actions in certain specific conditions. You will learn more about this in detail, in the following units.

### 11.9.1 Soap

**Soaps are sodium or potassium salts of some long chain carboxylic acids, called fatty acids.** Soap requires two major raw materials: i) fat and ii) alkali. The alkali, most commonly used in the preparation of soap is sodium hydroxide. Potassium hydroxide can also be used. A potassium-based soap creates a more water-soluble product than a sodium-based soap. Based on these features, there are two types of soaps:

#### A. HARD SOAP

Soaps, which are prepared by the **saponification of oils or fats with caustic soda** (sodium hydroxide), are known as hard soaps. They are usually used for washing purposes.

#### B. SOFT SOAP

Soaps, which are prepared by the **saponification of oils or fats with potassium salts**, are known as soft soaps. They are used for cleansing the body.

### Manufacture of soap

#### KETTLE PROCESS:

This is the oldest method. But, it is still widely used in the small scale preparation of

soap. There are mainly, two steps to be followed in this process.

#### i) Saponification of oil:

The oil, which is used in this process, is taken in an iron tank (kettle). The alkaline solution (10%) is added into the kettle, a little in excess. The mixture is boiled by passing steam through it. The oil gets hydrolysed after several hours of boiling. This process is called Saponification

#### ii) Salting out of soap:

Common salt is then added to the boiling mixture. Soap is finally precipitated in the tank. After several hours the soap rises to the top of the liquid as a 'curdy mass'. The neat soap is taken off from the top. It is then allowed to cool down.

### Effect of hard water on soap

Hard water contains calcium and magnesium ions ( $\text{Ca}^{2+}$  and  $\text{Mg}^{2+}$ ) that limit the cleaning action of soap. When combined with soap, hard water develops a thin layer (precipitates of the metal ions) called 'scum', which leaves a deposit on the clothes or skin and does not easily rinse away. Over time, this can lead to the deterioration of the fabric and eventually ruin the clothes. On the other hand, detergents are made with chemicals that are not affected by hard water.



**Why ordinary soap is not suitable for using with hard water?**

Ordinary soaps when treated with hard water, precipitate as salts of calcium and magnesium. **They appear at the surface of the cloth as sticky grey scum.** Thus, the soaps cannot be used conveniently in hard water.

### 11.9.2 Detergents

Development of synthetic detergents is a big achievement in the field of cleansing.

These soaps possess the desirable properties of ordinary soaps and also can be used with hard water and in acidic solutions. These are salts of sulphonic acids or alkyl hydrogen sulphates in comparison to soap, which are salts of carboxylic acids. The detergents do not form precipitates with  $\text{Ca}^{2+}$  and  $\text{Mg}^{2+}$  present in hard water. So, the cleansing action of detergents is better than that of soaps.

### Preparation of detergents

Detergents are prepared by adding sulphuric acid to the processed hydrocarbon obtained from petroleum. This chemical reaction results in the formation of molecules similar to the fatty acid in soap. Then, an alkali is added to the mixture to produce the 'surfactant molecules', which do not bond with the minerals present in the hard water, thus preventing the formation of their precipitates.

In addition to a 'surfactant', the modern detergent contains several other ingredients. They are listed as follows:

- i) Sodium silicate, which prevents the corrosion and ensures that the detergent does not damage the washing machine.
- ii) Fluorescent whitening agents that give a glow to the clothes.
- iii) Oxygen bleaches, such as 'sodium perborate', enable the removal of certain stains from the cloth.
- iv) Sodium sulphate is added to prevent the caking of the detergent powder.
- v) Enzymes are added to break down some stains caused by biological substances like blood and vegetable juice.
- vi) Certain chemicals that give out a pleasant smell are also added to make the clothes fragrant after they are washed with detergents.

### 11.9.3 Cleansing action of soap

A soap molecule contains two chemically distinct parts that interact differently with

water. It has one **polar end**, which is a **short head** with a carboxylate group ( $-\text{COONa}$ ) and one **non-polar end** having the **long tail made of the hydrocarbon chain**.



The polar end is **hydrophilic (Water loving)** in nature and this end is attracted towards water. The non-polar end is **hydrophobic (Water hating)** in nature and it is attracted towards dirt or oil on the cloth, but not attracted towards water. Thus, the hydrophobic part of the soap molecule traps the dirt and the hydrophilic part makes the entire molecule soluble in water.

When a soap or detergent is dissolved in water, the molecules join together as clusters called '**micelles**'. Their long hydrocarbon chains attach themselves to the oil and dirt. The dirt is thus surrounded by the non-polar end of the soap molecules (Figure 11.3). The charged carboxylate end of the soap molecules makes the micelles soluble in water. Thus, the dirt is washed away with the soap.

#### Advantages of detergents over soaps

Detergents are better than soaps because they:

- can be used in both hard and soft water and can clean more effectively in hard water than soap.
- can also be used in saline and acidic water.
- do not leave any soap scum on the tub or clothes.
- dissolve freely even in cool water and rinse freely in hard water.
- can be used for washing woollen garments, where as soap cannot be used.
- have a linear hydrocarbon chain, which is biodegradable.
- are active emulsifiers of motor grease.

- do an effective and safe cleansing, keeping even synthetic fabrics brighter and whiter.

#### Biodegradable and Non-biodegradable detergents:

##### a) Biodegradable detergents:

They have straight hydrocarbon chains, which can be easily degraded by bacteria.

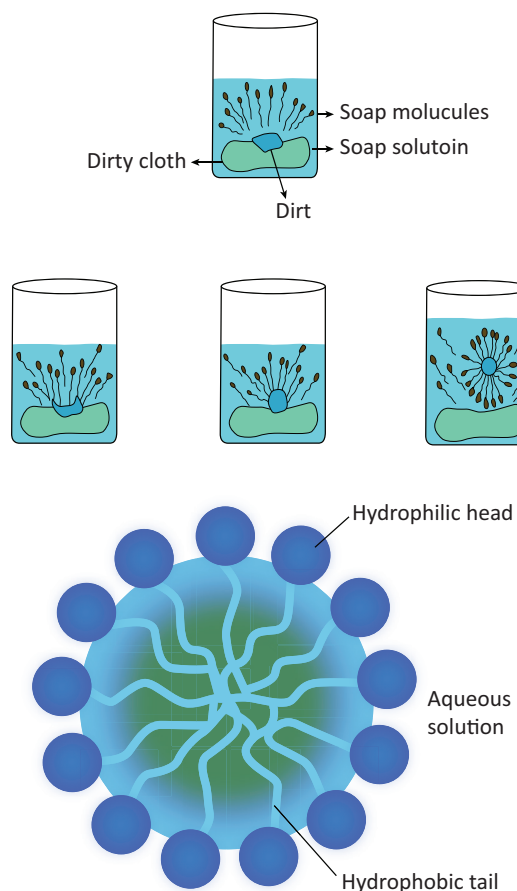

Figure 11.3 Cleansing action of soap

##### b) Non-biodegradable detergents:

They have highly branched hydrocarbon chains, which cannot be degraded by bacteria.

#### Disadvantages of Detergents

1. Some detergents having a branched hydrocarbon chain are not fully biodegradable by micro-organisms present in water. So, they cause water pollution.
2. They are relatively more expensive than soap.



### 11.9.4 Comparison between soap and detergents

Soap	Detergent
It is a sodium salt of long chain fatty acids.	It is sodium salts of sulphonic acids.
The ionic part of a soap is $\text{-COO}^-\text{Na}^+$ .	The ionic part in a detergent is $\text{-SO}_3^-\text{Na}^+$ .
It is prepared from animal fats or vegetable oils.	It is prepared from hydrocarbons obtained from crude oil.
Its effectiveness is reduced when used in hard water.	It is effective even in hard water.
It forms a scum in hard water.	Does not form a scum in hard water.
It has poor foaming capacity.	It has rich foaming capacity.
Soaps are biodegradable.	Most of the detergents are non-biodegradable.

#### Have you noticed the term "TFM" in soap



**TFM means** TOTAL FATTY MATTER. It is the one of the important factors to be considered to assess the quality of soap. A soap, which has higher TFM, is a good bathing soap.

#### Points to Remember

- ❖ A group or class of organic compounds related to each other by a general molecular formula constitutes homologous series.
- ❖ The IUPAC name of the any organic compound consist of three parts. **ROOTWORD, PREFIX and / or SUFFIX.**

- ❖ Functional group may be defined as an atom or group of atom or reactive part which is responsible for the characteristic properties of the compounds
- ❖ Ethanoic acid is most commonly known as acetic acid and belongs to a group of acids called carboxylic acids.
- ❖ Ethanol or ethyl alcohol or simply alcohol is one of the most important members of the family of alcohols.
- ❖ The slow chemical change that takes place in complex organic compounds by the action of enzymes leading to the formation of simple molecules is called fermentation.
- ❖ Soaps are sodium or potassium salts of some long chain carboxylic acids.
- ❖ Detergents are sodium salts of sulphonic acids. Thus instead of  $\text{-COOH}$  group in soaps, detergents contain  $\text{-SO}_3\text{H}$  group



## TEXTBOOK EVALUATION



### I. Choose the best answer.

- The molecular formula of an open chain organic compound is  $C_3H_6$ . The class of the compound is
  - alkane
  - alkene
  - alkyne
  - alcohol
- The IUPAC name of an organic compound is 3-Methyl butan-1-ol. What type compound it is?
  - Aldehyde
  - Carboxylic acid
  - Ketone
  - Alcohol
- The secondary suffix used in IUPAC nomenclature of an aldehyde is \_\_\_\_
  - ol
  - oic acid
  - al
  - one
- Which of the following pairs can be the successive members of a homologous series?
  - $C_3H_8$  and  $C_4H_{10}$
  - $C_2H_2$  and  $C_2H_4$
  - $CH_4$  and  $C_3H_6$
  - $C_2H_5OH$  and  $C_4H_8OH$
- $C_2H_5OH + 3O_2 \rightarrow 2CO_2 + 3H_2O$  is a
  - Reduction of ethanol
  - Combustion of ethanol
  - Oxidation of ethanoic acid
  - Oxidation of ethanal
- Rectified spirit is an aqueous solution which contains about \_\_\_\_\_ of ethanol
  - 95.5 %
  - 75.5 %
  - 55.5 %
  - 45.5 %
- Which of the following are used as anaesthetics?
  - Carboxylic acids
  - Ethers
  - Esters
  - Aldehydes
- TFM in soaps represents \_\_\_\_\_ content in soap
  - mineral
  - vitamin
  - fatty acid
  - carbohydrate

- Which of the following statements is wrong about detergents?
  - It is a sodium salt of long chain fatty acids
  - It is sodium salts of sulphonic acids
  - The ionic part in a detergent is  $-SO_3^-Na^+$
  - It is effective even in hard water.

### II. Fill in the blanks

- An atom or a group of atoms which is responsible for chemical characteristics of an organic compound is called \_\_\_\_\_.
- The general molecular formula of alkynes is \_\_\_\_\_.
- In IUPAC name, the carbon skeleton of a compound is represented by \_\_\_\_\_ (root word / prefix / suffix)
- (Saturated / Unsaturated) \_\_\_\_\_ compounds decolourize bromine water.
- Dehydration of ethanol by conc. Sulphuric acid forms \_\_\_\_\_ (ethene/ ethane)
- 100 % pure ethanol is called \_\_\_\_\_
- Ethanoic acid turns \_\_\_\_\_ litmus to \_\_\_\_\_
- The alkaline hydrolysis of fatty acids is termed as \_\_\_\_\_
- Biodegradable detergents are made of \_\_\_\_\_ (branched / straight) chain hydrocarbons

### III. Match the following

Functional group -OH	-	Benzene
Heterocyclic	-	Potassium stearate
Unsaturated	-	Alcohol
Soap	-	Furan
Carbocyclic	-	Ethene

**IV. Assertion and Reason:**

Answer the following questions using the data given below:

- i) A and R are correct, R explains the A.
  - ii) A is correct, R is wrong.
  - iii) A is wrong, R is correct.
  - iv) A and R are correct, R doesn't explain A.
1. **Assertion:** Detergents are more effective cleansing agents than soaps in hard water.

**Reason:** Calcium and magnesium salts of detergents are water soluble.

2. **Assertion:** Alkanes are saturated hydrocarbons.

**Reason:** Hydrocarbons consist of covalent bonds.

**V. Short answer questions**

1. Name the simplest ketone and give its structural formula.
2. Classify the following compounds based on the pattern of carbon chain and give their structural formula: (i) Propane (ii) Benzene (iii) Cyclobutane (iv) Furan
3. How is ethanoic acid prepared from ethanol? Give the chemical equation.
4. How do detergents cause water pollution? Suggest remedial measures to prevent this pollution?
5. Differentiate soaps and detergents.

**VI. Long answer questions**

1. What is called homologous series? Give any three of its characteristics?
2. Arrive at, systematically, the IUPAC name of the compound:  $\text{CH}_3\text{-CH}_2\text{-CH}_2\text{-OH}$ .
3. How is ethanol manufactured from sugarcane?
4. Give the balanced chemical equation of the following reactions:
  - (i) Neutralization of NaOH with ethanoic acid.

- (ii) Evolution of carbon dioxide by the action of ethanoic acid with  $\text{NaHCO}_3$ .
  - (iii) Oxidation of ethanol by acidified potassium dichromate.
  - (iv) Combustion of ethanol.
5. Explain the mechanism of cleansing action of soap.

**VII. HOT questions**

1. The molecular formula of an alcohol is  $\text{C}_4\text{H}_{10}\text{O}$ . The locant number of its  $\text{-OH}$  group is 2.
  - (i) Draw its structural formula.
  - (ii) Give its IUPAC name.
  - (iii) Is it saturated or unsaturated?
2. An organic compound 'A' is widely used as a preservative and has the molecular formula  $\text{C}_2\text{H}_4\text{O}_2$ . This compound reacts with ethanol to form a sweet smelling compound 'B'.
  - (i) Identify the compound 'A'.
  - (ii) Write the chemical equation for its reaction with ethanol to form compound 'B'.
  - (iii) Name the process.

**REFERENCE BOOKS**

1. Organic chemistry - B.S.Bahl & Arun Bahl S.Chand publishers, New delhi.
2. Organic chemistry - R.T.Morrison & R.MN. Boyd - Prentice Hall Publishers. New Delhi

**INTERNET RESOURCES**

- <https://www.tutorvista.com/>  
<https://www.topperlearning.com/>  
<http://www.chem4kids.com/>

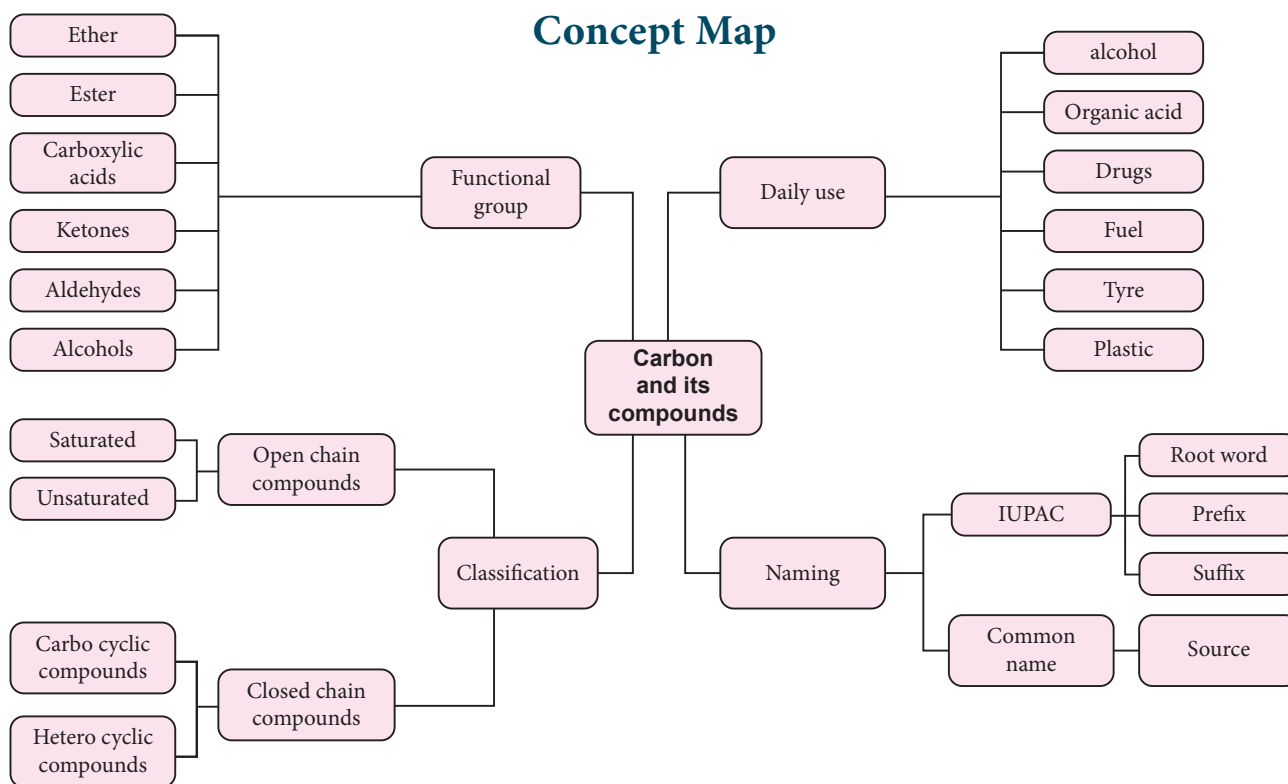

## ICT CORNER

## Organic Carbon and its Compounds

The students can know about the Hydrocarbons, its formulae, descriptions and also in animated form.



### Steps

- Type the URL or use the QR code to access the application “Organic chemistry visualized / OCV” and install in the mobile.
- Click ‘Content’ to view the list of Hydrocarbon. Explore about the hydrocarbons by clicking those.
- On clicking ‘anim’ button, you can view the formulae of hydrocarbon as well as in animated form.
- Click ‘Quiz’ to evaluate yourself in this topic.

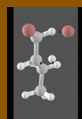

Step1

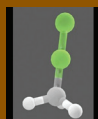

Step2

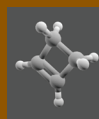

Step3

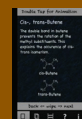

Step4

URL: <https://play.google.com/store/apps/details?id=com.budgietainment.oc>  
or Scan the QR Code.

\*Pictures are indicative only



B375\_10\_SCIENCE\_EM

 UNIT  
12

 PLANT ANATOMY  
AND PLANT PHYSIOLOGY

**Learning Objectives**

At the end of this lesson the students will be able to:

- ◆ Understand vascular tissue system- their types and functions.
- ◆ Know the structure of dicot root, stem, leaf and monocot root, stem, leaf.
- ◆ Differentiate the internal structure of dicot root, stem, leaf with that of monocot root, stem, leaf.
- ◆ Name the different pigments found in chloroplast.
- ◆ Elaborate on the structure and functions of plastids.
- ◆ Enumerate the steps involved in photosynthesis.
- ◆ Understand the structure of mitochondria
- ◆ List the basic events of aerobic and anerobic respiration.



J5J19X

**Introduction**

Plants exhibits varying degrees of organization. Atoms are organized into molecules, molecules into organelles, organelles into cells, cells into tissues and tissues into organs. The first account of internal structure of plants was published by English Physician **Nehemiah Grew**. He is known as **Father of Plant Anatomy**. Plant anatomy (Gk *Ana* = as under; *Temnein* = to cut) is the study of internal structure of plants. You have already studied the different kinds of tissues in standard IX. In this lesson, you will study about the internal structure of plant tissues, process of photosynthesis and respiration.

**12.1 Tissues**

Tissues are the group of cells that are similar or dissimilar in structure and origin, but perform similar function. Plant tissues

can be broadly classified into two, based on their ability to divide. They are

- i) Meristamatic tissue
- ii) Permanent tissue.

**12.2 Tissue system**

Sachs (1875) classified tissue system in plants into three types

- i) Dermal or Epidermal tissue system
- ii) Ground tissue system
- iii) Vascular tissue system

The functions of these tissues are given in Table 12.1.

**12.2.1 Dermal or Epidermal Tissue System**

It consists of epidermis, stomata and epidermal outgrowths. Epidermis is the outer most layer. It has many minute pores called stomata.

**Table 12.1** Tissue system and its functions

Tissue System	Components	Functions
Dermal Tissue System	Epidermis and Periderm (in older stems and roots)	<ul style="list-style-type: none"> <li>• Protection</li> <li>• Prevention of water loss</li> </ul>
Ground Tissue System	Parenchyma tissue Collenchyma tissue Sclerenchyma tissue	<ul style="list-style-type: none"> <li>• Photosynthesis</li> <li>• Food storage</li> <li>• Regeneration</li> <li>• Support</li> <li>• Protection</li> </ul>
Vascular Tissue System	Vascular tissues - Xylem tissue - Phloem tissue	<ul style="list-style-type: none"> <li>• Transport of water and minerals</li> <li>• Transport of food</li> </ul>

Cuticle is present on the outer wall of epidermis to check evaporation of water. Trichomes and root hairs are the epidermal outgrowths.

**Functions:**

- i) Epidermis protects the inner tissues.
- ii) Stomata helps in transpiration.
- iii) Root hairs help in absorption of water and minerals.

**12.2.2 Ground Tissue System**

It includes all the tissues of the plant body except epidermal and vascular tissues like (i) Cortex (ii) Endodermis (iii) Pericycle (iv) Pith

**12.2.3 Vascular Tissue System**

It consists of xylem and phloem tissues. They are present in the form of bundles called vascular bundles. Xylem conducts water and minerals to different parts of the plant. Phloem conducts food materials to different parts of the plant.

There are three different types of vascular bundles namely (i) Radial (ii) Conjoint (iii) Concentric

**(i) Radial Bundles**

Xylem and phloem are present in different radii alternating with each other. e.g. roots

**(ii) Conjoint bundles**

Xylem and phloem lie on the same radius. There are two types of conjoint bundles.

**a) Collateral**

Xylem lies towards the centre and phloem lies towards the periphery.

When cambium is present in collateral bundles, it is called open. e.g. dicot stem and collateral bundle without cambium is called closed. e.g. monocot stem.

**b) Bicollateral**

In this type of bundle, the phloem is present on both outer and inner side of xylem. e.g. *Cucurbita*

**(iii) Concentric Bundles**

Vascular bundle in which xylem completely surrounds the phloem or viceversa is called concentric vascular bundle. It is of two types:

1. **Amphivasal:** Xylem surrounds phloem. e.g. *Dracaena*
2. **Amphicribal:** Phloem surrounds xylem. e.g. Ferns

**Endarch:** Protoxylem lies towards the centre and metaxylem lies towards the periphery. e.g. stem.

**Exarch :** Protoxylem lies towards the periphery and metaxylem lies towards the centre. e.g. roots.

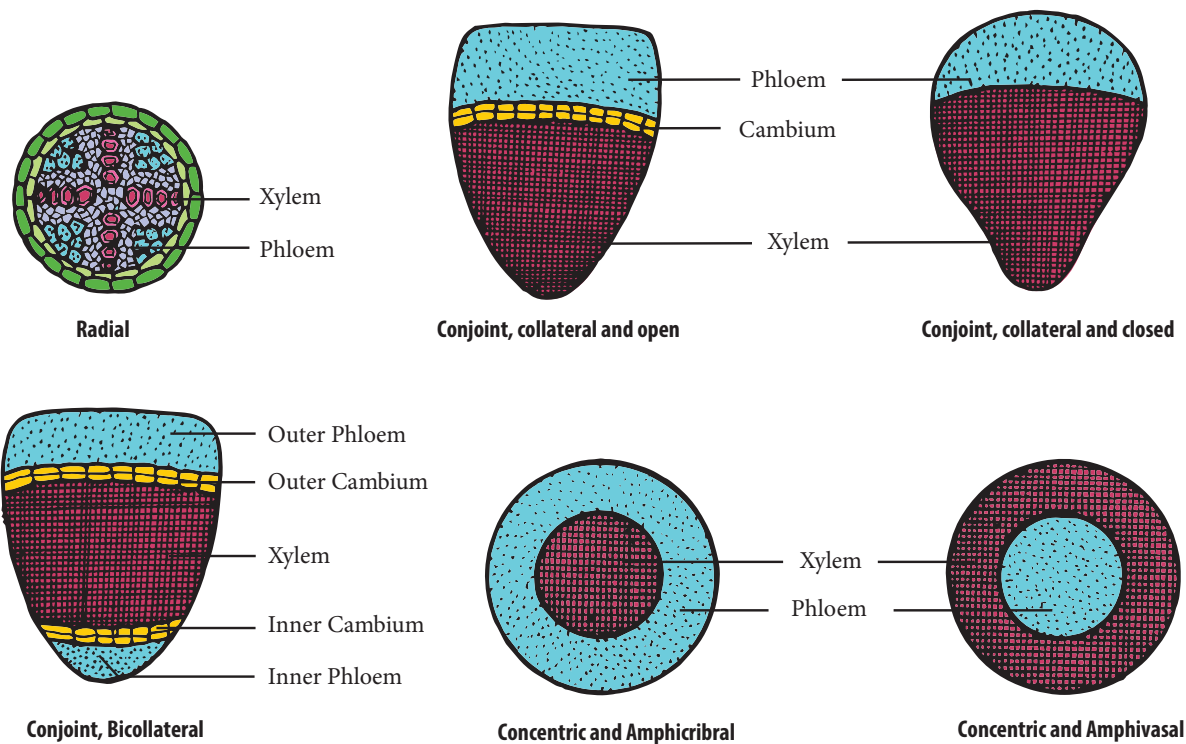

Figure 12.1 Types of vascular bundle

### 12.3 Internal Structure of Dicot Root (Bean)

A thin transverse section of dicot root shows the following structures.

(i) **Epiblema:** It is the outermost layer. Cuticle and stomata are absent. Unicellular root hairs are present. It is also known as **Rhizodermis** or **Piliferous layer**.

(ii) **Cortex:** It is a multilayered large zone made of thin-walled parenchymatous cells with intercellular spaces. It stores food and water.

(iii) **Endodermis:** It is the innermost layer of cortex. The cells are barrel-shaped, closely packed, and show band like thickenings on their radial and inner tangential walls called **casparian strips**. But these casparian strips are absent in the endodermis cells which are located opposite the protoxylem these thin walled cells without casparian strips are called passage cell. It helps in the movement of water and dissolved salts from cortex into xylem.

(iv) **Stele:** All tissues inner to endodermis constitute stele. It includes pericycle and vascular bundle.

(a) **Pericycle:** Inner to endodermis lies a single layer of pericycle. It is the site of origin of lateral roots.

(b) **Vascular bundle:** It is radial. Xylem is **exarch** and **tetrach**. The tissue present between xylem and phloem is called conjunctive tissue. In dicot root, it is made up of parenchyma.

(c) **Pith:** Young root contains pith whereas in old root pith is absent.

### 12.4 Internal Structure of Monocot Root (Maize)

A thin transverse section of monocot root, shows the following characteristic features.

i. **Epiblema or Rhizodermis:** It is the outermost layer of the root, and is made up of single layer of thin walled, parenchymatous cell. Stomata and cuticle are absent. The root hair helps in absorption of water and minerals from the soil. This layer also protects the inner tissues.

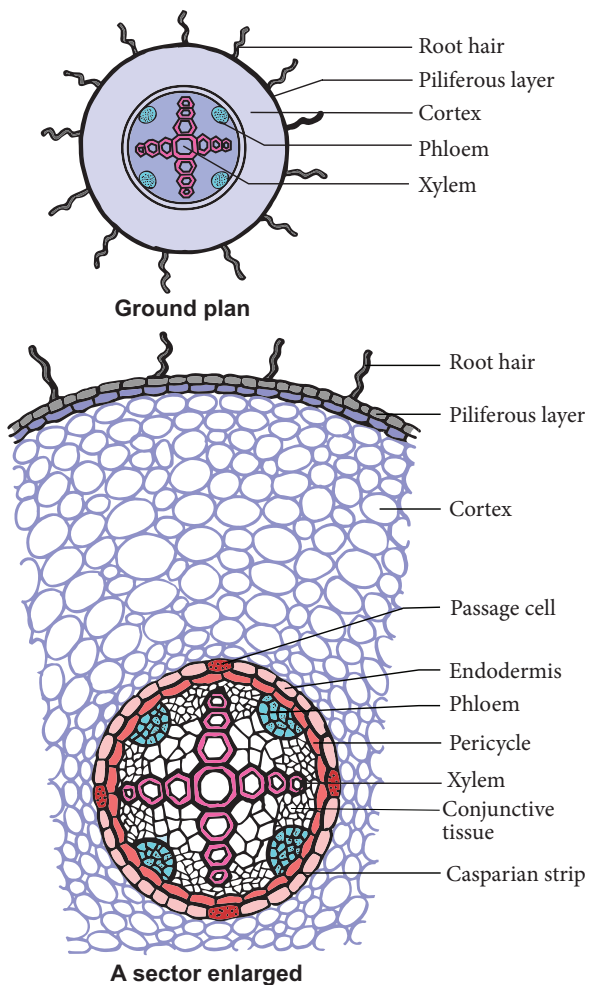

Figure 12.2 Transverse section of Dicot root

ii. **Cortex:** It is multilayered large zone, composed of parenchymatous cells with intercellular spaces. It stores water and food material.

iii. **Endodermis:** It is the innermost layer of cortex with characteristic casparian strips and passage cells. **Casparian strips** are band like thickening made of **suberin**.

iv. **Stele:** All the tissues inner to endodermis constitute stele. It includes pericycle, vascular tissues and pith.

a) **Pericycle:** It is a single layer of thin walled cells. The lateral roots originate from this layer.

b) **Vascular tissues:** It consists of many patches of xylem and phloem arranged radially. The xylem is exarch and polyarch. The conjunctive tissue is made up of sclerenchyma.

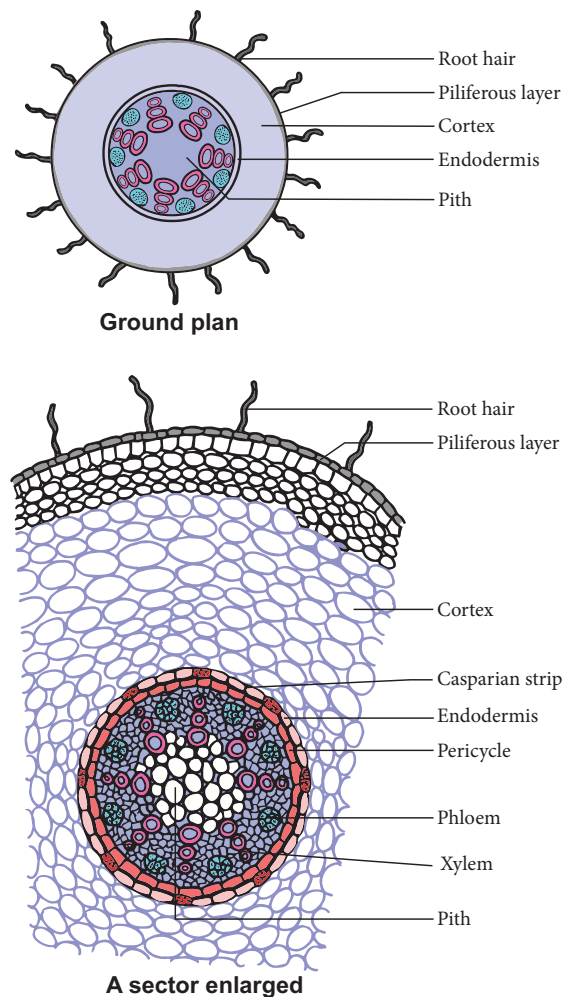

Figure 12.3 Transverse section of Monocot root

c) **Pith:** It is present at the center. It is made up of parenchyma cells with intercellular spaces. It contains abundant amount of starch grains. It stores food.

### 12.5 Internal Structure of Dicot Stem (Sunflower)

The transverse section of a dicot stem reveals the following structures.

1. **Epidermis:** It is the outermost layer. It is made up of single layer of parenchyma cells, its outer wall is covered with cuticle. It is protective in function.

2. **Cortex:-** It is divided into three regions:

(i) **Hypodermis:** It consists of 3 - 6 layers of collenchyma cells. It gives mechanical support.



Table 12.2 Differences between Dicot and Monocot root

S. No.	Tissues	Dicot Root	Monocot Root
1	Number of Xylem	Tetrarch	Polyarch
2	Cambium	Present (During secondary growth only)	Absent
3	Secondary Growth	Present	Absent
4	Pith	Absent	Present
5	Conjunctive Tissue Ex.	Parenchyma Bean	Sclerenchyma Maize

(ii) **Middle cortex:** It is made up of few layers of chlorenchyma cells. It is involed in photosynthesis due to the presence of chloroplast.

(iii) **Inner cortex:** It is made up of few layers of parenchyma cells. It helps in gaseous exchange and stores food materials.

**Endodermis** is the inner most layer of cortex it consists of a single layer of barrel shaped cells, these cells contain starch grains. So it is also called **starch sheath**.

3. **Stele:** The central part of the stem inner to endodermis is known as stele. It consists of pericycle, vascular bundle and pith.

(i) **Pericycle:** It occurs between vascular bundle and endodermis. It is multilayered, parenchymatous with alternating patches of sclerenchyma.

(ii) **Bundle Cap:** There is a patch of hard sclerenchyma tissue outside to the phloem of vascular bundle is calld Bundle Cap.

(iii) **Vascular bundle:** Vascular bundles are conjoint, collateral, endarch and open. They are arranged in the form of a ring around the pith.

(iv) **Pith:** The large central parenchymatous zone with intercellular spaces is called pith. It helps in the storage of food materials.

cells. It is covered with thick cuticle. Multicellular hairs are absent and stomata are also less in number.

2. **Hypodermis:** It is made up of few layers of sclerenchyma cells interrupted by chlorenchyma. Sclerenchyma provides mechanical support to plant.

3. **Ground tissue:** The entire mass of parenchyma cells next to hypodermis

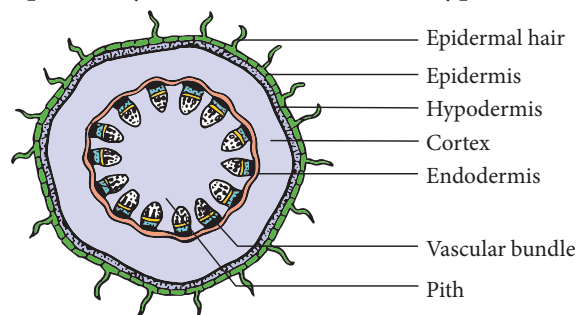

Ground plan

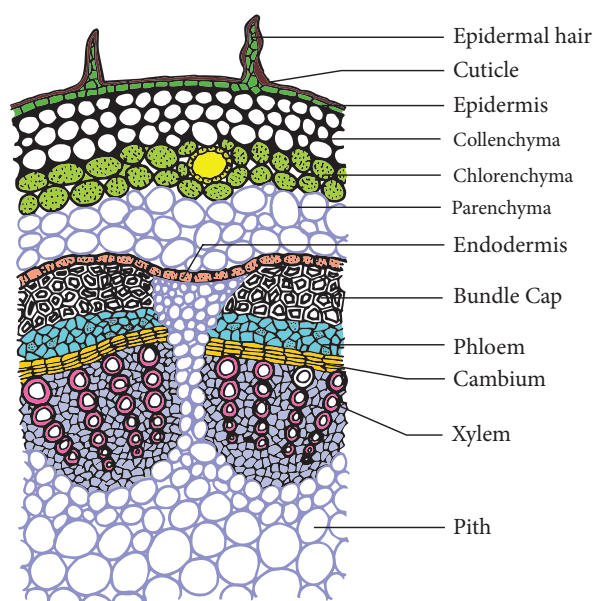

A sector enlarged

Figure 12.4 Transverse section of Dicot stem

### 12.6 Internal Structure of Monocot Stem (Maize)

A transverse section of monocot stem reveals the following structures.

1. **Epidermis:** It is the outermost layer. It is made up of single layer of parenchyma

and extending to the centre is called **ground tissue**. It is not differentiated into endodermis, cortex, pericycle and pith.

4. **Vascular Bundle:** Vascular bundles are skull shaped and scattered in the ground tissue. Vascular bundles are conjoint, collateral, endarch and closed. Each vascular bundle is surrounded by few layer of sclerenchyma cells called **bundle sheath**.

(a) **Xylem:** It consists of metaxylem and protoxylem. Xylem vessels are arranged in V or Y shape. In mature vascular bundle, the lower most protoxylem disintegrates and form a cavity. This is called **protoxylem lacuna**.

(b) **Phloem:** It consists of sieve tube elements and companion cells. Phloem parenchyma, and phloem fibers are absent.

5. **Pith:** Pith is not differentiated in monocot stems.

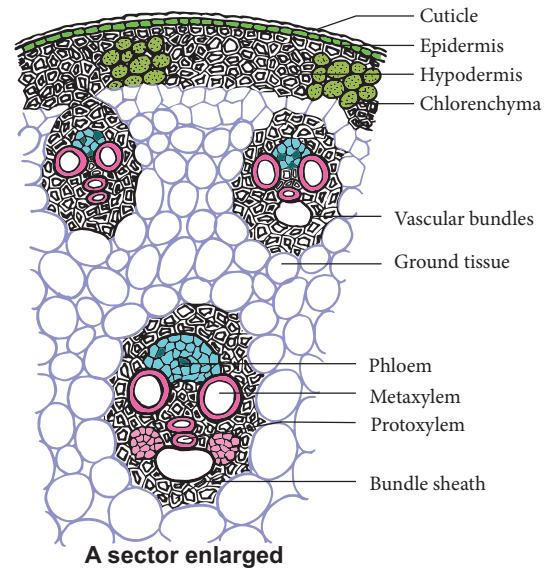
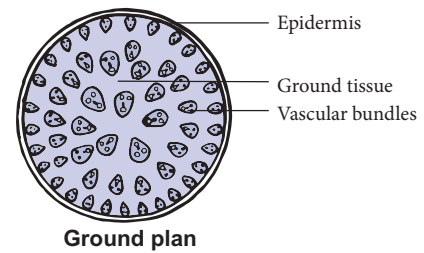

**Figure 12.5** Transverse section of Monocot stem

**Table 12.3** Differences between Dicot Stem Ex.Sunflower and Monocot Stem Ex.Maize

S. No.	Tissues	Dicot Stem	Monocot Stem
1	Hypodermis	Collenchymatous	Sclerenchymatous
2	Ground tissue	Differentiated into cortex, endodermis, pericycle and pith	Undifferentiated
3	Vascular bundles	(i) Less in number (ii) Uniform in size (iii) Arranged in a ring (iv) Open (Cambium present) (v) Bundle sheath absent	(i) Numerous (ii) Smaller near periphery, bigger in the centre (iii) Scattered (iv) Closed (Cambium absent) (v) Bundle sheath present
4	Secondary growth	Present	Mostly absent
5	Pith	Present	Absent
6	Medullary rays	Present	Absent

### 12.7 Internal Structure of Dicot Leaf (Dorsiventral Leaf) Ex. Mango Leaf

The transverse section of leaf shows the following structures.

(i) **Upper epidermis:** This is the outermost layer made of single layered parenchymatous cells without intercellular spaces. The outer wall of the cells are cuticularized. Stomata are less in number.

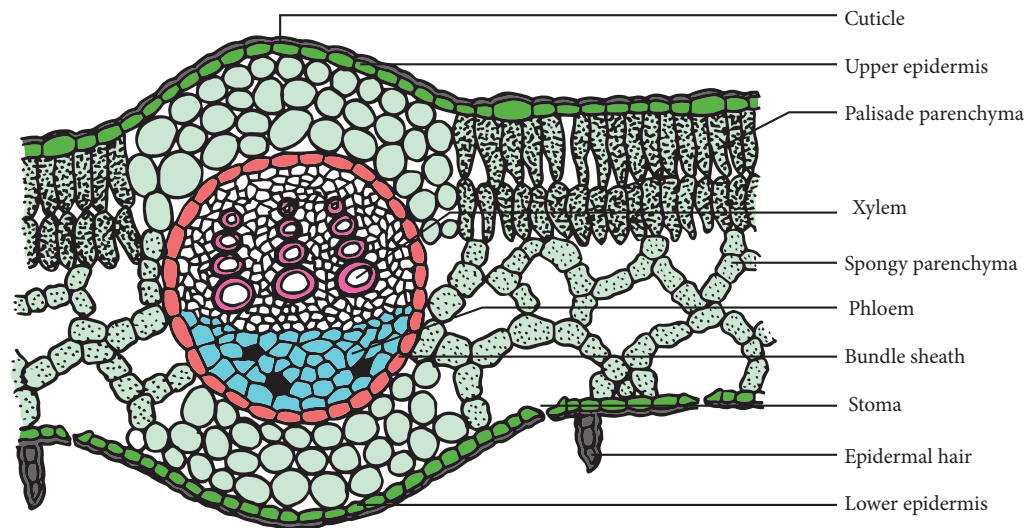

Figure 12.6 Transverse section of Dicot leaf

(ii) **Lower epidermis:** It is a single layer of parenchymatous cells with a thin cuticle. It contains numerous stomata. Chloroplasts are present only in guard cells. The lower epidermis helps in the exchange of gases. The loss of water vapour is facilitated through this chamber.

(iii) **Mesophyll:** The tissue present between the upper and lower epidermis is called mesophyll. It is differentiated into Palisade parenchyma and Spongy parenchyma.

a) **Palisade parenchyma:** It is found just below the upper epidermis. The cells are elongated. These cells have more number of chloroplasts. The cells do not have intercellular spaces and they take part in photosynthesis.

b) **Spongy parenchyma:** It is found below the palisade parenchyma tissue. Cells are almost spherical or oval and are irregularly arranged. Cells have intercellular spaces. It helps in gaseous exchange.

(iv) **Vascular bundles:** Vascular bundle are present in mid-rib and lateral veins. Vascular bundles are conjoint, collateral and closed. Each vascular bundle is surrounded by a sheath of

parenchymatous cells called **bundle sheath**. Each vascular bundle consists of xylem lying towards the upper epidermis and phloem towards the lower epidermis.

### 12.8 Internal Structure of Monocot Leaf (Isobilateral Leaf) Ex. Grass Leaf

The transverse section of a monocot leaf reveals the following structures.

(i) **Epidermis:** Monocot leaf has upper and lower epidermis. Epidermis is made up of parenchyma cells. Cuticle is present on the outer wall stomata are present on both upper and lower epidermis. Some cells of upper epidermis are large and thin walled they are known as **bulliform cells**.

(ii) **Mesophyll:** It is the ground tissue that is present between both epidermal layers. Mesophyll is not differentiated into palisade and spongy parenchyma. The cells are irregularly arranged with inter-cellular spaces. These cells contain chloroplasts.

(iii) **Vascular bundles:** Large number of vascular bundles are present, some of which are small and some are large.

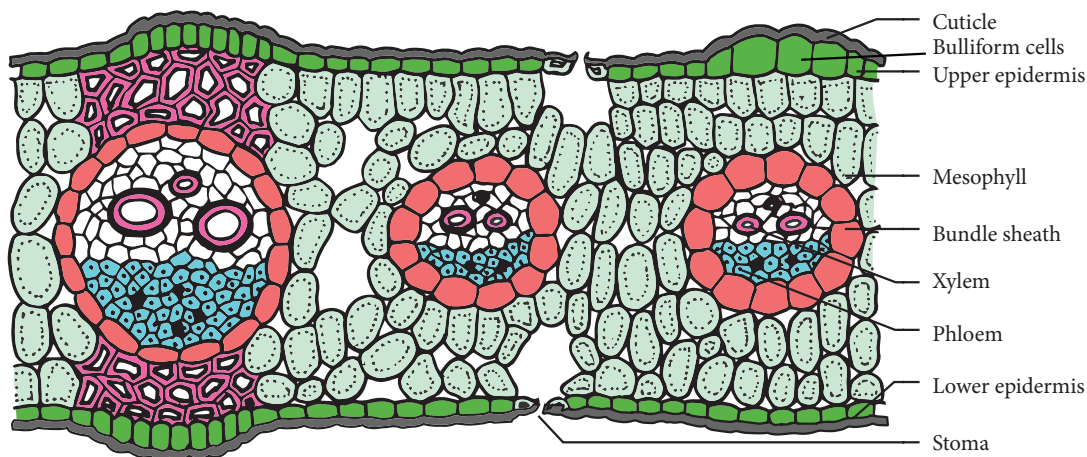

Figure 12.7 Transverse section of Monocot Leaf

Each vascular bundle is surrounded by parenchymatous bundle sheath. Vascular bundles are conjoint, collateral and closed. Xylem is present towards upper epidermis and phloem towards lower epidermis.

Table 12.4 Differences between of Dicot and Monocot Leaf

S. No.	Dicot Leaf	Monocot Leaf
1	Dorsiventral leaf	Isobilateral leaf
2	Mesophyll is differentiated into palisade and spongy parenchyma	Mesophyll is not differentiated into palisade and spongy parenchyma

## 12.9 Plant Physiology

### 12.9.1 Plastids

Plastids are double membrane bound organelles found in plants and some algae. They are responsible for preparation and storage of food. There are three types of plastids.

- Chloroplast - green coloured plastids
- Chromoplast - yellow, red, orange coloured plastids
- Leucoplast - colourless plastids

### 12.9.2 Structure of Chloroplast

Chloroplasts are green plastids containing green pigment called **chlorophyll**. Chloroplasts are oval shaped organelles having a diameter of 2-10 micrometer and a thickness of 1-2 micrometer.

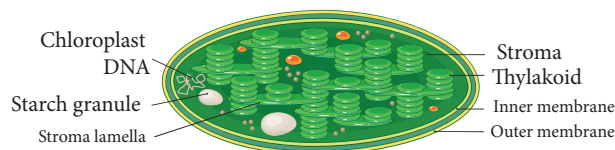

Figure 12.8 Ultrastructure of Chloroplast

1. **Envelope:** Chloroplast envelope has outer and inner membranes which is separated by intermembrane space.
2. **Stroma:** Matrix present inside to the membrane is called stroma. It contains DNA, 70 S ribosomes and other molecules required for protein synthesis.
3. **Thylakoids:** It consists of thylakoid membrane that encloses thylakoid lumen. Photosynthetic pigments are present in thylakoids. Thylakoids forms a stack of **disc like structures** called a grana (singular-granum).
4. **Grana:** Thylakoids arranged in the form of discs stacked one above the other called granum. Grana are inter connected by stroma lamella.

### 12.9.3 Functions of Chloroplast

1. Photosynthesis
2. Storage of starch
3. Synthesis of fatty acids
4. Storage of lipids
5. Formation of chloroplasts

### 12.9.4 Photosynthesis

Photosynthesis (Photo = light; synthesis = to build) is a process by which autotrophic organisms like green plants, algae and chlorophyll containing bacteria utilize the energy from sunlight to synthesize their own food. In this process, carbon dioxide combines with water in the presence of sunlight and chlorophyll to form carbohydrates. During this process oxygen is released as a byproduct.

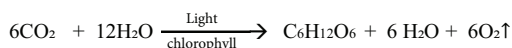

Carbon dioxide + Water  $\longrightarrow$  Glucose + Water + Oxygen

### 12.9.5 Where does photosynthesis occur?

Photosynthesis occurs in all green parts of the plant especially in green leaves.

### 12.9.6 Photosynthetic Pigments

Pigments involved in photosynthesis are called **Photosynthetic pigments**. Photosynthetic pigments are of two classes namely, the primary pigments and accessory pigments. Chlorophyll a is the **primary pigment** that traps solar energy and converts it into electrical and chemical energy. Thus it is called the reaction centre. Other pigments such as chlorophyll b and carotenoids are called **accessory pigments** as they pass on the absorbed energy to chlorophyll a (Chl.a) molecule. Reaction centre (Primary pigments) and harvesting centre (Accessory pigments) together form Pigment systems.

### 12.9.7 Role of Sunlight in Photosynthesis

The entire process of photosynthesis takes place inside the chloroplast. The structure of chloroplast is such that the light dependent (**Light reaction**) and light independent (**Dark reaction**) take place at different sites in the organelle

#### 1. Light dependent Reaction (Hill reaction \ Light reaction)

This was discovered by **Robin Hill** (1939). This reaction takes place in the presence of light energy in **thylakoid membranes** (grana) of the chloroplasts. Photosynthetic pigments absorb the light energy and convert it into chemical energy ATP and NADPH<sub>2</sub>. These products of light reaction move out from the thylakoid to the stroma of the chloroplast.

#### More to Know

ATP	Adenosine Triphosphate
ADP	Adenosine Diphosphate
NAD	Nicotinamide Adenine Dinucleotide
NADP	Nicotinamide Adenine Dinucleotide Phosphate



A cell cannot get its energy directly from glucose. So in respiration the energy released from glucose is used to make ATP (Adenosine Triphosphate)

#### 2. Light independent reactions (Dark reaction) (Biosynthetic phase)

Dark reaction or biosynthetic pathway is takes place in **stroma**. During this reaction CO<sub>2</sub> is reduced into carbohydrates with the help of light generated **ATP** and **NADPH<sub>2</sub>**. This is also called as **Calvin cycle** and is carried out in the absence of light. It is called dark reaction.

In Calvin cycle the inputs are CO<sub>2</sub> from the atmosphere and the ATP and NADPH<sub>2</sub> produced from light reaction.

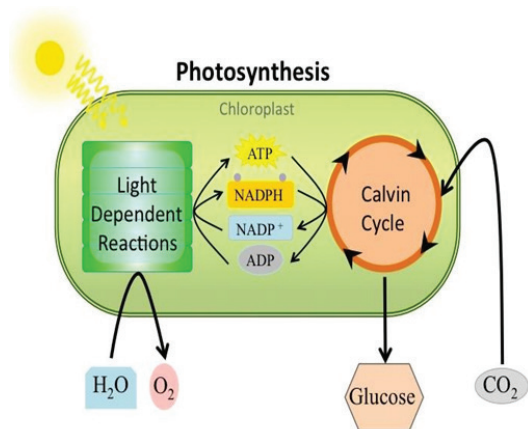



Figure 12.9 Overview of Hill and Calvin cycle



Melvin Calvin, an American biochemist, discovered chemical pathway for photosynthesis. The cycle is named as Calvin cycle. He was awarded with Nobel Prize in the year 1961 for his discovery.

### 12.9.8 Factors Affecting Photosynthesis

- a) **Internal Factors:**
  - i) Pigments ii) Leaf age iii) Accumulation of carbohydrates iv) Hormones
- b) **External Factors:**
  - i) Light ii) Carbon dioxide iii) Temperature iv) Water v) Mineral elements

#### Info bit

Artificial photosynthesis is a method for producing renewable energy by the use of sunlight. Indian scientist C.N.R. Rao who was conferred the Bharat Ratna (2013) is also working on similar technology of artificial photosynthesis to produce - Hydrogen fuel (renewable energy).



## 12.10 Mitochondria

Mitochondria are filamentous or granular cytoplasmic organelles present in cells. The mitochondria were first discovered by Kolliker in 1857 as granular structures in striated muscles. Mitochondria (singular: mitochondrion) are organelles within eukaryotic cells that produce adenosine triphosphate (ATP) which form the energy currency of the cell, for this reason, the mitochondria is referred to as the “**Power house of the cell**”. Mitochondria vary in size from 0.5 μm to 2.0 μm. Mitochondria contain 60-70% protein, 25-30% lipids, 5-7% RNA and small amount of DNA and minerals.

### 12.10.1 Structure of Mitochondria

**Mitochondrial Membranes:** It consists two membranes called inner and outer membrane. Each membrane is 60-70 Å thick. Outer mitochondrial membrane is smooth and freely permeable to most small molecules. It contains enzymes, proteins and lipids. It has **porin molecules** (proteins) which form channels for passage of molecules through it.

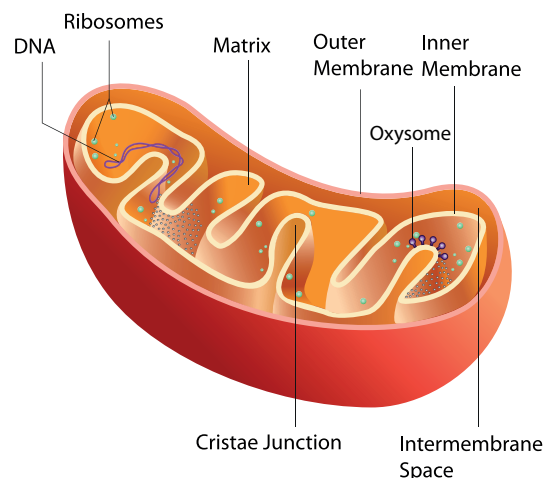

Figure 12.10 Structure of Mitochondria

Inner mitochondrial membrane is semi permeable membrane and regulates the passage of materials into and out of the mitochondria. It is rich in enzymes and carrier proteins. It consists of 80% proteins and lipids.

**Cristae:** The inner mitochondrial membrane gives rise to finger like projections called cristae. These cristae increase the inner surface area (fold in inner membrane) of the mitochondria to hold variety of enzymes.

**Oxysomes:** The inner mitochondrial membrane bear minute regularly spaced tennis racket shaped particles known as oxysomes ( $F_1$  particle). They involve in ATP synthesis.

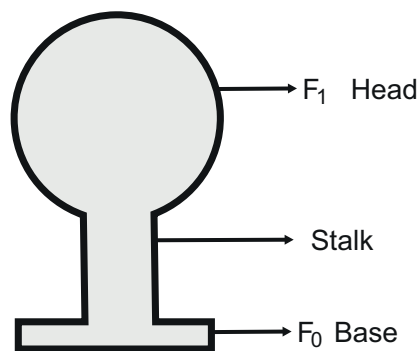

Figure 12.11 Structure of Oxysomes

**Mitochondrial matrix** - It is a complex mixture of proteins and lipids. Matrix contains enzymes for Krebs cycle, mitochondrial ribosomes(70 S), tRNAs and mitochondrial DNA.

### 12.10.2 Functions of Mitochondria

- Mitochondria is the main organelle of cell respiration. They produce a large number of ATP molecules. So they are called as **power houses of the cell** or **ATP factory of the cell**.
- It helps the cells to maintain normal concentration of calcium ions.
- It regulates the metabolic activity of the cell.

## 12.11 TYPES OF RESPIRATION

Respiration involves exchange of gases between the organism and the external environment. The plants obtain oxygen from

their environment and release carbon dioxide and water vapour. This exchange of gases is known as **external respiration**. It is a physical process. Biochemical process occurs within cells where the food is oxidized to obtain energy, this is known as cellular respiration

### 12.11.1 Aerobic respiration

Aerobic respiration is the type of cellular respiration in which organic food is completely oxidized with the help of oxygen into carbon dioxide, water and energy. It occurs in most plants and animals.



#### Stages of Aerobic respiration

**a. Glycolysis** (Glucose splitting): It is the breakdown of one molecule of glucose (6 carbon) into two molecules of pyruvic acid (3 carbon). Glycolysis takes place in cytoplasm of the cell. It is the first step of both aerobic and anerobic respiration.

**b. Krebs Cycle:** This cycle occurs in mitochondria matrix. At the end of glycolysis, 2 molecules of pyruvic acid enter into mitochondria. The oxidation of pyruvic acid into  $CO_2$  and water takes place through this cycle. It is also called **Tricarboxylic Acid Cycle** (TCA).

**c. Electron Transport Chain:** This is accomplished through a system of electron carrier complex called **electron transport chain** (ETC) located on the inner membrane of the mitochondria.  $NADH_2$  and  $FADH_2$  molecules formed during glycolysis and Krebs cycle are oxidised to  $NAD^+$  and  $FAD^+$  to release the energy via electrons. The electrons, as they move through the system, release energy which is trapped by ADP to synthesize ATP. This is called **oxidative phosphorylation**. In this

process, O<sub>2</sub> the ultimate acceptor of electrons gets reduced to water.

### 12.11.2 Anaerobic respiration

Anaerobic respiration takes place without oxygen. Glucose is converted into ethanol (Ethanol fermentation by yeast) or lactic acid (lactic acid fermentation by bacteria).



### 12.11.3 Respiratory quotient (R.Q)

Respiratory quotient is the ratio of volume of carbon dioxide liberated and the volume of oxygen consumed during respiration. It is expressed as

$$RQ = \frac{\text{Volume of CO}_2 \text{ liberated}}{\text{Volume of O}_2 \text{ consumed}}$$

### Points to Remember

- ◆ Tissue is a group of similar or dissimilar cells, having a common origin and performing similar functions.
- ◆ Plants are capable of synthesizing glucose from CO<sub>2</sub> and H<sub>2</sub>O in the presence of light, by the process of photosynthesis.
- ◆ Light reaction takes place in grana of chloroplast.
- ◆ Dark reaction takes place in stroma of chloroplast.
- ◆ Respiration involves both external and cellular respiration.
- ◆ Aerobic respiration takes place in the presence of oxygen.
- ◆ Aerobic respiration occurs in three major steps like Glycolysis, Krebs cycle and Electron transport chain.



## TEXTBOOK EVALUATION



### I. Choose the correct answer

1. Casparian strips are present in the \_\_\_\_\_ of the root.
  - a) cortex
  - b) pith
  - c) pericycle
  - d) endodermis
2. The endarch condition is the characteristic feature of
  - a) root
  - b) stem
  - c) leaves
  - d) flower
3. The xylem and phloem arranged side by side on same radius is called \_\_\_\_\_.
  - a) radial
  - b) amphivasal
  - c) conjoint
  - d) None of these
4. Which is formed during anaerobic respiration
  - a) Carbohydrate
  - b) Ethyl alcohol
  - b) Acetyl CoA
  - d) Pyruvate

5. Kreb's cycle takes place in
  - a) chloroplast
  - b) mitochondrial matrix
  - c) stomata
  - d) inner mitochondrial membrane
6. Oxygen is produced at what point during photosynthesis?
  - a) when ATP is converted to ADP
  - b) when CO<sub>2</sub> is fixed
  - c) when H<sub>2</sub>O is splitted
  - d) All of these

### II. Fill in the blanks.

1. The innermost layer of cortex in root is called \_\_\_\_\_.
2. Xylem and phloem are arranged in an alternate radii constitute a vascular bundle called \_\_\_\_\_.



- Glycolysis takes place in \_\_\_\_\_.
- The source of O<sub>2</sub> liberated in photosynthesis is \_\_\_\_\_.
- \_\_\_\_\_ is ATP factory of the cells

**III. State whether the statements are true or false. Correct the false statement.**

- Phloem tissue is involved in the transport of water in plant.
- The waxy protective covering of a plant is called as cuticle.
- In monocot stem cambium is present in between xylem and phloem.
- Palisade parenchyma cells occur below upper epidermis in dicot root.
- Mesophyll contains chlorophyll.
- Anaerobic respiration produces more ATP than aerobic respiration.

**IV. Match the following**

- Amphicribal - *Dracaena*
- Cambium - Translocation of food
- Amphivasal - Fern
- Xylem - Secondary growth
- Phloem - Conduction of water

**V. Answer in a sentence**

- What is collateral vascular bundle?
- Where does the carbon that is used in photosynthesis come from?
- What is the common step in aerobic and anaerobic pathway?
- Name the phenomenon by which carbohydrates are oxidized to release ethyl alcohol.

**VI. Short answer questions**

- Give an account on vascular bundle of dicot stem.
- Write a short note on mesophyll.
- Draw and label the structure of oxysomes.
- Name the three basic tissues system in flowering plants.
- What is photosynthesis and where in a cell does it occur?

- What is respiratory quotient?
- Why should the light dependent reaction occur before the light independent reaction?
- Write the reaction for photosynthesis?

**VII. Long answer questions**

- Differentiate the following
  - Monocot root and Dicot root
  - Aerobic and Anaerobic respiration
- Describe and name three stages of cellular respiration that aerobic organisms use to obtain energy from glucose.
- How does the light dependent reaction differ from the light independent reaction? What are the end product and reactants in each? Where does each reaction occur within the chloroplast?

**VIII. Higher Order Thinking Skills(HOTS)**

- The reactions of photosynthesis make up a biochemical pathway.
  - What are the end product of light and dark reaction of photosynthesis?
  - Explain how the biochemical pathway of photosynthesis recycles many of its own reactions and identify the recycled reactants.
- Where do the light dependent reaction and the Calvin cycle occur in the chloroplast?



**REFERENCE BOOKS**

- Bajracharya D, Experiments in Plant Physiology, Narosa Publishing House, New Delhi
- Pandey B.P. Plant Anatomy, S.Chand and Company Ltd, New Delhi
- Verma P.S. and Agarwal V.K. Cytology, S.Chand and Company Ltd, New Delhi



**INTERNET RESOURCES**

- www.science daily.com  
www.britannica.com

## Concept Map

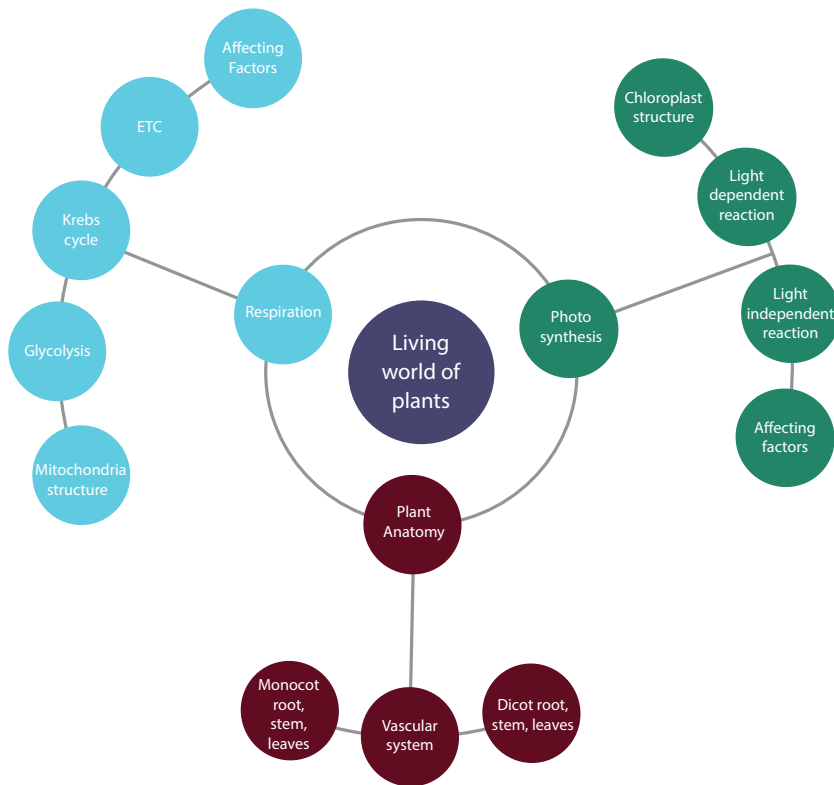

### ICT CORNER

### PLANT ANATOMY

**PHOTOSYNTHESIS** – This application enables students to play a game to adjust sunlight rays to reach the plant.

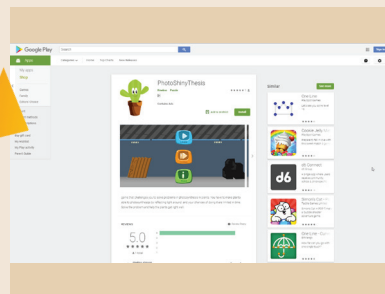

#### Steps

- Access the application Photosynthesis with the help of the provided URL or QR code. Install in your device. After opening the app, Click LEVELS to begin the game.
- A plant sapling will be in one side, and sun rays will be at the other side. You have to drag and adjust the mirror so that the sunlight rays will fall on the plant.
- At the top left, there is an indicator to show the timings.
- Explore and complete the other levels gradually.



Step1

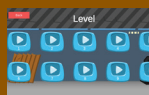

Step2



Step3



Step4

#### Cells alive

URL : <https://play.google.com/store/apps/details?id=com.Rinekso.PhotoSHinythesis>

\*Pictures are indicative only



B375\_10\_SCIENCE\_EM

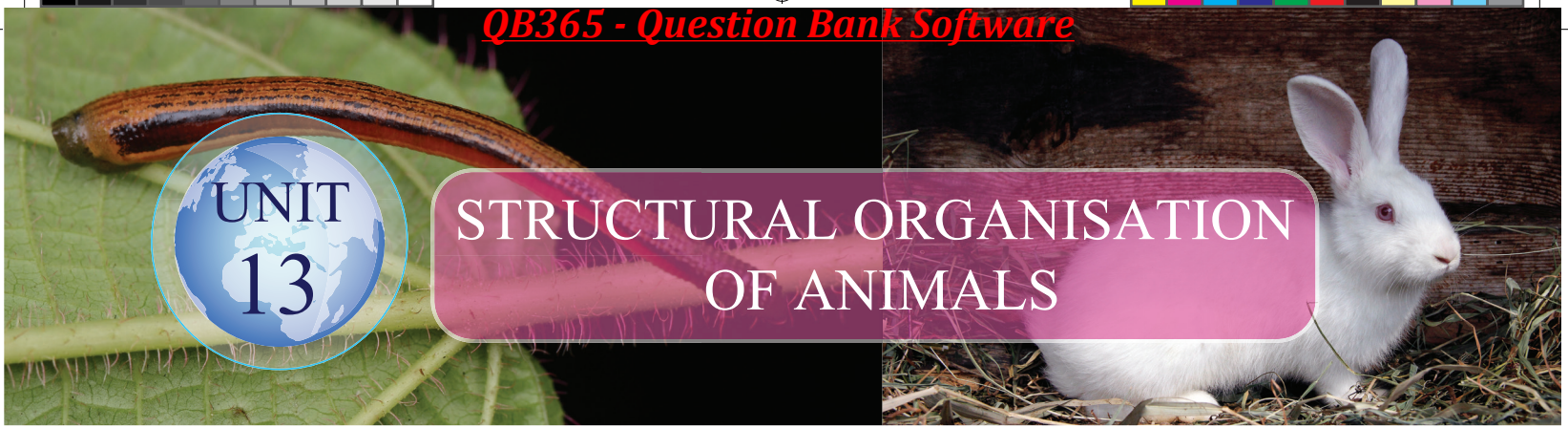

## Learning Objectives



At the end of this lesson the students will be able to:

- ◆ Understand the external morphology of the leech and rabbit.
- ◆ Recognise the structural features of different organ systems.
- ◆ Will be able to understand the physiology of various organ systems of leech and rabbit.
- ◆ Learn the parasitic adaptations of leech.
- ◆ Identify the type of dentition and its significance in rabbit.
- ◆ Perceive the differences between the structural organisation of an invertebrate (leech) and vertebrate (rabbit).

## Introduction

The variety in nature and habits of animals in the biosphere are quite amazing and interesting. What we see around us may be just few, but there are innumerable species living in this world. You have learnt in lower classes about the classification of animal kingdom. We will recall here that '**Kingdom Animalia**' is divided into two groups, **Invertebrates** and **Chordates**.

There occurs a great diversity in the habit, habitat, structural organisation and mode of reproduction between the animals existing on earth. In this chapter, you will understand the structural morphology and anatomy of an Invertebrate (Leech) and a Vertebrate (Rabbit).

The scientific name of the Indian cattle leech is *Hirudinaria granulosa* which belongs to **Phylum Annelida**. Annelids are **metamerically segmented worms** with well developed organ systems.

The scientific name of the common rabbit is *Oryctolagus cuniculus*. It represents **Phylum Chordata** and **Class Mammalia**. Mammals occupy the highest group in the animal kingdom and show advancement over the other groups of animals. They are warm blooded and possess covering of hair on the body. Mammary gland in females is the most striking feature of a mammal. Let us now study about the morphology of leech and rabbit in detail.

### 13.1 The Indian Cattle Leech (*Hirudinaria granulosa*)

Taxonomic Position	
Phylum	Annelida
Class	Hirudinea
Order	Gnathobdellida
Genus	<i>Hirudinaria</i>
Species	<i>granulosa</i>

#### 13.1.1 Habit and Habitat

*Hirudinaria granulosa* (Indian Cattle Leech) is found in India, Bangladesh, Pakistan, Myanmar and Srilanka. It lives in freshwater ponds, lakes, swamps and slow streams. They are **ectoparasitic** and feed on the blood of fishes, frogs, cattle and human. It is **sanguivorous** (blood sucking) in nature.

#### 13.1.2 External Morphology

**Shape and Size:** The body of a leech is soft, vermiform, elongated and segmented. It becomes ribbon shaped when extended and almost cylindrical when contracted. Leeches may grow to a length of 35cm.

**Colouration:** Dorsal surface is olive green in colour and the ventral surface is orange yellow or orange red in colour.

**Segmentation: Metamerism** is the segmentation of the body. The body of leech is metamericly divided into 33 **segments**. The segments are arranged one behind the other. Each segment is further superficially subdivided into *rings* or *annuli*. A temporary **clitellum** is formed on segments 9-11, which is meant to produce a **cocoon** during the breeding season.

**Receptors:** On the dorsal side there are five pairs of eyes on the first five segments. Each segment bears a number of sensory projections called receptors. **Annular receptors** are located in each annulus and **segmental receptors** are located on the first annulus of each segment.

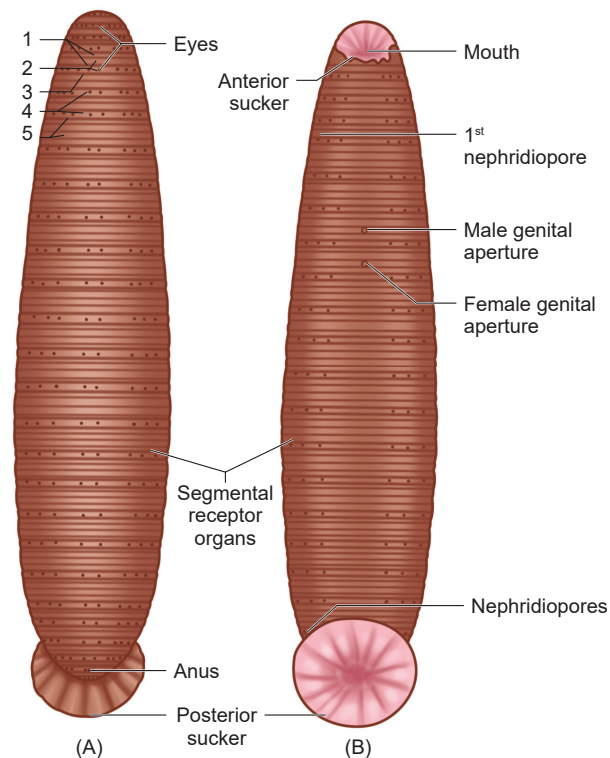

Figure 13.1 External morphology of Leech

A. Dorsal View

B. Ventral view

**Suckers:** Leech has two suckers. The sucker located at the anterior end is called **anterior sucker** or **oral sucker** which is ventral in position occupying the first five segments. The **posterior sucker** is formed by the fusion of the last seven segments. The anterior sucker helps in feeding, while both the suckers help in attachment and locomotion.

#### External apertures

- (i) **Mouth:** It is located in the middle of anterior sucker.
- (ii) **Anus:** Anus is a small aperture that opens on the mid-dorsal side of 26<sup>th</sup> segment.
- (iii) **Nephridiopores:** Nephridia open to the exterior by 17 pairs of nephridiopores. They lie ventrally on the last annulus of each segment from 6 to 22.
- (iv) **Male genital pore:** It is a mid-ventral opening, situated between second and third annuli of 10<sup>th</sup> segment.

**Activity 1**

- (i) Observe the external morphology of leech specimen in your biology laboratory.
- (ii) Can you find leeches in your locality?
- (iii) In which geographical areas are leeches found more predominantly in India?

- (v) **Female genital pore:** It lies mid-ventrally between second and third annuli of 11<sup>th</sup> segment.

**13.1.3 Divisions of the Body**

The body of leech is divided into six regions.

Region	Segments
Cephalic region	1 <sup>st</sup> - 5 <sup>th</sup>
Pre-clitellar region	6 <sup>th</sup> , 7 <sup>th</sup> and 8 <sup>th</sup>
Clitellar region	9 <sup>th</sup> , 10 <sup>th</sup> and 11 <sup>th</sup>
Middle region	12 <sup>th</sup> - 22 <sup>nd</sup>
Caudal region	23 <sup>rd</sup> - 26 <sup>th</sup>
Posterior sucker	27 <sup>th</sup> - 33 <sup>rd</sup>

**13.1.4 Body wall**

Body wall of leech includes five layers: (i) **cuticle** (outermost layer) (ii) **epidermis** which lies below the cuticle (iii) **dermis** which lies below the epidermis formed of connective tissue (iv) **muscular layer** formed of circular and longitudinal muscles (v) **botryoidal tissue** lies beneath longitudinal muscles and fills the entire coelom around the gut.

**13.1.5 Locomotion**

Locomotion in leech takes place by (i) looping or crawling movement (ii) Swimming movement.

**(i) Looping or Crawling movement**

This type of movement is brought about by the contraction and relaxation of muscles. The two suckers serve for attachment during movement on a substratum.

**(ii) Swimming movement**

Leeches swim very actively and perform undulating movements in water.

**13.1.6 Digestive System**

The digestive system includes the long alimentary canal and the digestive glands.

**Alimentary Canal**

The alimentary canal of leech is a straight tube running from the mouth to the anus. **Mouth** is a **triradiate** aperture situated in the middle of the anterior sucker that leads into the small buccal cavity. The wall of the buccal cavity bears three jaws with single row of minute teeth. The jaws are provided with **papillae** which bear the openings of salivary glands. Mouth and buccal cavity occupy the first five segments.

The buccal cavity leads into muscular **pharynx**. It is surrounded by salivary glands. The secretion of saliva contains **hirudin** which prevents the coagulation of blood. Pharynx leads into crop through a short and narrow **oesophagus**.

**Crop** is the largest portion of the alimentary canal. It is divided into a series of 10 chambers. The chambers communicate with one another through circular apertures surrounded by **sphincters**. A pair of lateral, backwardly directed caecae arises as blind outgrowth from each chamber known as **caeca** or **diverticula**. Crop and its diverticula can store large amount of blood which can be slowly digested.

The last chamber of crop opens into stomach. The stomach leads into **intestine** which is a small straight tube that opens into **rectum**. The rectum opens to the exterior by anus.

### Food, Feeding and Digestion

The leech feeds by sucking the blood of cattle and other domestic animals. During feeding the leech attaches itself to its victim strongly by the posterior sucker. The leech makes a **triradiate** or **Y shaped incision** in the skin of the host by the jaws protruded through the mouth. The blood is sucked by muscular pharynx and the salivary secretion is poured.

The ingested blood is stored in crop chambers and its diverticulum. The blood passes from the crop into the stomach. Digestion takes place in stomach by the action of proteolytic enzyme. The digested blood is then absorbed slowly by the intestine. Undigested food is stored in rectum and egested through anus.

Leeches prevent blood clotting by secreting a protein called **hirudin**. They also inject an anaesthetic substance that prevents the host from feeling their bite.

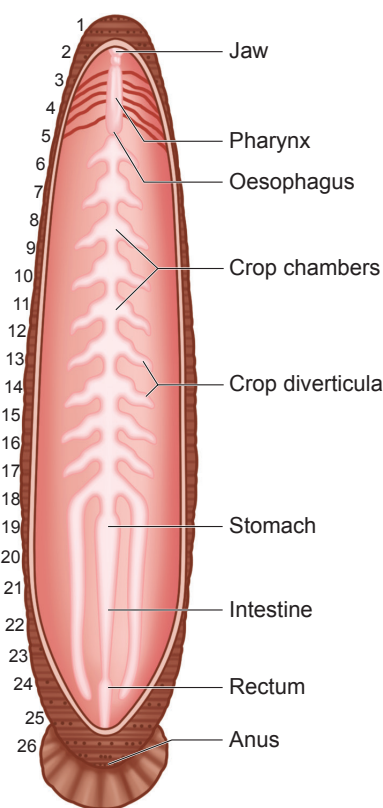

Figure 13.2 Digestive system of Leech

### More to Know

- ◆ Leeches do not have ear, hence can sense vibrations through their skin.
- ◆ Leeches have 2 to 10 tiny eyes, which helps them to locate their food.
- ◆ Leeches can suck blood five times more than their body weight.
- ◆ It may take more than a year for the complete digestion and absorption of a full meal.

Table 13.1 Segmentation of Leech

External and Internal features	Segments in which the structures are present
Body segments	33
Anterior Sucker, Mouth, Eyes	1 <sup>st</sup> - 5 <sup>th</sup>
Posterior sucker	27 <sup>th</sup> - 33 <sup>rd</sup>
Pharynx	5 <sup>th</sup> - 8 <sup>th</sup>
Crop	9 <sup>th</sup> - 18 <sup>th</sup>
Stomach	19 <sup>th</sup>
Intestine	10 <sup>th</sup> - 22 <sup>nd</sup>
Rectum	23 <sup>rd</sup> - 26 <sup>th</sup>
Anus	26 <sup>th</sup>
Nephridiopores	6 <sup>th</sup> - 22 <sup>nd</sup>
Male genital aperture	10 <sup>th</sup>
Female genital aperture	11 <sup>th</sup>

### 13.1.7 Respiratory System

Respiration takes place through the **skin** in leech. Dense network of tiny blood vessels called as **capillaries** containing the haemocoelic fluid extend in between the cells of the epidermis. The exchange of respiratory gases takes place by diffusion. Oxygen dissolved in water diffuses through the skin into haemocoelic fluid, while

carbon dioxide diffuses out. The skin is kept moist and slimy due to secretion of mucus which also prevents it from drying.

### 13.1.8 Circulatory System

In leech, circulation is brought about by **haemocoelic system**. There are no true blood vessels. The blood vessels are replaced by channels called **haemocoelic channels** or **canals** filled with blood like fluid. The coelomic fluid contains haemoglobin.

There are four longitudinal channels. One channel lies above (dorsal) the alimentary canal, one below (ventral) the alimentary canal. The other two channels lie on either (lateral) side of the alimentary canal which serve as heart and have inner valves. All the four channels are connected together posteriorly in the 26<sup>th</sup> segment.

### 13.1.9 Nervous System

The central nervous system of leech consists of a nerve ring and a paired ventral nerve cord. The nerve ring surrounds the pharynx

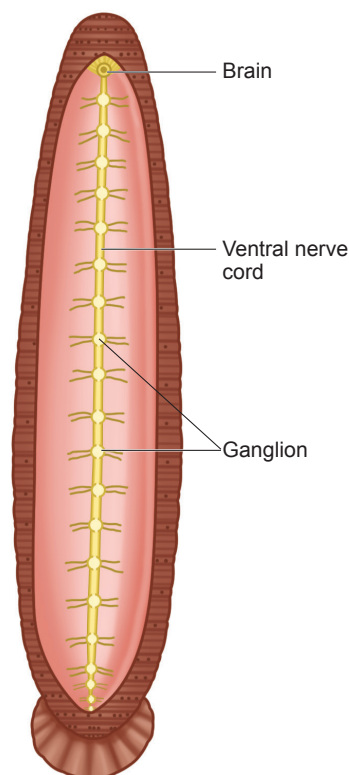

Figure 13.3 Nervous system of Leech

and is formed of **suprapharyngeal ganglion** (brain), **circumpharyngeal connective** and **subpharyngeal ganglion**. The subpharyngeal ganglion lies below the pharynx and is formed by the fusion of four pairs of ganglia.

### 13.1.10 Excretory System

In leech, excretion takes place by segmentally arranged paired tubules called **nephridia**. There are 17 pairs of nephridia which open out by **nephridiopores** from 6<sup>th</sup> to 22<sup>nd</sup> segments.

### 13.1.11 Reproductive System

Leech is hermaphrodite because both the male and female reproductive organs are present in the same animal.

#### Male Reproductive System

There are eleven pairs of testes, one pair in each segment from 12 to 22 segments. They are in the form of spherical sacs called **testes sacs**. From each testis arises a short duct called **vas efferens**, which join with the vas deferens. The vas deferens becomes convoluted to form the **epididymis** or **sperm vesicle**, to store spermatozoa.

The epididymis leads to a short duct called ejaculatory duct. The **ejaculatory ducts** on both sides join to form the **genital atrium**. The atrium consists of two regions, the coiled prostate glands and the penial sac consisting of penis that opens through the male genital pore.

#### Female Reproductive System

It consists of ovaries, oviducts and vagina. There is a single pair of ovary in the 11<sup>th</sup> segment on the ventral side. Each ovary is a coiled ribbon-shaped structure.

The ova are budded off from the ovary. From each **ovary** runs a short oviduct. The **oviducts** of the two sides joins together, to form a common oviduct. The common oviduct opens into a pear-shaped **vagina** which lies mid-ventrally in the posterior part of the 11<sup>th</sup> segment.

**Development**

- (i) Internal fertilization takes place. This is followed by cocoon formation. **Cocoon** is also known as **egg case** which is formed around the 9<sup>th</sup>, 10<sup>th</sup> and 11<sup>th</sup> segments.
- (ii) Development is direct and proceeds in cocoon which contain one to 24 embryos.
- (iii) Young leech resembling the adult emerges.

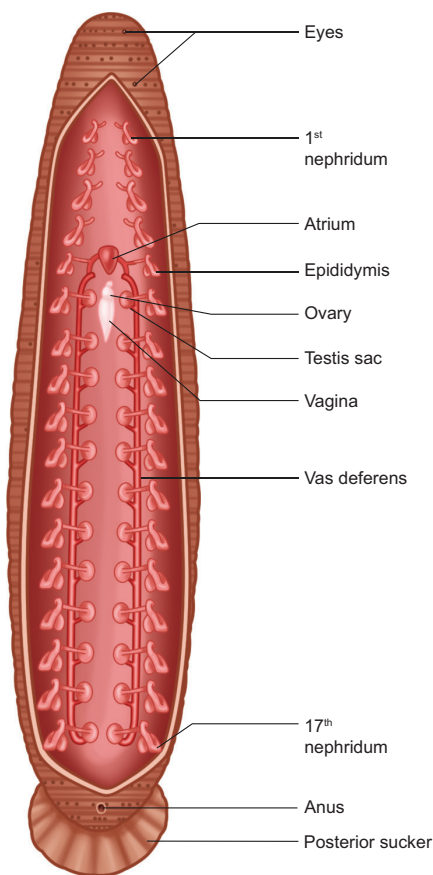

**Figure 13.4** Reproductive system of Leech

**More to Know**

**Medicinal value of Leech**

Leeches are effective in increasing blood circulation and breaking up blood clots. It is surprising that they can be used to treat cardiovascular diseases. Biochemical substances derived from leech saliva are used for preparation of pharmaceutical drugs that can treat hypertension.

**13.1.12 Parasitic Adaptations of Leech**

Leeches lead a parasitic mode of life by sucking the blood of vertebrates and show several important adaptations in their structure.



1. Blood is sucked by pharynx.
2. Anterior and posterior ends of the body are provided with suckers by which the animal attaches itself to the body of the host.
3. The three jaws inside the mouth, causes a painless Y-shaped wound in the skin of the host.
4. The salivary glands produce hirudin which does not allow the blood to coagulate. Thus, a continuous supply of the blood is maintained.
5. Parapodia and setae are completely absent
6. Blood is stored in the crop. It gives nourishment to the leech for several months. Due to this reason there is no elaborate secretion of the digestive juices and enzymes.



Blood letting is a technique of bleeding in a patient to remove toxic impurities from the body.

**13.2 Rabbit (*Oryctolagus cuniculus*)**

**Taxonomic Position**

Phylum	Chordata
Sub-phylum	Vertebrata
Class	Mammalia
Order	Lagomorpha
Genus	<i>Oryctolagus</i>
Species	<i>cuniculus</i>

**13.2.1 Habit and Habitat**

Rabbits are gentle and timid animals. They show leaping movement and live in burrows.



They are distributed throughout the world. They are herbivorous animals feeding on grass and vegetables like turnips, carrots and lettuce. Rabbits are **gregarious** (moving in groups) animals



The pygmy rabbit was listed as a threatened species in Washington in 1990, because of decline in its population size and distribution due to habitat loss. In March 2003, the Columbia Basin Pygmy Rabbit was federally listed as an endangered species.

### 13.2.2 External Morphology

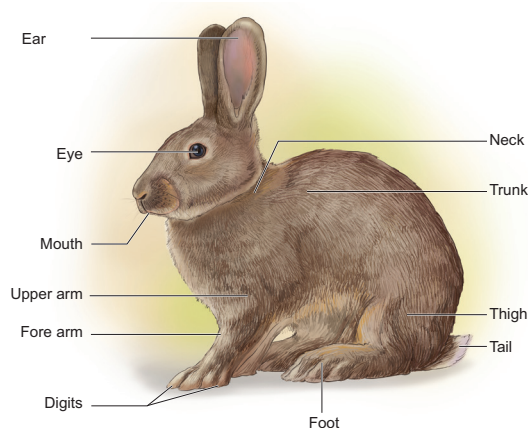

Figure 13.5 Rabbit- External features

**Shape, Size and Colouration:** It has an elongated and cylindrical body. Males and females are of the same size. They grow about 45 cm in length and weigh about 2.25 kg as adult. The colour varies from white to black and white. Body is covered with fur which serves to keep it warm.

**Body-division:** The body of the rabbit is divisible into the head, neck, trunk and tail.

**Head:** Head is ovoid, flattened and bears a truncate snout. It contains mouth, external nares, eyes, ears and vibrissae. The **mouth** is a transverse slit-like bounded by upper lip and lower lip. Just above the mouth are two oblique openings called **nostrils**. From each side of the upper lip tactile hairs or **vibrissae** (whiskers) project outwards. A pair of large, movable

**external ear** or **pinnae** is situated at the top of the head.

**Neck:** The neck connects the head with the trunk. It helps to turn the head.

**Trunk:** The trunk is divisible into an anterior **thorax** and a posterior **abdomen**. In females, four or five **teats** or **nipples** are present on the ventral surface between the thorax and abdomen.

The trunk bears two pairs of **pentadactyl limbs**. The forelimbs are shorter than the hind limbs. All the digits bear claws.

The anus is present at the posterior end of the abdomen at the base of tail. In females on the ventral side a slit like **vulva** is present. In males **penis** is present in the ventral side of anus. The male has a pair of testes enclosed by **scrotal sacs**.

**Tail:** The tail is short. It is used to give signals to other rabbits in the event of danger.

**Integument (Skin):** The integument forms the outer covering of the body. The structures which are derived from it are **hairs, claws, nails** and glands like **sweat glands, sebaceous glands** and **mammary glands**.

Mammary glands are modified glands of the skin. They secrete milk and help in nourishing young ones. The sweat glands and sebaceous glands embedded in the skin regulate the body temperature.

### 13.2.3 Coelom (Body cavity)

Rabbit is a coelomate animal. The body is divisible into **thoracic cavity** and **abdominal cavity** separated by transverse partition called **diaphragm**. Diaphragm is the characteristic feature of mammals. Breathing movements are brought by the movement of the diaphragm.

Lungs and heart lie in the thoracic cavity, whereas, abdominal cavity encloses digestive and urinogenital system.

### 13.2.4 Digestive System

The digestive system includes the **alimentary canal** and the **associated digestive glands**. The alimentary canal consists of mouth, buccal cavity, pharynx, oesophagus, stomach, small intestine, caecum, large intestine and anus.

Mouth is a transverse slit bounded by upper and lower lips. It leads into the **buccal cavity**. The floor of the buccal cavity is occupied by a muscular tongue. Jaws bear teeth.

The buccal cavity leads into the oesophagus through the pharynx. **Oesophagus** opens into the stomach followed by small intestine. **Caecum** is a thin walled sac present at the junction of small intestine and large intestine. It contains bacteria that helps in **digestion of cellulose**. The **small intestine** opens into the **large intestine** which has **colon** and **rectum**. The rectum finally opens outside by the anus.

#### Digestive glands

The digestive glands are salivary glands, gastric glands, liver, pancreas and intestinal glands. The secretions of digestive glands help in digestion of food in the alimentary canal.

#### Dentition in Rabbit

Teeth are hard bone-like structures used to cut, tear and grind the food materials. The

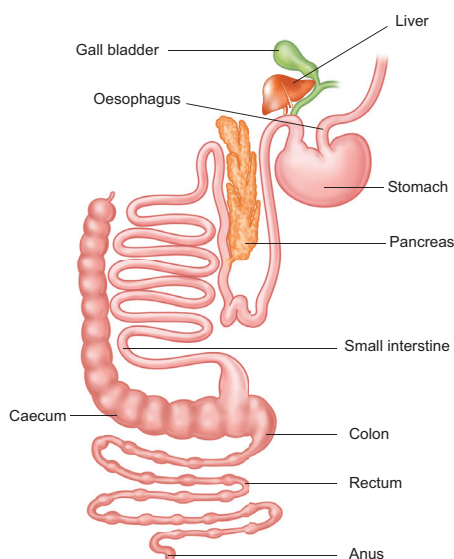

Figure 13.6 Digestive System of Rabbit

rabbit has two sets of teeth. The existence of two sets of teeth in the life of an animal is called **diphyodont dentition**. The two types of teeth are **milk teeth** (young ones) and **permanent teeth** (in adults).

In rabbit the teeth are of different types. Hence, the dentition is called **heterodont**. There are four kinds of teeth in mammals viz. the **incisors** (I), **canines** (C), **premolars** (PM) and **molars** (M). This is expressed in the form of a dental formula.

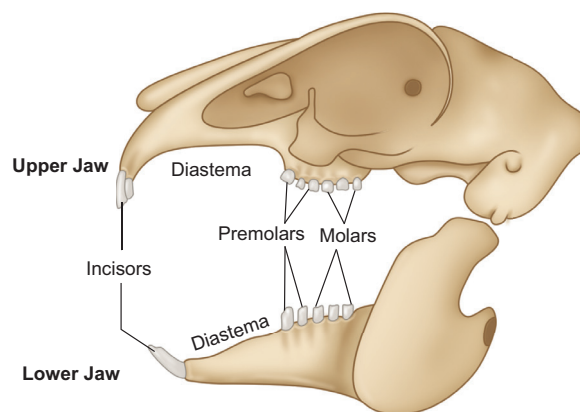

Figure 13.7 Dentition of Rabbit (Arrangement of teeth in jaws)

Dental formula is the simple method of representing the teeth of a mammal. The number of each kind of tooth in the upper and the lower jaws on one side is counted.

Dental formula is  $(I \frac{2}{1}, C \frac{0}{0}, PM. \frac{3}{2}, M \frac{3}{3})$  in rabbit which is written as  $\frac{2033}{1023}$ . Canines are absent. The gap between the incisors and premolar is called **diastema**. It helps in mastication and chewing of food in herbivorous animals.

### 13.2.5 Respiratory System

Respiration takes place by a pair of **lungs**, which are light spongy tissues enclosed in the thoracic cavity. The thoracic cavity is bound dorsally by the vertebral column and ventrally by the sternum, laterally by the ribs. On the lower side of the thoracic cavity is the dome shaped **diaphragm**.

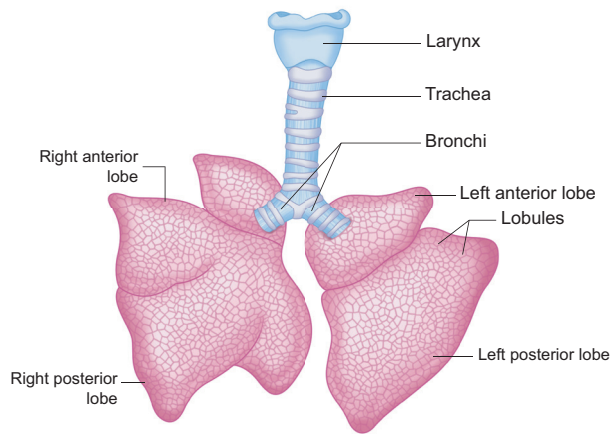

**Fig. 13.8** Lungs of Rabbit

Each lung is enclosed by a double membranous **pleura**. Atmospheric air passes through the external nostril and nasal passages into the pharynx. From the pharynx it passes through the glottis into the wind pipe.

The anterior part of the wind pipe is enlarged to form the **larynx** or **voice box** with its wall supported by four cartilaginous plates. Inside the larynx lies the vocal cord and its vibrations result in the production of sound. The larynx leads into **trachea** or **wind pipe**.

Tracheal walls are supported by rings of cartilage which help in the free passage of air. The **epiglottis** prevents the entry of food into the trachea through the glottis. The trachea divides into two branches called the **bronchi** one entering into each lung and dividing into further branches called **bronchioles** which end in alveoli.

The respiratory events consist of **inspiration** (breathing in) and **expiration** (breathing out) allowing exchange of gases (oxygen and carbon dioxide). Inspiration is an active process while expiration is a passive process.

### 13.2.6 Circulatory System

The circulatory system is formed of blood, blood vessels and heart. The heart is pear shaped and lies in the thoracic cavity in between the lungs. It is enclosed by **pericardium**, a double layered membrane.

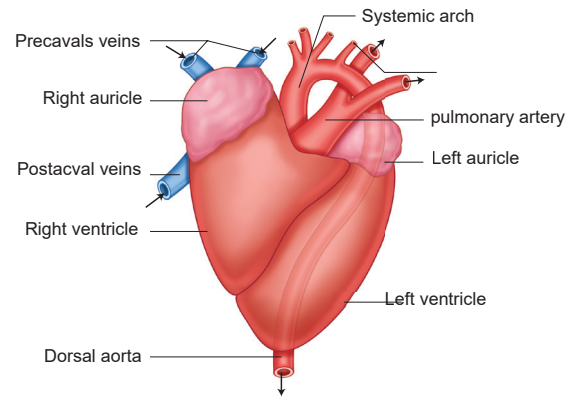

**Fig. 13.9** Heart of Rabbit - Ventral View

The heart is four chambered with two auricles and two ventricles. The right and left auricles are separated by **interauricular septum**, similarly right and left ventricles are separated by **interventricular septum**.

The right auricle opens into the right ventricle by right **auriculoventricular aperture**, guarded by a **tricuspid valve**. The left auricle opens into the left ventricle by left auriculoventricular aperture guarded by a **bicuspid valve** or **mitral valve**. The opening of the pulmonary artery and aorta are guarded by three **semilunar valves**.

The right auricle receives deoxygenated blood through two **precaval** (superior vena cava) and one **postcaval** (inferior vena cava) veins from all parts of the body. The left auricle receives oxygenated blood from the pulmonary veins from the lungs. From the right ventricle arises pulmonary trunk which carries the deoxygenated blood to the lungs and from the left ventricle arises the systemic arch (aorta) which supplies oxygenated blood to all parts of the body.

### 13.2.7 Nervous System

The nervous system in rabbit is formed of the central nervous system (CNS), peripheral nervous system (PNS) and autonomic nervous system (ANS).

CNS consists of brain and spinal cord. PNS is formed of 12 pairs of cranial nerves and 37 pairs of spinal nerves. ANS comprises sympathetic and parasympathetic nerves.

Brain is situated in the cranial cavity and covered by three membranes called an outer **duramater**, an inner **piamater** and a middle **arachnoid membrane**. The brain is divided into **forebrain** (prosencephalon), **midbrain** (mesencephalon) and **hindbrain** (rhombencephalon).

Forebrain consists of a pair of olfactory lobes, cerebral hemispheres and diencephalon. The right and left cerebral hemispheres are connected by transverse band of nerve tissue called **corpus callosum**.

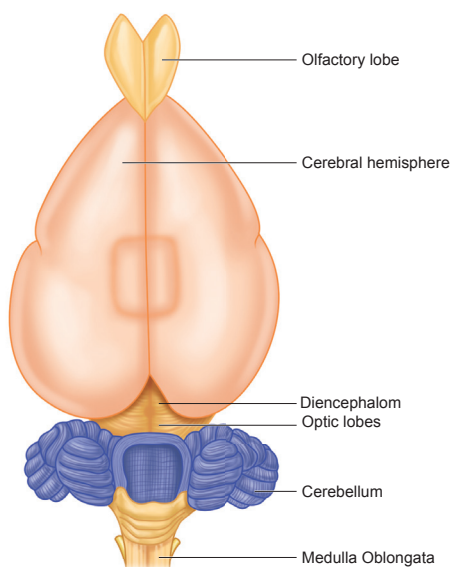

Fig. 13.10 Brain of Rabbit (Dorsal view)

The midbrain includes the optic lobes. The hindbrain consists of the cerebellum, pons varolii and medulla oblongata. You will study about the details of mammalian brain in the chapter on nervous system.

### 13.2.8 Urinogenital System

It comprises the urinary or excretory system and the genital or reproductive system. Therefore, they are usually described as urinogenital system in vertebrates.

#### Excretory system

Each kidney is made of several nephrons. It separates the nitrogenous wastes from blood and excretes it in the form of urea. Kidneys

are dark red, bean shaped organs situated in the abdominal cavity. From each kidney arises the **ureters** which open posteriorly into the **urinary bladder** and leads into a thick walled muscular duct called **urethra**.

#### Reproductive System

Sexual dimorphism is exhibited in rabbits. The male and female sexes are separate and are morphologically different.

#### Male Reproductive system

The male reproductive system of rabbit consists of a pair of testes which are ovoid in shape. Testes are enclosed by scrotal sacs in the abdominal cavity. Each testis consists of numerous fine tubules called **seminiferous tubules**. This network of tubules lead into a coiled tubule called **epididymis**, which lead into the sperm duct called **vas deferens**. The vas deferens join in the urethra just below the urinary bladder. The urethra runs backward and passes into the penis.

There are three accessory glands namely prostate gland, cowper's gland and perineal gland. Their secretions are involved in reproduction.

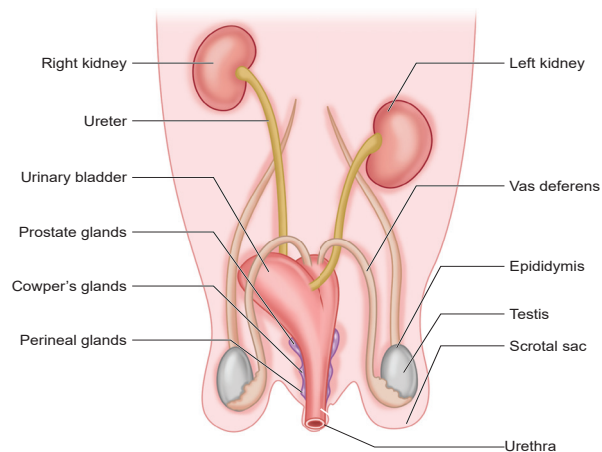

Fig. 13.11 Male reproductive system of Rabbit

#### Female reproductive system

The female reproductive system of rabbit consists of a pair of ovaries which are small

ovoid structures. They are located behind the kidneys in the abdominal cavity.

A pair of oviducts opens into the body cavity by a funnel shaped opening from each side of the ovary. The anterior part of the oviduct is the fallopian tube. It leads into a wider tube called the **uterus**. The uterus join together to form a median tube called **vagina**. The common tube is formed by the union of urinary bladder and the vagina and is called the **urinogenital canal** or **vestibule**. It runs backwards and opens to the exterior by a slit-like aperture called **vulva**.

A pair of **Cowper's gland** and **perineal gland** are the accessory glands present in the female reproductive system.

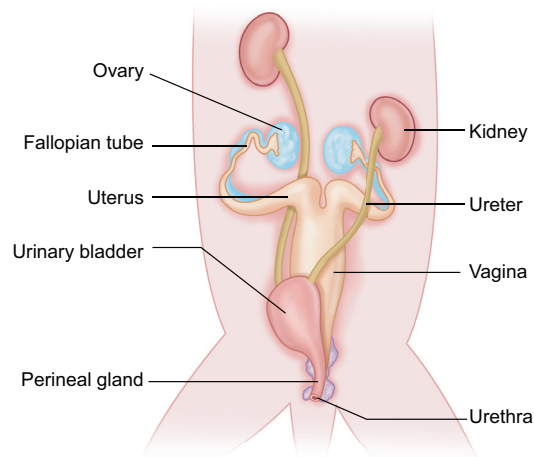

Fig. 13.12 Female reproductive system of Rabbit

Points to Remember

- ❖ Leech is metamerically segmented and has 33 segments.
- ❖ It has two suckers which are used to attach to the body of the host. It is also involved in locomotion.
- ❖ The salivary glands of leech produce an anticoagulating substance called hirudin.
- ❖ Leech is a hermaphrodite.

- ❖ Rabbits are warm blooded vertebrates.
- ❖ Canine teeth are absent in rabbit.
- ❖ Respiration takes place through a pair of lungs in rabbit.
- ❖ The heart is four chambered consisting of two auricles and two ventricles.
- ❖ Urinogenital system comprises the urinary (or) excretory system and the genital (or) reproductive system.
- ❖ Mammary glands are modified glands of the skin and help in nourishing the young ones.



TEXTBOOK EVALUATION



I. Choose the correct answer

1. In leech locomotion is performed by
  - a) Anterior sucker
  - b) Parapodia
  - c) Setae
  - d) Contraction and relaxation of muscles
2. The segments of leech are known as
  - a) Metameres (somites)
  - b) Proglottids
  - c) Strobila
  - d) All the above
3. Pharyngeal ganglion in leech is a part of
  - a) Excretory system
  - b) Nervous system
  - c) Reproductive system
  - d) Respiratory system
4. The brain of leech lies above the
  - a) Mouth
  - b) Buccal Cavity
  - c) Pharynx
  - d) Crop
5. The body of leech has
  - a) 23 segments
  - b) 33 segments
  - c) 38 segments
  - d) 30 segments
6. Mammals are \_\_\_\_\_ animals.
  - a) Cold blooded
  - b) Warm blooded
  - c) Poikilothermic
  - d) All the above

7. The animals which give birth to young ones are  
 a) Oviparous                      b) Viviparous  
 c) Ovoviviparous                d) All the above

**II. Fill in the blanks**

- The posterior sucker is formed by the fusion of the \_\_\_\_\_ segments.
- The existence of two sets of teeth in the life of an animal is called \_\_\_\_\_ dentition.
- The anterior end of leech has a lobe-like structure called \_\_\_\_\_.
- The blood sucking habit of leech is known as \_\_\_\_\_.
- \_\_\_\_\_ separate nitrogenous waste from the blood in rabbit.
- \_\_\_\_\_ spinal nerves are present in rabbit.

**III. Identify whether the statements are True or False. Correct the false statement**

- An anticoagulant present in saliva of leech is called heparin.
- The vas deferens serves to transport the ovum.
- Diastema is a gap between premolar and molar teeth in rabbit.
- The cerebral hemispheres of rabbit are connected by band of nerve tissue called corpora quadrigemina.

**IV. Match columns I, II and III correctly**

Organs	Membranous Covering	Location
Brain	pleura	abdominal cavity
Kidney	capsule	mediastinum
Heart	meninges	enclosed in thoracic cavity
Lungs	pericardium	cranial cavity

**V. Answer in a sentence**

- Give the common name of the *Hirudinaria granulosa*.
- How does leech respire?
- Write the dental formula of rabbit.
- How many pairs of testes are present in leech?
- How is diastema formed in rabbit?
- What organs are attached to the two bronchi?
- Which organ acts as suction pump in leech?
- What does CNS stand for?
- Why is the teeth of rabbit called heterodont?
- How does leech suck blood from the host?

**VI. Short answer questions**

- Why are the rings of cartilages found in trachea of rabbit?
- List out the parasitic adaptations in leech.

**VII. Long answer questions**

- How is the circulatory system designed in leech to compensate the heart structure ?
- How does locomotion take place in leech?
- Explain the male reproductive system of rabbit with a labelled diagram.

**VIII. Higher Order Thinking Skills (HOTS)**

- Arjun is studying in tenth standard. He was down with fever and went to meet the doctor. As he went to the clinic he saw a patient undergoing treatment for severe leech bite. Being curious, Arjun asked the doctor why leech bite was not felt as soon as it attaches to the skin ? What would have been the reply given by the doctor?
- Shylesh has some pet animals at his home. He has few rabbits too, one day while feeding them he observed something different with the teeth. He asked his grandfather, why is it so? What would have been the explanation of his grandfather?

**IX. Value based questions**

1. Leeches do not have an elaborate secretion of digestive juices and enzymes -Why ?
2. How is the digestive system of rabbit suited for herbivorous mode of feeding?

3. Kotpal R.L, 2012 Modern Text Book of Zoology -Vertebrates, Rastogi Publications, Meerut
4. Jordan E.L. and Verma P.S. 2003 Chordate Zoology, S. Chand and Company Ltd, New Delhi.



**REFERENCE BOOKS**

1. Kotpal R.L, 2014 Modern Text Book of Zoology -Invertebrates,Rastogi Publications, Meerut.
2. Ekambaranatha Ayyar M and Anantha krishnan T.N. 2003. Manual of Zoology, Vol I, Part I & II (Invertebrates), S. Viswanathan Printers and Publishers Pvt Ltd.



**INTERNET RESOURCES**

- <http://leeches-medicinalis.com/>
- <http://www.biologydiscussion.com/zoology>
- [http://animaldiversity.org/accounts/Hirudo\\_medicinalis/](http://animaldiversity.org/accounts/Hirudo_medicinalis/)
- <http://www.notesonzoology.com/rabbit/external-morphology/external-morphology-of-rabbit-with-diagram-chordata-zoology/7642>

**Concept Map**

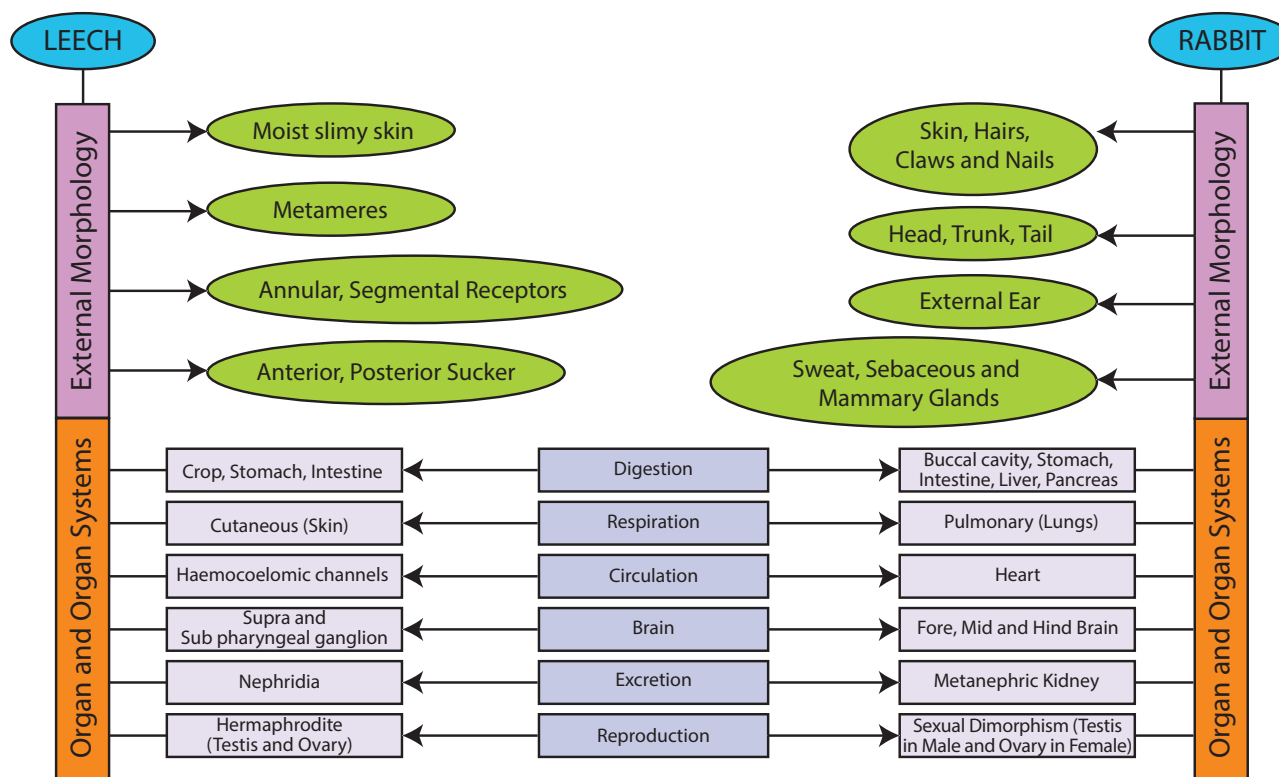

 UNIT  
14

 TRANSPORTATION IN PLANTS  
AND  
CIRCULATION IN ANIMALS

### Learning Objectives



At the end of this lesson the students will be able to :

- ◆ Learn how the water and minerals move from soil to the plant.
- ◆ Learn how prepared food by the leaf is translocated to various parts of the plant.
- ◆ Understand the role of osmosis and transpiration.
- ◆ Understand the composition of blood.
- ◆ Identify and explain the structure of heart and associated blood vessels.
- ◆ Understand systemic, pulmonary and coronary circulation.
- ◆ Differentiate the events of the cardiac cycle.
- ◆ Know about blood pressure and heart beat.
- ◆ Understand the use of stethoscope and sphygmomanometer.
- ◆ Identify the different blood groups.
- ◆ Understand the role of lymphatic system.

### Introduction

Multicellular organisms possess millions of cells in their body. Every cell needs a constant supply of essential substances like nutrients and oxygen to maintain life and survival. Food is the only source of energy and every cell gets its energy by the breakdown of glucose. The cells utilise this energy and govern various vital activities of life.

Have you ever wondered how water and nutrients absorbed by the root are transported to the leaves? How is the food prepared by the leaves carried to the other parts of the plant? Do you know how water reaches the top of tall plants inspite of not having a circulatory system like animals? Water absorbed by the roots have to reach entire plant and the food synthesised by the leaves have to be distributed to all the parts

of the plant. To understand this we need to recall the anatomy of the plants. Water and mineral salts absorbed by the roots reach all parts of the plant through the xylem. The food synthesised by the leaves are translocated to all parts of the plant through the phloem. The bulk movement of substances through the vascular tissue is called Translocation.

‘Transport’ means to carry things from one place to another. Have you ever wondered how in animals the useful substances are transported to other cells and toxic substances are removed? In larger organisms transport of nutrients, salts, oxygen, hormones and waste products around the body are performed by the ‘**Circulatory system**’. The circulatory system consists of the circulating fluids, **the blood and lymph** and **the heart and blood vessels** which form the collecting and transporting system.



## 14.1 Means of Transport in Plants

The transport of materials in and out of the cells is carried out by diffusion and active transport in plants.

### 14.1.1 Diffusion

The movement of solid liquid and gaseous molecules from a region of higher concentration to a region of their lower concentration without the utilization of energy is called **diffusion**. This is a passive process.

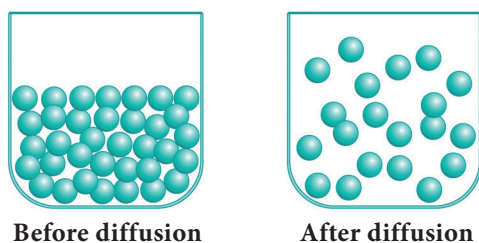

Figure 14.1 Diffusion

### 14.1.2 Active Transport

Active transport utilizes energy to pump molecules against a concentration gradient. Active transport is carried out by membrane bound proteins. These proteins use energy to carry substances across the cell membrane hence they are often referred to as **pumps**. These pumps can transport substances from a low concentration to a high concentration ('uphill' transport).

### 14.1.3 Osmosis

Osmosis is the **movement of solvent** or water molecules from the **region of higher concentration** to the region of lower concentration through a semi-permeable membrane. This process is carried out till an equilibrium is reached. Osmosis is the passive movement of water or any other solvent molecules.

#### Plasmolysis

It occurs when a living plant cell is placed in a hypertonic solution water molecule moves out of the cell and resulting in the shrinkage of protoplasm away from the cell wall.

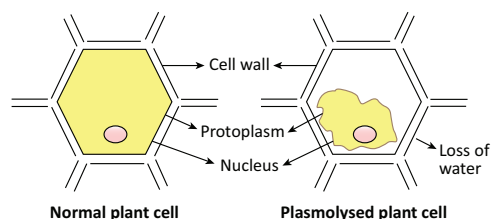
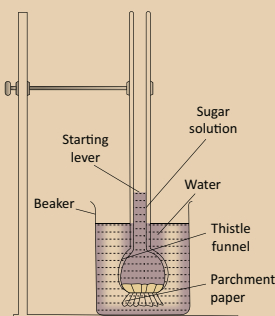

Figure 14.2 Plasmolysis

### Activity 1

#### Demonstration of Osmosis

A thistle funnel whose mouth is covered with a semipermeable membrane, is filled with sucrose solution. It is kept inverted in a beaker containing water. The water will diffuse across the membrane due to osmosis and raise the level of the solution in the funnel.



#### Imbibition

**Imbibition** is a type of diffusion in which a solid plant material absorbs water and gets swelled up. eg. absorption of water by dry seeds and grapes. If it were not for imbibition, seedlings would not have been able to emerge out of the soil.

## 14.2 Root Hair-Water Absorbing Unit

There are millions of root hairs on the tip of the root which absorb water and minerals by diffusion. Root hairs are thin walled, slender extension of epidermal cell that increase the surface area of absorption.

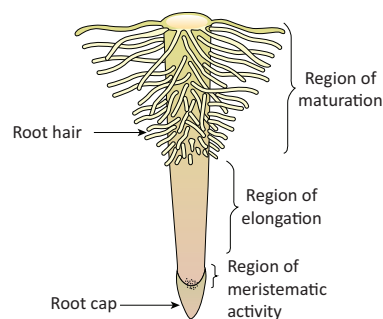

Figure 14.3 Root Tip with Root Hairs

### 14.3 Pathway of Water Absorbed by Roots

Once the water enters the root hairs, the concentration of water molecules in the root hair cells become more than that of the cortex. Thus water from the root hair moves to the cortical cells by osmosis and then reaches the xylem. From there the water is transported to the stem and leaves.

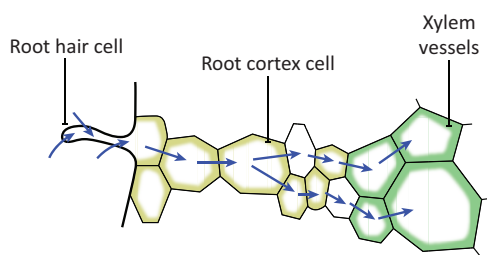

Figure 14.4 T. S. of the root showing movement of water from soil to xylem

### 14.4 Types of Movement of Water into the Root Cells

Once water is absorbed by the root hairs, it can move deeper into root layers by two distinct pathways:

- Apoplast pathway
- Symplast pathway

#### 14.4.1 Apoplast Pathway

The **apoplastic** movement of water occurs exclusively through the intercellular spaces and the walls of the cells. Apoplastic movement does not involve crossing the cell membrane. This movement is dependent on the gradient.

#### 14.4.2 Symplast Pathway

In this method, water molecules move to the adjacent cells, through the plasma membrane, cytoplasm and plasmodesmata. This method of transport is slow as water moves through plasma membrane. It is in accordance to the concentration gradient.

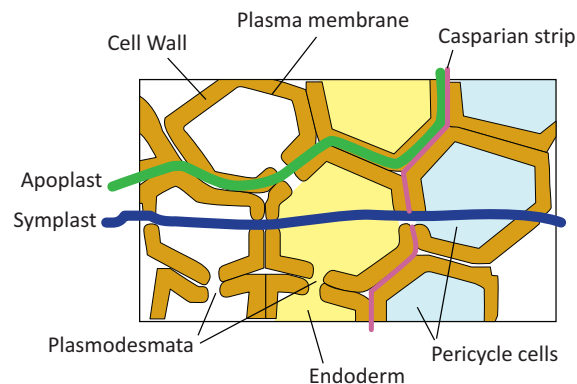

Figure 14.5 Symplastic and Apoplastic pathways of Water

### 14.5 Transpiration

Transpiration is the evaporation of water from the aerial parts of the plant especially through stomata in leaves. Stomata are open in the day and closed at night. The opening and closing of the stomata is due to the change in turgidity of the guard cells. When water enters into the guard cells, they become turgid and the stoma open. When the guard cells lose water, it becomes flaccid and the stoma closes.

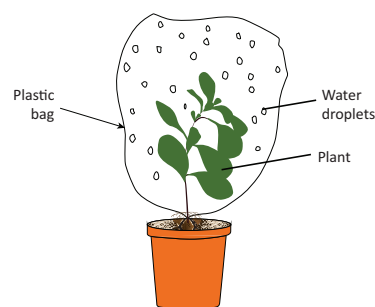

Figure. 14.6 Process of Transpiration

Water evaporates from mesophyll cells of leaves through the open stomata, this lowers water concentration in mesophyll cells. As a result, more water is drawn into these cells from the xylem present in the veins through the process of osmosis. As water is lost from the leaves, pressure is created at the top to pull more water from the xylem to the mesophyll cells, this process is called **transpiration pull**. This extends up to the roots causing the roots to absorb more water from the soil to ensure continuous flow of water from the roots to the leaves.

### 14.5.1 Factors affecting Transpiration

Transpiration is affected by several external factors such as temperature, light, humidity, and wind speed. Internal factors that affect transpiration include number and distribution of stomata, percentage of open stomata, water status of the plant, canopy structure etc.

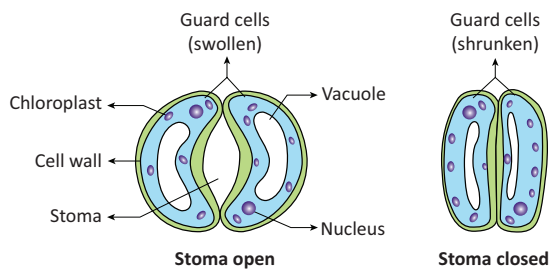

Figure. 14.7 Guard cell in turgid and flaccid condition

#### Significance of Transpiration

- Creates transpirational pull for transport of water
- Supplies water for photosynthesis
- Transports minerals from soil to all parts of the plant
- Cools the surface of the leaves by evaporation.
- Keeps the cells turgid; hence, maintains their shape

### 14.6 Root Pressure

As mineral ions from the soil are actively transported into the xylem tissue of the root, water moves along and increases the pressure inside the xylem. This pressure is called root pressure and is responsible for pushing water upward to some extent.

### 14.7 Uptake of Minerals

Plants depend on minerals from soil for its nutritional requirements. All minerals cannot be passively absorbed by the roots. Two factors account for this: (i) minerals are present in the

soil as charged particles (ions) that cannot move across cell membranes and (ii) the concentration of minerals in the soil is usually lower than the concentration of minerals in the root. Therefore, most minerals enter the root by active absorption through the cytoplasm of epidermal cells. This needs energy in the form of ATP. Then it is transported to all parts by transpiration pull.

### 14.8 Translocation of Mineral Ions

Minerals are remobilised from older dying leaves to younger leaves. This phenomenon can be seen in deciduous plants. Elements like phosphorus, sulphur, nitrogen and potassium are easily mobilised, while elements like calcium are not remobilised. Small amounts of material exchange takes place between xylem and phloem.

### 14.9 Phloem Transport

The food synthesised by the leaves are transported by the phloem either to the area of requirement or stored. Phloem tissue is composed of sieve tubes which have sieve plates. Cytoplasmic strands pass through the pores in the sieve plates.

Phloem transports food (sucrose) from a source to a sink. The source is part of the plant that synthesise food, i.e., the leaf, and sink, is the part that needs or stores the food. But, the source and sink may be reversed depending on the season, or the plant's need.

Since the source-sink relationship is variable, the direction of movement in the phloem can be upwards or downwards, i.e., **bidirectional**. In contrast, the movement is always **unidirectional** in xylem i.e., upwards.

### 14.10 Translocation of Sugars

The mechanism of translocation of sugars from source to sink is through pressure flow hypothesis. Glucose prepared at source (by

photosynthesis) is converted to sucrose. Sucrose moves into the companion cells, then into the living phloem sieve tube cells by active transport. This process produces a hypertonic condition in the phloem. Water in the adjacent xylem moves into the phloem by osmosis. As osmotic pressure builds up, the phloem sap moves to areas of lower pressure. By active transport sucrose moves into the cells where it is utilised or stored. As sugars are removed, the osmotic pressure decreases and water moves out of the phloem.

### 14.11 Ascent of Sap and its Events – An Overview

The upward movement of water and minerals from roots to different plant parts is called ascent of sap. A number of factors play a role in ascent of sap and it takes places in following steps

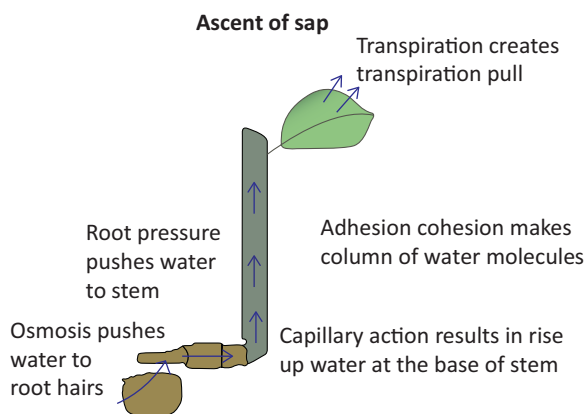

Figure 14.8 Ascent of Sap

- 1. Root Pressure:** Water from soil enters the root hairs due to osmosis. Root pressure is responsible for movement of water up to the base of the stem.
- 2. Capillary Action:** Water or any liquid rises in a capillary tube because of physical forces, this phenomenon is called capillary action. In the same way, in stem water rises up to certain height because of capillary action.
- 3. Adhesion-cohesion of Water Molecules:** Water molecules form a continuous column

in the xylem because of forces of adhesion and cohesion among the molecules.

- 4. Cohesion:** The force of attraction between molecules of water is called cohesion.
- 5. Adhesion:** The force of attraction between molecules of different substances is called adhesion. Water molecules stick to a xylem because of force of adhesion.

#### More to Know

Dews like water droplets on the leaves of grass seen in the early mornings, when the climate is humid and excess of water is present in the plants, the excess water is exudated in the form of liquid. This is due to root pressure. This phenomenon is called **Guttation** which takes place through specialized cells called **Hydathodes**.

**Transpiration Pull:** Transpiration through stomata creates vacuum which creates a suction, called transpiration pull. The transpiration pull sucks the water column from the xylem tubes and thus water is able to rise to great heights even in the tallest plants.

#### Activity 2

##### Demonstration of Root Pressure

Choose a small soft stemmed plant. Cut the stem horizontally near the base with a blade in the morning. You will see drops of solution oozing out of the cut stem due to root pressure.

### 14.12 Blood

Blood is the main circulatory medium in the human body. It is a red coloured fluid connective tissue.

**Components of Blood:** The blood consists of two main components. The fluid **plasma** and the **formed elements** (blood cells) which are found suspended in the plasma.

**Plasma:** It is slightly alkaline, containing non-cellular substance which constitutes about 55% of the blood. Organic substances like proteins, glucose, urea, enzymes, hormones, vitamins and minerals are present in the plasma.

**Formed Elements of Blood:** Blood corpuscles are of three types

1. **Red blood corpuscles (RBC) or Erythrocytes**
2. **White blood corpuscles (WBC) or Leucocytes**
3. **Blood platelets or Thrombocytes.**

**Red blood corpuscles (Erythrocytes)**

They are the most abundant cells in the human body. RBCs are formed in the bone marrow. The RBCs impart red colour to the blood due to presence of respiratory pigment **haemoglobin**. Matured mammalian RBCs do not have cell organelles and nucleus. They are biconcave and disc-shaped. Their life span is about 120 days. RBC is involved in the transport of oxygen from lungs to tissues.



**Erythrocytes**

**DO YOU KNOW?** Why does mammalian RBC lack cell organelles and nucleus?

Mammalian RBC lack nucleus and makes the cells biconcave and increase surface area for oxygen binding, loss of mitochondria allows the RBC to transport all the oxygen to tissues, and loss of endoplasmic reticulum allows more flexibility for RBC to move through the narrow capillaries.

**White blood corpuscles (Leucocytes)**

WBC's are colourless. They do not have haemoglobin and are nucleated cells. It is found in the bone marrow, spleen, thymus and lymph nodes. They are capable of amoeboid movement

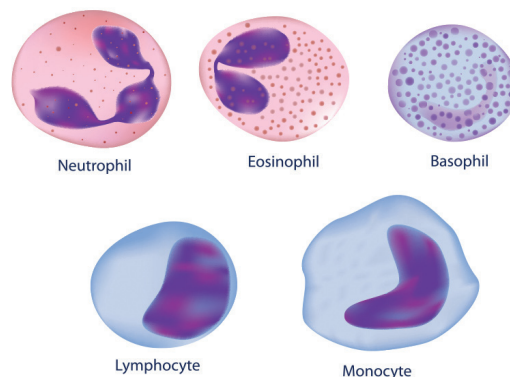

**Figure 14.9** Leucocytes

The white blood corpuscles can be grouped into two categories:

1. **Granulocytes**
2. **Agranulocytes.**

**Granulocytes**

They contain granules in their cytoplasm. Their nucleus is irregular or lobed. The granulocytes are of three types

- (i) Neutrophils
- (ii) Eosinophils
- (iii) Basophils

**(i) Neutrophils**

They are large in size and have a 2 - 7 lobed nucleus. These corpuscles form 60% - 65% of the total leucocytes. Their numbers are increased during **infection** and **inflammation**.

**(ii) Eosinophils**

It has a bilobed nucleus and constitute 2% - 3% of the total leucocytes. Their number increases during conditions of **allergy** and **parasitic infections**. It brings about detoxification of toxins.

**(iii) Basophils**

Basophils have lobed nucleus. They form 0.5-1.0% of the total leucocytes. They release chemicals during the process of **inflammation**.

**Agranulocytes**

Granules are not found in the cytoplasm of these cells. The agranulocytes are of two types:

- (i) Lymphocytes
- (ii) Monocytes

(i) **Lymphocytes**

These are about 20-25% of the total leucocytes. They produce **antibodies** during bacterial and viral infections.

(ii) **Monocytes**

They are the largest of the leucocytes and are amoeboid in shape. These cells form 5 - 6 % of the total leucocytes. They are **phagocytic** and can **engulf bacteria**.

**Blood Platelets or Thrombocytes**

These are small and colourless. They do not have nucleus. There are about 2,50,000 – 4,00,000 platelets / cubic mm of blood. Life span of **Thrombocytes** platelets is 8–10 days. They play an important role in clotting of blood. Platelets form clot at the site of injury and prevent blood loss.

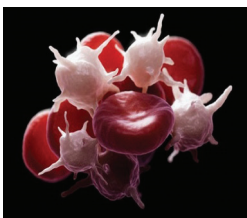

**More to Know**

- Anaemia:** Decrease in number of erythrocytes.
- Leucocytosis:** Increase in the number of leukocytes.
- Leukopenia:** Decrease in number of leukocytes.
- Thrombocytopenia:** Decrease in the number of thrombocytes.

**Functions of blood**

- i) Transport of respiratory gases (Oxygen and CO<sub>2</sub>).
- ii) Transport of digested food materials to the different body cells.
- iii) Transport of hormones.
- iv) Transport of nitrogenous excretory products like ammonia, urea and uric acid.
- v) It is involved in protection of the body and defense against diseases.
- vi) It acts as buffer and also helps in regulation of pH and body temperature.
- vii) It maintains proper water balance in the body.

**14.13 Blood Vessels - Arteries and Veins**

Blood vessels are a network of branched tubes that transport blood. There are three types of blood vessels namely **arteries, veins and capillaries**

**Arteries:** They are **thick and elastic vessels** that carry blood away from the heart to various organs of the body. All arteries carry oxygenated blood except the pulmonary artery which carry deoxygenated blood to the lungs.

**Veins:** Veins are **thin and non-elastic vessels** that transport blood to the heart from the different organs. All veins carry deoxygenated blood except the pulmonary vein which carry oxygenated blood from the lungs to the heart.

**Capillaries:** Capillaries are narrow tubes formed by branching of arterioles which then unite to form the venules and veins. They are about 8 μm in diameter. Capillaries are formed of single layer of endothelial cells.

**Table 14.1** Differences between Artery and Vein

S.No	Artery	Vein
1	Distributing vessel	Collecting vessel
2	Pink in colour	Red in colour
3	Deep location	Superficial in location
4	Blood flow with high pressure	Blood flow with low pressure
5	Wall of artery is strong, thick and elastic	Wall of vein is weak, thin and non-elastic
6	All arteries carry oxygenated blood except pulmonary arteries	All veins carry deoxygenated blood except pulmonary veins
7	Internal valves are absent	Internal valves are present

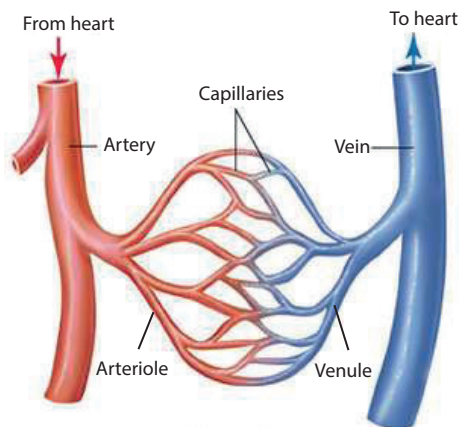

Figure 14.10 Structure of blood vessel

### 14.14 Types of Circulatory System

Animals possess two types of circulatory system. They are

1. Open type
2. Closed type

#### Open type

In open type the blood is pumped by heart into blood vessels that open into blood spaces called as **sinuses**. These sinuses are the body cavities which are called **haemocoel**. Capillary system is absent. e.g. Arthropods, Molluscs and Ascidians.

#### Closed type

In closed type the blood flows in a complete circuit around the body through specific blood vessels. The blood flows from arteries to veins through small blood vessels called capillaries. e.g. Vertebrates.

#### More to Know

Closed circulatory system was discovered by William Harvey (1628) who is regarded the Father of Modern Physiology.

### 14.15 Structure of Human Heart

Heart is a muscular pumping organ that pumps out the blood into the blood vessels. Human heart is situated between the lungs,

slightly tilted toward the left and above the diaphragm in the **thoracic cavity**. The heart is made of specialized type of muscle called the **cardiac muscle**.

The heart is enclosed in a double walled sac called **pericardium**. It contains lubricating **pericardial fluid** which reduces **friction** during heart beat and protects it from mechanical injuries.

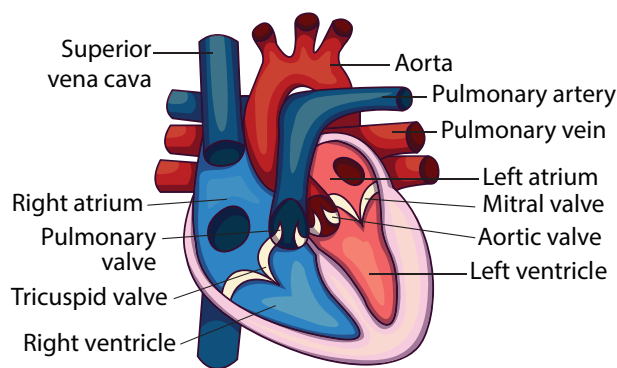

Figure 14.11 External structure of human heart

The human heart is four chambered. The two upper **thin** walled chambers of the heart are called auricle or **atria** (sing: atrium) and two lower **thick** walled chambers are called **ventricles**. The chambers are separated by partition called **septum**. The septum between auricles and ventricles prevents the mixing of oxygenated and deoxygenated blood.

The two auricles are separated from each other by **interatrial septum**. The left atrium is smaller than the right atrium. The right atrium receives deoxygenated blood from different parts of the body through the main veins **superior vena cava**, **inferior vena cava** and **coronary sinus**. **Pulmonary veins** bring **oxygenated blood** to the left atrium from the lungs. The right and left auricles pump blood into the right and left ventricles respectively.

The ventricles form the lower part of the heart. The two ventricles are separated from each other by an **interventricular septum**. The left and right ventricles have **thick walls** because the ventricles have to pump out blood with force away from the heart. From the **right ventricle**

arises the **pulmonary trunk** which bifurcates to form right and left pulmonary arteries. The right and left pulmonary arteries supply **deoxygenated blood** to the lungs of the respective side. The left ventricle is longer and narrower than the right ventricle. The walls are about three times thicker than the right ventricle. The **left ventricle** gives rise to **aorta**. The **oxygenated blood** is supplied by the aorta to various organs of the body. The **coronary arteries** supply blood to the heart.

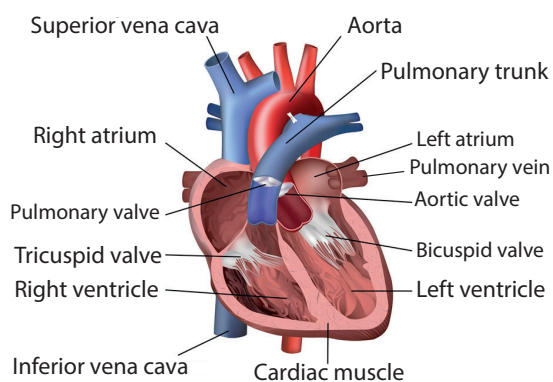

Figure. 14.12 Internal structure of human heart

**Valves:** The valves are the muscular flaps that regulate the flow of blood in a single direction and prevent back flow of blood. The heart contains three types of valves.

**Right atrioventricular valve:** It is located between the right auricle and right ventricle. It has three thin triangular leaf like flaps and therefore called **tricuspid valve**. The apices of the flaps are held in position by **chordae tendinae** arising from the muscular projection of the ventricle wall known as **papillary muscles**.

**Left atrioventricular valve:** It is located between the left auricle and left ventricle. It has two cusps and therefore called **bicuspid** or **mitral valve**.

**More to Know**

**Heart chambers in vertebrate animals**

**Two chambered:** Fishes

**Three chambered:** Amphibians

**Incomplete four chambered:** Reptiles

**Four chambered:** Aves, Mammals and Crocodiles (Reptile)

**Semilunar valves:** The major arteries (pulmonary artery and aorta) which leave the heart have semilunar valves which prevent backward flow of blood into the ventricles. They are the pulmonary and aortic semilunar valves.

**14.15.1 Types of Blood Circulation**

The blood circulates in our body as oxygenated and deoxygenated blood. The types of circulation are:



**i Systemic circulation:** Circulation of oxygenated blood from the left ventricle of the heart to various organs of the body and return of deoxygenated blood to the right atrium. Aorta carries oxygenated blood to all the organs of the body.

**ii Pulmonary circulation:** The path of pulmonary circulation starts in the right ventricle. Pulmonary artery arises from the right ventricle and reaches the lungs with deoxygenated blood. Pulmonary veins collect the oxygenated blood from the lungs and supplies it to the left atrium of the heart.

**iii Coronary circulation:** The supply of blood to the heart muscles (cardiac muscles) is called as **coronary circulation**. Cardiac muscles receive oxygenated blood from **coronary arteries** that originate from the **aortic arch**. Deoxygenated blood from the cardiac muscles drains into the right atrium by the **coronary sinuses**.

When the blood circulates twice through the heart in one complete cycle it is called **double circulation**. In double circulation the oxygenated blood do not mix with the deoxygenated blood.

However, in some animals the oxygenated and deoxygenated blood are mixed and pass through the heart only once. This type of circulation is called **single circulation**. e.g., fishes, amphibians and certain reptiles.



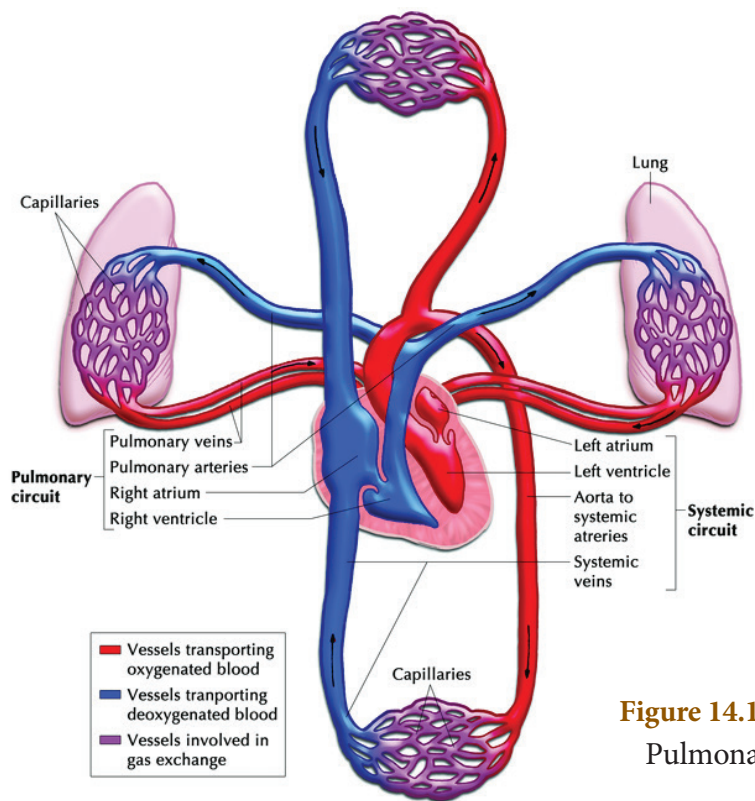

Figure 14.13 Systemic and Pulmonary circulation

### 14.15.2 Heart Beat

One complete **contraction** (systole) and **relaxation** (diastole) of the atrium and ventricles of the heart constitute heartbeat. The heart normally beats 72 – 75 times per minute.

#### More to Know

##### Neurogenic and Myogenic Heart Beat

Neurogenic heart beat is initiated by a nerve impulse caused from a nerve ganglion situated near the heart. e.g. Annelids, most arthropods

Myogenic heart beat is initiated by a specialized group of modified heart muscle fibres. e.g. Mollusca and Vertebrates

#### Initiation and conduction of Heart beat

The human heart is **myogenic** in nature. Contraction is initiated by a specialized portion of the heart muscle, the **sino-atrial (SA) node** which is situated in the wall of the right atrium near the opening of the **superior vena cava**. The SA node is broader at the top and tapering below. It is made up of thin fibres.

**Sino-atrial node** acts as the ‘**pacemaker**’ of the heart because it is capable of initiating impulse which can stimulate the heart muscles to contract. The impulse from the sinoatrial node spreads as a wave of contraction over the right and left atrial wall pushing the blood through the **atrioventricular** valves into the ventricles. The wave of contraction from SA node reaches the **atrioventricular (AV) node** which is stimulated to emit an impulse of contraction spreading to the ventricular muscle via the **atrioventricular bundle** and the **Purkinje fibres**.



Atrioventricular bundle was discovered by His (1893). So is called Bundle of His.

**Pulse:** When the heart beats the blood is forced into the arteries. The expansion of the artery every time the blood is forced into it is called pulse. It can be felt by placing the fingertip on the artery near the wrist. Normal pulse rate ranges from 70 – 90 / min.

**Activity 3**

**Determining Heart Rate**

**Materials :**

Stop watch or Stop clock.

**Procedure:**

1. Have your partner to find the pulse in your wrist and count your heartbeats for 15 seconds while you are seated. Calculate your resting heart rate in beats per minute.
2. Have your partner to count your heart beats for 15 seconds after you jog or run for 5 minutes. Calculate your heart rate in beats per minute.

**Analyse:**

- What causes your pulse ?
- What causes the change in your heart beat rate in each situation ?

**14.15.3 Cardiac Cycle**

The sequence of events occurring from the **beginning** to the **completion of one heart beat** is called cardiac cycle. During cardiac cycle blood flows through the chambers of the heart in a specific direction. Each cardiac cycle lasts about **0.8 second**. The events during a single cardiac cycle involves

- (a) **Atrial systole:** Contraction of auricles (0.1 sec)
- (b) **Ventricular systole:** Contraction of ventricles (0.3 sec)
- (c) **Ventricular diastole:** Relaxation of ventricles (0.4 sec)

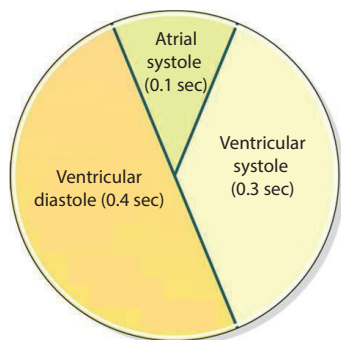

**14.15.4 Heart Sound**

The rhythmic closure and opening of the valves cause the sound of the heart.

The **first sound LUBB** is of longer duration and is produced by the closure of the tricuspid and bicuspid valves after the beginning of ventricular systole. The **second sound DUPP** is of a shorter duration and produced by the closure of semilunar valves at the end of ventricular systole.

**14.16 Blood pressure**

Blood pressure is the **force exerted** during the flow of blood against the **lateral walls of arteries**. The blood pressure is high in the arteries gradually drops in the arterioles and capillaries and become very low in the veins.

Blood pressure is usually expressed in terms of the systolic pressure and diastolic pressure.

**Systolic pressure:** During ventricular systole, the left ventricle contracts and forces blood into the aorta. The pressure rises to a peak which is referred as systolic pressure.

**Diastolic pressure:** During diastole, the ventricles relax and the pressure falls to the lowest value which is referred as diastolic pressure.

In an healthy adult during normal resting condition systolic and diastolic blood pressure is expressed as **120mm / 80mm Hg**. Blood pressure varies during conditions of physical exercise, anxiety, emotions, stress and sleep.

A prolonged or constant elevation of blood pressure is a condition known as **hypertension (High blood pressure)** can increase the risk of heart attack and stroke. Decrease in blood pressure is termed hypotension (**Low blood pressure**).

**Stethoscope**

A stethoscope is used to detect the sound produced by the internal organs of human body. The heart sound is heard by placing the

stethoscope on the chest. It is a useful diagnostic tool to identify and localize health problems and diagnose disease. The modern electronic stethoscopes are high precision instruments.



Figure 14.14 Stethoscope

### Sphygmomanometer

Sphygmomanometer is a clinical instrument used to measure blood pressure when a person is in a relaxed and resting condition. The pressure of the brachial artery is measured. It helps to estimate the state of blood circulation and the working of the heart. It helps to diagnose conditions such as increased or decreased blood pressure. **Monometric** and **modern digital** types are the apparatus used to measure blood pressure.

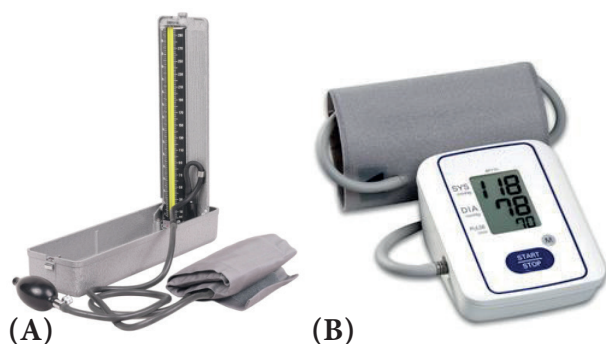

Figure 14.15 Monometric (A) and Digital (B) type blood pressure apparatus

### 14.17 Blood Groups

The concept of blood grouping was developed by **Karl Landsteiner** (1900). He identified blood groups **A**, **B** and **O**. **AB** blood group was recognized by **Decastello** and **Steini** (1902).

Human blood contains certain specific substances called **agglutinogens** or **antigens (Ag)** and **agglutinins** or **antibodies (Ab)**. Antigens are found on the membrane surface of **RBC**. Antibodies are present in blood plasma. Based on the presence or absence of antigen and antibodies human blood group is classified into four groups called **A**, **B**, **AB** and **O**. An individual has one of the four blood groups.

- (i) 'A' group individuals: **Antigen A** is present on the surface of RBC and **antibody b (anti-b)** is present in the plasma.
- (ii) 'B' group individuals: **Antigen B** is present on the surface of RBC and **antibody a (anti - a)** is present in the plasma.
- (iii) 'AB' group individuals: **Antigens A and B** are present on the surface of RBC and both the **antibodies are absent** in the plasma.
- (iv) 'O' group individuals: **Antigen A or B** are absent on the surface of RBC. However, the plasma **contains both the antibodies a and b (anti a and b)**.

### Blood donation

In blood transfusion one must consider the antigen and antibody compatibility (matching) between the donor and the person receiving blood (recipient). When an individual receives a mismatched blood group from the donor **agglutination (clumping)** of blood occurs in the body which leads to death.

Persons with 'AB' blood group are called '**Universal Recipient**' as they can **receive blood** from persons with any blood group.

Persons with 'O' blood group are called '**Universal Donor**' as they can **donate blood** to persons with any blood group.

### Rh factor

Rh factor was discovered by **Landsteiner** and **Wiener** in 1940 in **Rhesus monkey**. The surface of RBC contains the antigen for Rh factor. **Rh<sup>+</sup>** (positive) persons have Rh antigen on the surface of RBC while, **Rh<sup>-</sup>** (negative)

**Table 14.2** Distribution of Antigen (RBC) and Antibody (Plasma) in different Blood Groups

Blood Group	Antigens on RBC	Antibodies in Plasma	Can donate to	Can receive from
A	Antigen A	anti- b	A and AB	A and O
B	Antigen B	anti- a	B and AB	B and O
AB	Antigen A and B	No antibody	AB	A, B, AB and O (Universal Recipient)
O	No Antigen	Both anti a and b	A, B, AB and O (Universal Donor)	O

persons do not have Rh antigen on the surface of RBC. Antibodies developed against this Rh antigen is called **Rh antibodies**.

### 14.18 Lymphatic System

The lymphatic system comprises of lymphatic capillaries, lymphatic vessels, lymph nodes and lymphatic ducts. Lymph is the fluid that flows through the lymphatic system.

The **lymphatic capillaries** unite to form large **lymphatic vessels**. **Lymph nodes** are small oval or pear shaped structures located along the length of lymphatic vessels.

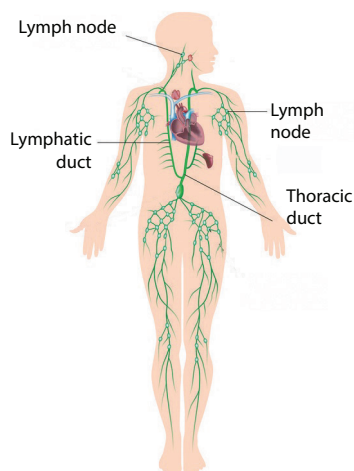

**Figure 14.16** Lymphatic System in Man

#### Lymph

Lymph from the intercellular spaces drains into lymphatic capillaries. Lymph is a colourless fluid formed when plasma, proteins and blood cells escape into intercellular spaces in the tissues through the pores present in the walls of capillaries. It is similar to blood plasma,

but is colourless and contains less proteins. The lymph contains very small amount of nutrients, oxygen, CO<sub>2</sub>, water and WBC.

#### Functions of Lymph

- Supplies nutrients and oxygen to those parts where blood cannot reach
- It drains away excess tissue fluid and metabolites and returns proteins to the blood from tissue spaces.
- The lymph also carries absorbed fats from small intestine to the blood. The lymphatic capillaries of intestinal villi (lacteals) absorb digested fats.
- Lymphocytes in the lymph defend the body from infections.

#### Points to Remember

- ❖ The movement of molecules from a region of higher concentration to a region of their lower concentration without the utilization of energy is called diffusion.
- ❖ Osmosis is the movement of solvent or water molecules from the region of higher concentration to the region of lower concentration through a semi-permeable membrane.
- ❖ Transpiration is the evaporation of water in plants through stomata in the leaves.
- ❖ The circulatory system consists of the circulating fluids, the blood and lymph and the heart and its blood vessels.

- ❖ The blood consists of two main components. The fluid plasma and the formed elements (blood cells) which are found suspended in the plasma.
- ❖ A muscular pumping organ that pumps out the blood into the blood vessels is called heart.
- ❖ The blood circulates in our body as oxygenated and deoxygenated blood.
- ❖ The supply of blood to the heart muscles (cardiac muscles) is called as coronary circulation.
- ❖ One complete contraction (systole) and relaxation (diastole) of atrium and ventricles of heart is called a heartbeat.
- ❖ The sequence of events which occur during the beginning and completion of one heart beat is called cardiac cycle.
- ❖ Blood pressure is usually expressed as systolic pressure and diastolic pressure (120mm / 80 mm Hg)
- ❖ An individual has one of the four blood groups A, B, AB and O.
- ❖ Rh factor was discovered by Landsteiner and Wiener in 1940.
- ❖ Lymph is a colourless fluid formed when plasma, proteins and blood cells escape into intercellular spaces in the tissues through the pores present in the walls of capillaries.



## TEXTBOOK EVALUATION



### I. Choose the correct answer

1. Active transport involves
  - a) movement of molecules from lower to higher concentration
  - b) expenditure of energy
  - c) it is an uphill task
  - d) all of the above
2. Water which is absorbed by roots is transported to aerial parts of the plant through
 

a) cortex	b) epidermis
c) phloem	d) xylem
3. During transpiration there is loss of
 

a) carbon dioxide	b) oxygen
c) water	d) none of the above
4. Root hairs are
 

a) cortical cell	b) projection of epidermal cell
c) unicellular	d) both b and c
5. Which of the following process requires energy?
 

a) active transport	b) diffusion
c) osmosis	d) all of them
6. The wall of human heart is made of
 

a) Endocardium	b) Epicardium
c) Myocardium	d) All of the above
7. Which is the correct sequence of blood flow
  - a) ventricle → atrium → vein → arteries
  - b) atrium → ventricle → veins → arteries
  - c) atrium → ventricle → arteries → vein
  - d) ventricles → vein → atrium → arteries
8. A patient with blood group **O** was injured in an accident and has blood loss. Which group of blood should be used by doctor for transfusion?
 

a) O group	b) AB group
c) A or B group	d) all blood group

9. 'Heart of heart' is called
- a) SA node                      b) AV node  
c) Purkinje fibres              d) Bundle of His
10. Which one of the following shows correct composition of blood
- a) Plasma - Blood + Lymphocyte  
b) Serum - Blood + Fibrinogen  
c) Lymph - Plasma + RBC + WBC  
d) Blood - Plasma + RBC + WBC + Platelets

**II. Fill in the blanks**

- \_\_\_\_\_ involves evaporative loss of water from aerial parts.
- Water enters into the root hair cell through \_\_\_\_\_ membrane.
- Part of the root that absorbs water from the soil is \_\_\_\_\_.
- Normal blood pressure is \_\_\_\_\_.
- The normal human heartbeat rate is about \_\_\_\_\_ time per minute.

**III. Match the following**

**Section I**

- Symplastic pathway - Leaf
- Transpiration - Plasmodesmata
- Osmosis - Pressure in xylem
- Root Pressure - Pressure gradient

**Section II**

- Leukemia - Thrombocytes
- Platelets - Phagocyte
- Monocytes - Decrease in leucocytes
- Leucopenia - Blood Cancer
- AB blood group - Allergic condition
- O blood group - Inflammation
- Eosinophil - Absence of antigen
- Neutrophils - Absence of antibody

**IV. State whether True or False. If false write the correct statement**

- The phloem is responsible for the translocation of food.
- Plants lose water by the process of transpiration.
- The form of sugar transported through the phloem is glucose.
- In apoplastic movement the water travels through the cell membrane and enter the cell.
- When guard cells lose water the stoma opens.
- Initiation and stimulation of heart beat take place by nerves.
- All veins carry deoxygenated blood.
- WBC defend the body from bacterial and viral infections.
- The closure of the mitral and tricuspid valves at the start of the ventricular systole produces the first sound 'LUBB'.

**V. Answer in a word or sentence**

- Name two layered protective covering of human heart.
- What is the shape of RBC in human blood?
- Why is the colour of the blood red ?
- Which kind of cells are found in the lymph?
- Name the heart valve associated with the major arteries leaving the ventricles.
- Mention the artery which supplies blood to the heart muscle.

**VI. Short answer questions**

- What causes the opening and closing of guard cells of stomata during transpiration?
- What is cohesion?
- Trace the pathway followed by water molecules from the time it enters a plant root to the time it escapes into the atmosphere from a leaf.

4. What would happen to the leaves of a plant that transpires more water than its absorption in the roots?
5. Describe the structure and working of the human heart.
6. Why is the circulation in man referred to as double circulation?
7. What are heart sounds? How are they produced?
8. What is the importance of valves in the heart?
9. Who discovered Rh factor? Why was it named so?
10. How are arteries and veins structurally different from one another?
11. Why is the Sinoatrial node called the pacemaker of heart?
12. Differentiate between systemic circulation and pulmonary circulation.
13. The complete events of cardiac cycle last for 0.8 sec. What is the timing for each event?

**VII. Give reasons for the following statements**

1. Minerals cannot be passively absorbed by the roots.
2. Guard cells are responsible for opening and closing of stomata.
3. The movement of substances in the phloem can be in any direction.
4. Minerals in the plants are not lost when the leaf falls.
5. The walls of the right ventricle are thicker than the right auricles.
6. Mature RBC in mammals do not have cell organelles.

**VIII. Long answer questions**

1. How do plants absorb water? Explain.
2. What is transpiration? Give the importance of transpiration.

3. Why are leucocytes classified as granulocytes and agranulocytes? Name each cell and mention its functions.
4. Differentiate between systole and diastole. Explain the conduction of heart beat.
5. Enumerate the functions of blood.

**IX. Assertion and Reasoning**

**Direction:** In each of the following questions a statement of assertion (A) is given and a corresponding statement of reason (R) is given just below it. Mark the correct statement as.

- a. If both A and R are true and R is correct explanation of A
  - b. If both A and R are true but R is not the correct explanation of A
  - c. A is true but R is false
  - d. Both A and R are false
1. **Assertion:** RBC plays an important role in the transport of respiratory gases.  
**Reason:** RBC do not have cell organelles and nucleus.
  2. **Assertion:** Persons with AB blood group are called an universal recipients, because they can receive blood from all groups.  
**Reason:** Antibodies are absent in persons with AB blood group.

**X. Higher Order Thinking Skills (HOTS)**

1. When any dry plant material is kept in water, they swell up. Name and define the phenomenon involved in this change.
2. Why are the walls of the left ventricle thicker than the other chambers of the heart?
3. Doctors use stethoscope to hear the sound of the heart. Why?
4. How does the pulmonary artery and pulmonary vein differ in their function when compared to a normal artery and vein?
5. Transpiration is a necessary evil in plants. Explain.



**REFERENCE BOOKS**

1. V.K.Jain, Fundamentals of Plant physiology, S.Chand and Company, New Delhi
2. D.G Maclean and Dave Hayward, Biology Cambridge IGCSE
3. S.C.Rastogi., Essential of Animal Physiology, 4<sup>th</sup> Edition, New Age International Publishers

4. Elain N. Marieb and Katja Hoehn, 2011, Anatomy and Physiology, 4<sup>th</sup> Edition, Pearson Publications.



**INTERNET RESOURCES**

- <http://www.britannica.com/science/human-circulatory-system>
- <http://biologydictionary.net/circulatory-system/>

**Concept Map**

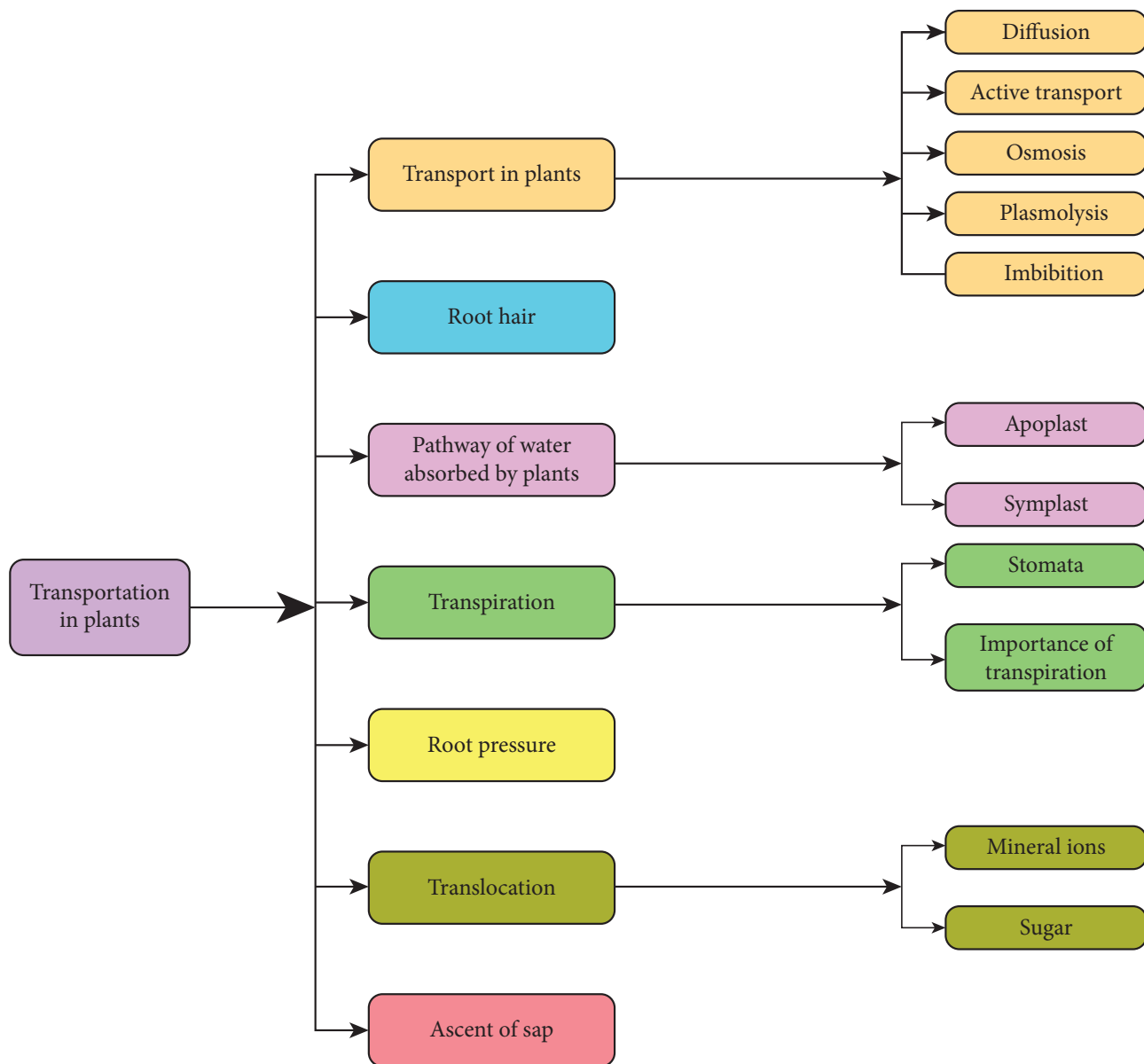



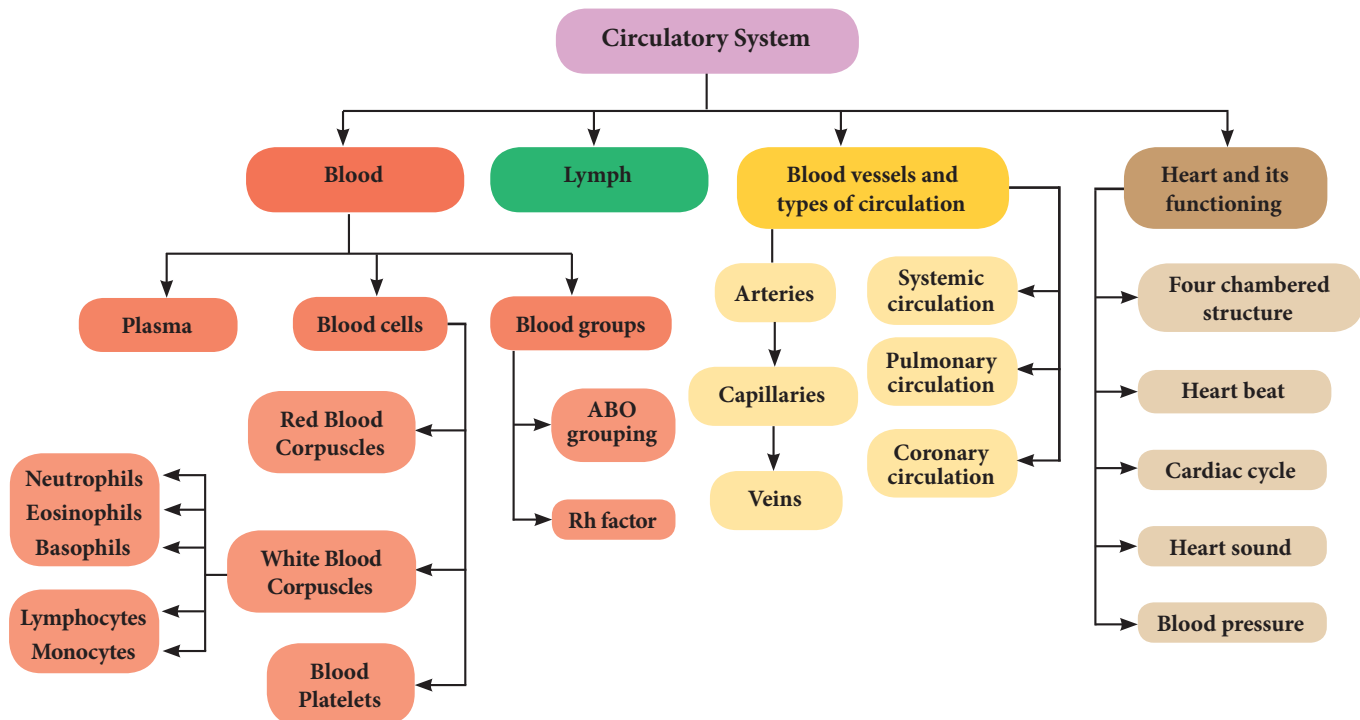

## ICT CORNER

## CIRCULATION IN ANIMALS

**CHE-cardiovascular system- This 3D application enables the student to know about the structure and functions of cardio vascular system.**

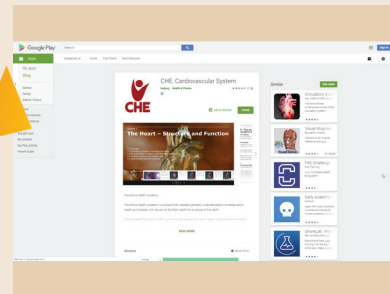

### Steps

- Access the application CHE – cardiovascular system with the help of URL or QR code given below. After installing it in your device, when you open the app, you can see 4 sections as Introduction, Heart – structure & functions, Blood circulatory system and Blood.
- In each section, description as well as supportive images will be given.
- If you click the picture, a video will be played in it. You can zoom in and zoom out the images and also you can see its any direction by making movements.
- We can maximize as well as minimize the speed of the 3D animation to get clear details of it.



Step1



Step2

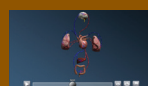

Step3



Step4

### Cells alive

URL : <https://play.google.com/store/apps/details?id=com.bodyxq.appbookCardio>

\*Pictures are indicative only



B375\_10\_SCIENCE\_EM

 UNIT  
15

 NERVOUS SYSTEM

## Learning Objectives

At the end of the lesson the students will be able to :

- ◆ Admire nervous system as the control and coordinating centre of the body.
- ◆ Learn the components of the nervous system.
- ◆ Analyse the transmission of nerve impulses.
- ◆ Understand the divisions of human nervous system.
- ◆ Interpret the different sections of brain which handle different functions.
- ◆ Know the significance of reflex action and its operative pathway.



MJ83H8

## Introduction

One of the characteristic features of all living organisms is responding to stimuli. 'Stimulus' refers to the changes in the environmental condition, that are detected by receptors present in the body. Relevant changes in the activities of organisms to a particular stimuli are called their **reactions** or **responses**. Living organisms show their response to different kinds of stimuli like light, heat, cold, sound, smell, taste, touch, pressure, pain or the force of gravity etc. For example, withdrawal of hand when we touch hot objects or closing the eyes when flashed with bright light, in this condition heat or light is the stimulus to which the body shows its response. Thus, on receiving a stimulus, the body responds in a manner that is most appropriate for its survival and functioning.

To provide the correct response to a stimulus, it is necessary that all the organs work together in a proper coordinated manner. This working together of various organs in a systematic, controlled and efficient way to produce proper response to various stimuli is called **coordination**. In animals including human the coordination between the various cells and organs is essential for their diverse activities to maintain physiological balance called **homeostasis**. In this unit we shall learn about one of the major regulatory systems the nervous system and its control over the body activities.

### 15.1 Nervous System

The nervous system is made up of nervous tissues. It is formed of three distinct components namely the neurons, neuroglia and nerve fibres.

- (i) **Neuron or nerve cell:** A neuron or nerve cell is the structural and functional unit of the nervous system. It is the longest cell of the human body with a length of over 100µm. These cells are highly specialised to detect, receive and transmit different kinds of stimuli. Information is conducted through neurons in the form of electrical impulses from one part of the body to another.
- (ii) **Neuroglia:** Neuroglia are also called as **glial cells**. They are non-exciting, supporting cell of the nervous system. They do not initiate or conduct nerve impulses.
- (iii) **Nerve fibres:** The nerve fibres are the long slender processes of neurons. A number of nerve fibres are bundled up together to form **nerves**.

### 15.1.1 Structure of Neuron

A neuron typically consists of three basic parts: Cyton, Dendrites and Axon.

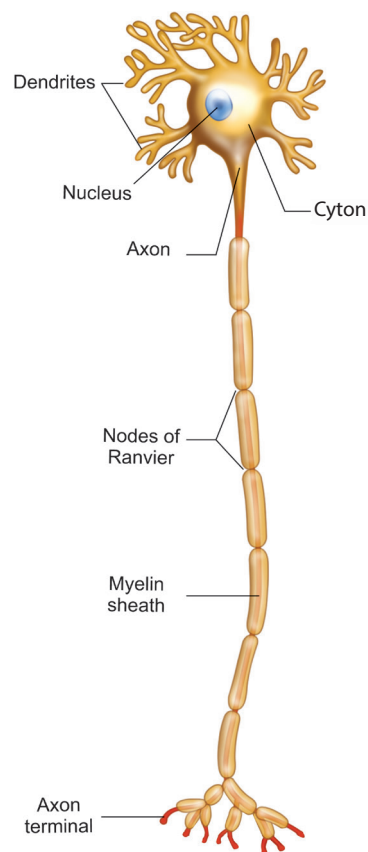

Fig. 15.1 Structure of Neuron

- (i) **Cyton:** Cyton is also called cell body or perikaryon. It has a central nucleus with abundant cytoplasm called **neuropasm**. The cytoplasm has large granular body called **Nissl's granules** and the other cell organelles like mitochondria, ribosomes, lysosomes, and endoplasmic reticulum. Neurons do not have the ability to divide. Several neurofibrils are present in the cytoplasm that help in transmission of nerve impulses to and from the cell body.
  - (ii) **Dendrites:** These are the numerous branched cytoplasmic processes that project from the surface of the cell body. They conduct nerve impulses towards the cyton. The branched projections increase the surface area for receiving the signals from other nerve cells.
  - (iii) **Axon:** The axon is a single, elongated, slender projection. The end of axon terminates as fine branches which terminate into knob like swellings called **synaptic knob**. The plasma membrane of axon is called **axolemma**, while the cytoplasm is called **axoplasm**. It carries impulses away from the cyton. The axons may be covered by a protective sheath called **myelin sheath** which is further covered by a layer of **Schwann cells** called **neurilemma**. Myelin sheath breaks at intervals by depressions called **Nodes of Ranvier**. The region between the nodes is called as **internode**. Myelin sheath acts as insulator and ensures rapid transmission of nerve impulses.
- Synapse:** A junction between synaptic knob of axon of one neuron and dendron of next neuron is called **synaptic junction**. Information from one neuron can pass to another neuron through these junctions with the release of chemicals known as neurotransmitters from the synaptic knob.

**Activity 1**

Create a model of a neuron using clay or beads.

**15.1.2 Types of Neurons**

The neurons may be of different types based on their structure and functions.

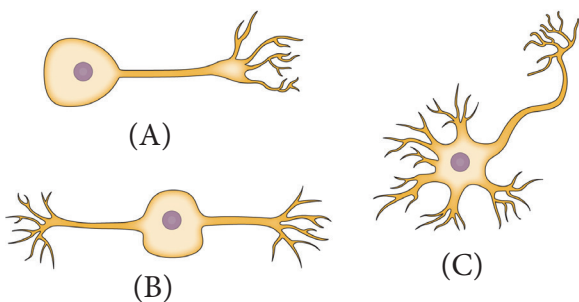

**Fig. 15.2** Unipolar (A), Bipolar (B) and multipolar (C) neurons

Structurally the neurons may be of the following types:

- (i) **Unipolar neurons:** Only one nerve process arises from the cyton which acts as both axon and dendron.
- (ii) **Bipolar neurons:** The cyton gives rise to two nerve processes of which one acts as an axon while another as a dendron.
- (iii) **Multipolar neurons:** The cyton gives rise to many dendrons and an axon

<b>Unipolar Neurons</b>	Found in early embryos but not in adult
<b>Bipolar Neurons</b>	Found in retina of eye and olfactory epithelium of nasal chambers
<b>Multipolar Neurons</b>	Found in cerebral cortex of brain

On the basis of functions neurons are categorised as:-

- (i) **Sensory or afferent neurons** which carry impulses from the sense organ to the central nervous system.
- (ii) **Motor or efferent neurons** which carry impulses from the central nervous system to effector organ such as the muscle fibre or the gland.
- (iii) **Association neurons** conduct impulses between sensory and motor neurons.

**15.1.3 Types of Nerve Fibres**

Nerve fibres are of two types based on the presence or absence of myelin sheath.

- (i) **Myelinated nerve fibre:** The axon is covered with myelin sheath
- (ii) **Non-myelinated nerve fibre:** The axon is not covered by myelin sheath.

Myelinated and non-myelinated nerve fibres form the white matter and grey matter of the brain.

**15.2 Transmission of Nerve Impulse**

All the information from the environment are detected by the receptors located in our sense organs such as the eyes, the nose, the skin etc. Information from the receptors is transmitted as **electrical impulse** and is received by the dendritic tips of the neuron. This impulse travels from the dendrite to the cell body and then along the axon to its terminal end. On reaching the axonal end, it causes the nerve endings to release a chemical (**neurotransmitter**) which diffuses across a synapse and starts a similar electrical impulse in the dendrites of the next neuron, then to their cell body to be carried along the axon.

In this way, the electrical signal reaches the brain or spinal cord. The response from brain (or spinal cord) is similarly passed on to the effector organs such as the muscle or gland cell, that undergoes the desired response.

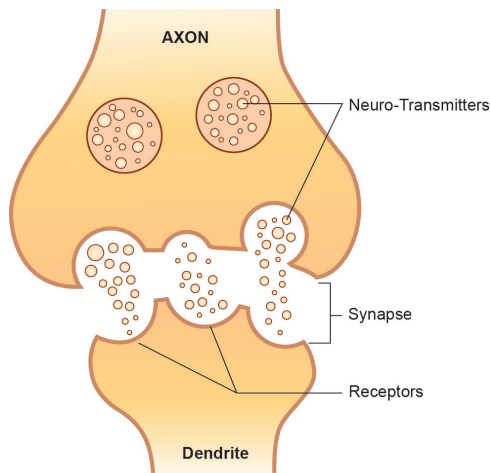

Fig. 15.3 Nerve impulse transmission

The flow of nerve impulses from axonal end of one neuron to dendrite of another neuron through a **synapse** is called **synaptic transmission**.

**DO YOU KNOW?** Each neuron can transmit 1,000 nerve impulses per second and make as many as ten thousands of synaptic contacts with other neurons.

### 15.2.1 Neurotransmitters

Neurotransmitters are the chemicals which allow the transmission of nerve impulse from the axon terminal of one neuron to the dendron of another neuron or to an **effector organ**. The important neurotransmitter released by neurons is called **Acetylcholine**.

## 15.3 Human Nervous System

The complexity of nervous system can be observed during the course of evolution. We the human beings differ from other animals in our ability to think and take actions, which is due to the well developed nervous system. Human nervous system is differentiated into **central nervous system (CNS)**, **peripheral nervous system (PNS)** and **autonomic nervous system (ANS)**.

The CNS acts as centre for information processing and control. It consists of the brain and the spinal cord. The PNS is made up of the nerves which connect the brain and spinal cord to all parts of the body. The ANS is formed of sympathetic and parasympathetic nerves.

### 15.3.1 Central Nervous System

The brain and the spinal cord being delicate vital structures are well protected in bony cavities of the skull and the vertebral column respectively. CNS is formed of two types of matter such as white matter or grey matter with respect to the presence or absence of myelin sheath which we have discussed earlier.

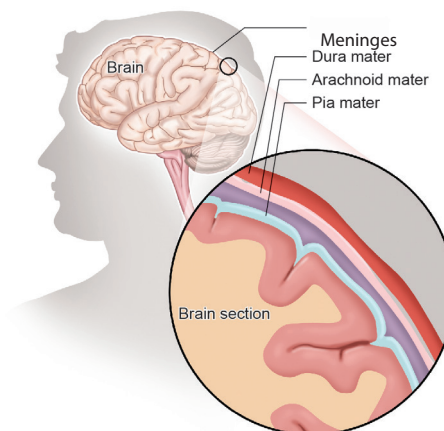

Fig. 15.4 Meninges of Brain

The brain is the controlling centre of all the body activities. It is covered by three connective tissue membrane or **meninges** :

- (i) **Duramater** (*dura*: tough; *mater*: membrane) is the outermost thick fibrous membrane
- (ii) **Arachnoid membrane** (*arachnoid*: spider) is the middle, thin vascular membrane providing web like cushion
- (iii) **Piamater** (*Pia*: soft or tender) is the innermost, thin delicate membrane richly supplied with blood.

Meningeal membranes protect the brain from mechanical injury.



Meningitis is an inflammation of the meninges. It can occur when fluid surrounding the meninges becomes infected. The most common causes of meningitis are viral and bacterial infections.

A human brain is formed of three main parts: (a) forebrain (b) midbrain and (c) hindbrain.

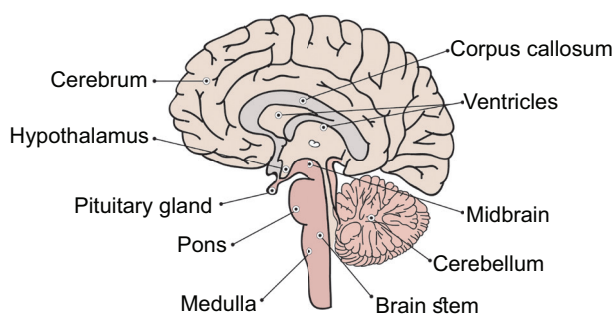

Fig. 15.5 L.S of Human Brain

**Forebrain:** The forebrain is formed of **cerebrum** and **diencephalon**. The latter consists of dorsal *thalamus* and ventral *hypothalamus*.

**Cerebrum**

It is the largest portion forming nearly two-third of the brain. The cerebrum is longitudinally divided into two halves as right and left **cerebral hemispheres** by a deep cleft called **median cleft**. Two cerebral hemispheres are interconnected by thick band of nerve fibres called **corpus callosum**. The outer portion of each cerebral hemisphere is formed of grey matter and is called **cerebral cortex**. The inner or deeper part is formed of white matter and is called **cerebral medulla**. The cortex is extremely folded forming elevations called **gyri** with depressions between them termed as **sulci** that increase its surface area.

Each cerebral hemisphere is divisible into a frontal lobe, a parietal lobe, a temporal lobe and an occipital lobe. These lobes are also known as **cerebral lobes** and are associated with specific functions. Any damage in specific lobe inturn affects its function.

The cerebrum is responsible for the thinking, intelligence, consciousness, memory, imagination, reasoning and willpower.

**Thalamus**

Thalamus present in cerebral medulla is a major conducting centre for sensory and motor signalling. It acts as a **relay centre**.

**Hypothalamus**

It lies at the base of the thalamus. It controls involuntary functions like hunger, thirst, sleep, sweating, sexual desire, anger, fear, water balance, blood pressure etc. It acts as a **thermoregulatory** (temperature control) **center** of the body. It controls the secretion of hormones from anterior pituitary gland and is an important link between nervous system and endocrine system.

**Midbrain**

It is located between thalamus and hind brain. The dorsal portion of the mid brain consists of four rounded bodies called **corpora quadrigemina** that control visual and auditory (hearing) reflexes.

**Hindbrain**

It is formed of three parts **cerebellum**, **pons** and **medulla oblongata**.



The human brain constitutes nearly 60 percent of fat. The most crucial molecules that determine our brain's integrity and the ability are Essential Fatty Acids (EFAs). EFAs cannot be synthesised and must be obtained from food. Fish, green leafy vegetables, almond, walnut are rich sources of EFAs.

### Cerebellum

It is second largest part of the brain formed of two large sized hemispheres and middle vermis. It coordinates voluntary movements and also maintains body balance.

### Pons

'Pons' a latin word meaning bridge. It is a bridge of nerve fibre that connects the lobes of cerebellum. It relay signals between the cerebellum, spinal cord, midbrain and cerebrum. It controls respiration and sleep cycle.

### Medulla Oblongata

Medulla oblongata is the posterior most part of the brain that connects spinal cord and various parts of brain. It has cardiac centres, respiratory centres, vasomotor centres to control heart beat, respiration and contractions of blood vessels respectively. It also regulates vomiting and salivation.

Table 15.1 Overview of brain functions

Structure	Functions
Cerebral cortex	Sensory preception, control of vountary functions, language, thinking, memory, decision making, creativity
Thalamus	Acts as relay station
Hypothalamus	Temperature control, thirst, hunger, urination, important link between nervous system and endocrine glands
Cerebellum	Maintenance of posture and balance,coordinate voluntary muscle activity
Pons and medulla	Role in sleep-awake cycle, cardiovascular, respiratory and digestive control centers

### More to Know

Electroencephalogram (EEG) is an instrument which records the electrical impulses of brain. An EEG can detect abnormalities in the brain waves and help in diagnoses of seizures, epilepsy, brain tumors, head injuries,etc.

### Spinal Cord

Spinal cord is a cylindrical structure lying in the neural canal of the vertebral column. It is also covered by meninges. It extends from the lower end of medulla oblongata to the first lumbar vertebra. The posterior most region of spinal cord tapers into a thin fibrous thread like structure called **filum terminale**.

Internally, the spinal cord contains a cerebrospinal fluid filled cavity known as the **central canal**. The grey matter of spinal cord is 'H' shaped. The upper end of letter 'H' forms **posterior horns** and lower end forms **anterior horns**. A bundle of fibres pass into the posterior horn forming **dorsal** or **afferent root**. Fibres pass outward from the anterior horn forming **ventral** or **efferent root**. These two roots joins to form **spinal nerves**. The white matter is external and have bundle of nerve tracts. Spinal cord conducts sensory and motor impulses to and from the brain. It controls reflex actions of the body.

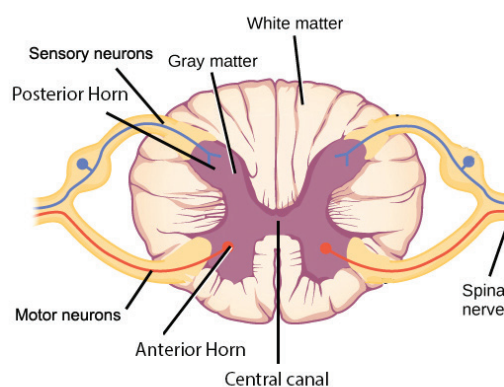

Fig. 15.6 Structure of spinal cord

### 15.4 Cerebrospinal Fluid

The brain is suspended in a special fluid environment called **cerebrospinal fluid** (CSF). It is lymph like, watery fluid that surrounds and protects the brain within the skull. It also fills the central canal of the spinal cord.

**Functions:**

- (i) It acts as shock absorbing fluid and protects the brain from damage when it is subjected to sudden jerk.
- (ii) It supplies nutrients to the brain.
- (iii) It collects and removes wastes from the brain.
- (iv) It is also responsible for maintaining a constant pressure inside the cranium.

### 15.5 Reflex Action

A reflex is any response that occurs automatically without consciousness. There are two types of reflexes.

- (i) **Simple or basic reflexes:** These reflexes are inbuilt and unlearned responses. Many of the actions we perform in our day to day life are simple reflexes. e.g., winking of eyes when any dust particles enters, sneezing, coughing, yawning, etc. We perform these actions without thinking.
- (ii) **Acquired or conditioned reflexes:** These reflexes are the result of practice and learning. Playing harmonium by striking a particular key on seeing a music note is an example of conditioned reflexes which required conscious training effort. Can you think of some more examples of conditioned reflexes?

Most of the reflex actions are monitored and controlled by the spinal cord, hence also known as **spinal reflexes**.

The pathway taken by nerve impulse to accomplish reflex action is called **reflex arc**. Now, let us understand how the body executes reflex action when we touch a hot plate.

- (i) When we touch a very hot pan, the stimulus is the heat which is sensed by receptor called as **heat receptors** or **thermoreceptors** in our hand. This stimulus (heat) inturn triggers an impulse in sensory neuron.

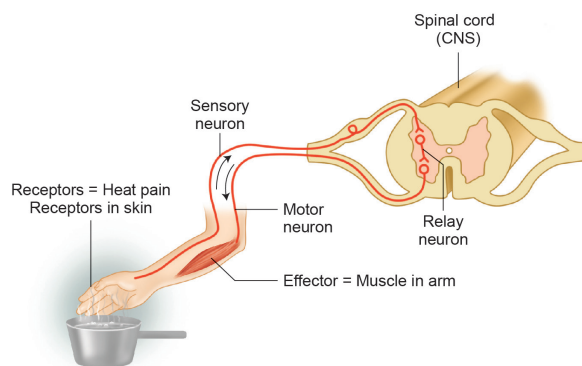

Fig. 15.7 Reflex action and its pathway

- (ii) The **sensory neuron** transmits or conveys the message to the spinal cord.
- (iii) **Spinal cord** interprets the stimulus and the impulse is passed on to the relay neuron which inturn transmits it to a motor neuron.
- (iv) **Motor neurons** carry command from spinal cord to our arm.
- (v) Muscle in our arm contracts and we withdraw our hand immediately from the pan.

In this example, muscle is an effector organ which has responded to the heat. You will study in higher classes how the neuronal impulse triggers the muscular movement.

### 15.6 Peripheral Nervous System

Peripheral nervous system is formed by the nerves arising from the brain and the spinal cord. The nerves arising from the brain



**Activity 2**

You must say the colour of the word but not the name of the word.

BLUE	RED	YELLOW	ORANGE
GREEN	BLUE	PURPLE	RED
PURPLE	YELLOW	RED	BLUE

are called **cranial nerves**. Nerves arising from spinal cord are called **spinal nerves**.

**Cranial Nerves**

In man, there are **12 pairs** of cranial nerves. Some of the cranial nerves are sensory e.g. optic nerve which innervates the eye. Some are motor nerves which helps in rotation of eyeball. It also innervates the eye muscles, muscles of iris and tear gland.

**Spinal Nerves**

There are **31 pairs** of spinal nerves. Each spinal nerve has a dorsal sensory root and the ventral motor root. The direction of impulses in dorsal spinal root is towards the spinal cord and in ventral spinal root away from the spinal cord.

**15.7 Autonomic Nervous System**

Autonomic nervous system (ANS) is also called as visceral nervous system as it regulates the function of internal visceral organs of our body through its two antagonistic (opposite) components **sympathetic** and **parasympathetic systems**. They enable the body to perform rapid and specific visceral activities in order to maintain steady state. It controls the involuntary functions of the visceral organs.

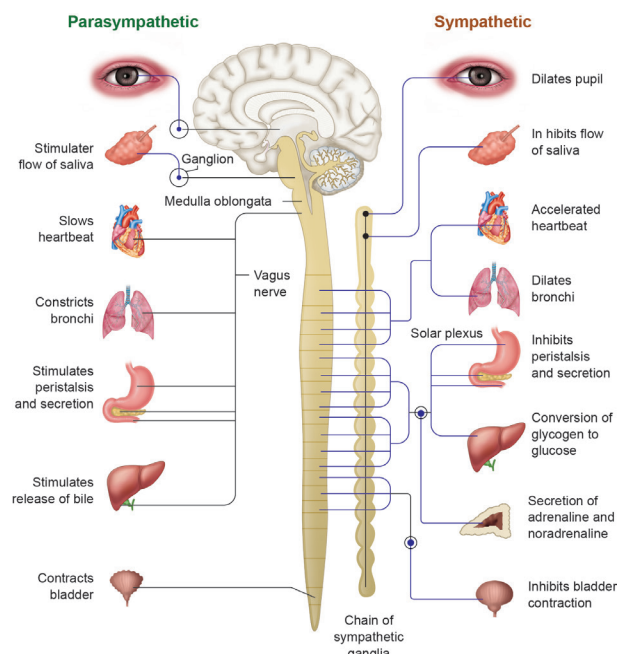

Fig. 15.8 Sympathetic and Parasympathetic nervous system

**Activity 3**

Use the letter and number code to decode the given information

24 18 13 26 8 2 15 24 4 9 4 5 8 25 7  
 19 1 15 21 1 9 8 7 22 2 7 18 23  
 25 1 4 12 10 8 2 13 8 13 5 1 5  
 B Z 19 1 15 21 1 9 8 7 22 8 7 8 24 26  
 1 9 1 15 12 23 24 9 18 7 3 23 12 1 9

A	B	C	D	E	F	G	H	I	J	K	L	M
24	2	21	18	1	22	12	10	4	16	14	26	20
N	O	P	Q	R	S	T	U	V	W	X	Y	Z
9	7	19	6	15	5	8	13	11	25	3	23	0

**Points to Remember**

- ❖ Nervous system controls and coordinates the activities of our body.
- ❖ Neuron is the structural and functional unit of the cell and has three parts- cyton, dendrites and axon.
- ❖ A receptor is a cell or group of cells that receives the stimuli. An effector is a part of the body which can respond to a stimulus

according to the instructions from the brain or the spinal cord.

- ❖ CNS is formed of brain and spinal cord. PNS consists of all nerves which connect brain and spinal cord to all parts of the body. ANS operates automatically and formed of sympathetic and parasympathetic nerves
- ❖ A reflex action is a rapid, automatic response to a stimulus which is not under the voluntary control of the brain.



**TEXTBOOK EVALUATION**



**I. Choose the correct answer**

1. Bipolar neurons are found in  
(a) retina of eye (b) cerebral cortex  
(c) embryo (d) respiratory epithelium
2. Site for processing of vision, hearing, memory, speech, intelligence and thought is  
(a) kidney (b) ear  
(c) brain (d) lungs
3. In reflex action, the reflex arc is formed by  
(a) brain, spinal cord, muscle  
(b) receptor, muscle, spinal cord  
(c) muscle, receptor, brain  
(d) receptor, spinal cord, muscle
4. Dendrites transmit impulse \_\_\_\_\_ cell body and axon transmit impulse \_\_\_\_\_ cell body.  
(a) away from, away from  
(b) towards, away from  
(c) towards,towards  
(d) away from, towards
5. The outer most of the three cranial meninges is  
(a) arachnoid membrane (b) piamater  
(c) duramater (d) myelin sheath
6. There are \_\_\_\_\_ pairs of cranial nerves and \_\_\_\_\_ pairs of spinal nerves.  
(a) 12, 31 (b) 31, 12 (c) 12, 13 (d) 12, 21
7. The neurons which carries impulse from the central nervous system to the muscle fibre.  
(a) afferent neurons (b) association neuron  
(c) efferent neuron (d) unipolar neuron
8. Which nervous band connects the two cerebral hemispheres of brain?  
(a) thalamus (b) hypothalamus  
(c) corpus callosum (d) pons
9. Node of Ranvier is found in  
(a) muscles (b) axons  
(c) dendrites (d) cyton
10. Vomiting centre is located in  
(a) medulla oblongata (b) stomach  
(c) cerebrum (d) hypothalamus
11. Nerve cells do not possess  
(a) neurilemma (b) sarcolemma  
(c) axon (d) dendrites
12. A person who met with an accident lost control of body temperature, water balance, and hunger. Which of the following part of brain is supposed to be damaged?  
(a) Medulla oblongata (b) cerebrum  
(c) pons (d) hypothalamus

**II. Fill in the blanks**

1. \_\_\_\_\_ is the longest cell in our body.
2. Impulses travels rapidly in \_\_\_\_\_ neurons.
3. A change in the environment that causes an animal to react is called \_\_\_\_\_ .
4. \_\_\_\_\_ carries the impulse towards the cell body.
5. The two antagonistic component of autonomic nervous system are \_\_\_\_\_ and \_\_\_\_\_.
6. A neuron contains all cell organelles except \_\_\_\_\_ .
7. \_\_\_\_\_ maintains the constant pressure inside the cranium.
8. \_\_\_\_\_ and \_\_\_\_\_ increases the surface area of cerebrum.
9. The part of human brain which acts as relay center is \_\_\_\_\_ .

**III. State whether true or false, if false write the correct statement**

1. Dendrons are the longest fibres that conducts impulses away from the cell body.
2. Sympathetic nervous system is a part of central nervous system.
3. Hypothalamus is the thermoregulatory centre of human body.
4. Cerebrum controls the voluntary actions of our body.
5. In the central nervous system myelinated fibres form the white matter.
6. All the nerves in the body are covered and protected by meninges.
7. Cerebrospinal fluid provides nutrition to brain.
8. Reflex arc allows the rapid response of the body to a stimulus.
9. Pons helps in regulating respiration.

**IV. Match the following**

Column I	Column II
A. Nissil's granules	Forebrain
B. Hypothalamus	Peripheral Nervous system
C. Cerebellum	Cyton
D. Schwann cell	Hindbrain

**V. Understand the assertion statement. Justify the reason given and choose the correct choice**

- a. Assertion is correct and reason is wrong
  - b. Reason is correct and the assertion is wrong
  - c. Both assertion and reason are correct
  - d. Both assertion and reason are wrong
1. **Assertion:** Cerebrospinal fluid is present throughout the central nervous system.  
**Reason:** Cerebrospinal fluid has no such functions.
  2. **Assertion:** Corpus callosum is present in space between the duramater and piamater.  
**Reason:** It serves to maintain the constant intracranial pressure.

**VI. Short answer questions**

1. Define stimulus.
2. Name the parts of the hind brain.
3. What are the structures involved in the protection of brain?
4. Give an example for conditioned reflexes.
5. Which acts as a link between the nervous system and endocrine system?
6. Define reflex arc.

**VII. Differentiate between**

1. Voluntary and involuntary actions.
2. Medullated and non-medullated nerve fibre.

**VIII. Long answer questions**

1. With a neat labelled diagram explain the structure of a neuron.

2. Illustrate the structure and functions of brain.
3. What will you do if someone pricks your hand with a needle? Elucidate the pathway of response with a neat labelled diagram.
4. Describe the structure of spinal cord.
5. How nerve impulses are transferred from one neuron to next neuron?
6. Classify neurons based on its structure.

- (i) Name the cells L
- (ii) What are M and N?
- (iii) What is the gap O?
- (iv) Name the chemical substance P

**IX. Higher Order Thinking Skills (HOTS)**

1. 'A' is a cylindrical structure that begins from the lower end of medulla and extend downwards. It is enclosed in bony cage 'B' and covered by membranes 'C'. As many as 'D' pairs of nerves arise from the structure 'A'.
  - (i) What is A?
  - (ii) Name (a) bony cage 'B' and (b) membranes 'C'
  - (iii) How much is D?
2. Our body contains a large number of cells 'L' which are the longest cells in the body. L has long and short branch called as 'M' and 'N' respectively. There is a gap 'O' between two 'L' cells, through which nerve impulse transfer by release of chemical substance 'P'.



**REFERENCE BOOKS**

1. Guyton and Hall, 2003, Textbook of Medical Physiology; Harcourt Indian Private Limited.
2. Sherwood. L., 2007, Human Physiology: From cells to systems 6<sup>th</sup> Edition, Indian edition, Thomson Brooks/Cole.
3. Singh, H.D., 2007, Handbook of Basic Human Physiology for Paramedical Students. S. Chand and Company Ltd. New Delhi.



**INTERNET RESOURCES**

1. <http://www.britannica.com/science/nervous-system>
2. <http://www.sumanasine.com/webcontent/animations/neurobiology.html>

**Concept Map**

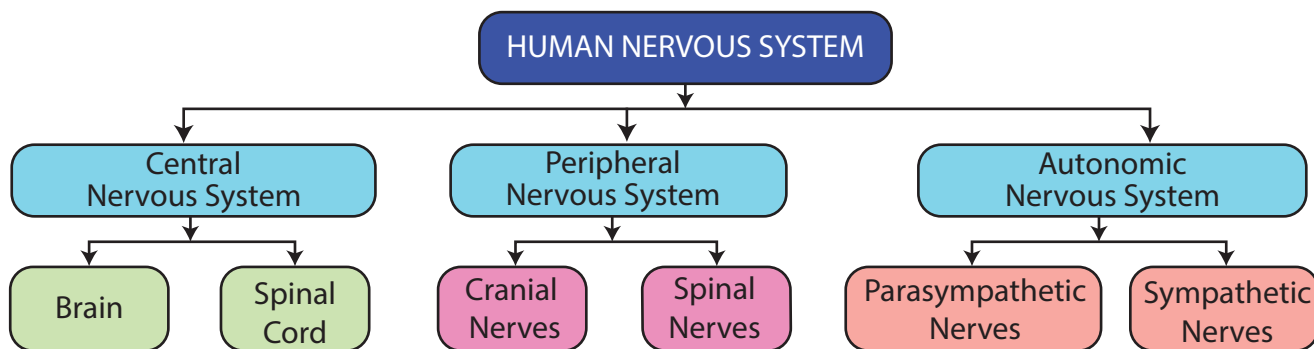



# PLANT AND ANIMAL HORMONES



## Learning Objectives



At the end of this lesson the students will be able to:

- ◆ Define hormone.
- ◆ List out plant hormones.
- ◆ Classify plant hormones into growth promoters and growth inhibitors.
- ◆ Differentiate the physiological effects of various plant hormones.
- ◆ Understand how plant hormones control and coordinate various physiological activities in plants.
- ◆ Know the various endocrine glands in the human body.
- ◆ Identify the location and structure of the endocrine glands in the human body.
- ◆ Differentiate exocrine and endocrine glands.
- ◆ Know the specific site of action and their functions.
- ◆ Identify the disorders which occur due to decreased or increased hormone secretion.

## Introduction

The word hormone is derived from the Greek word “hormon” meaning “to excite”. The function of control and coordination in plants is performed by chemical substances produced by the plants called **plant hormones**. In plants several cells are capable of producing hormones. These phytohormones are transported to different parts of the plants to perform various physiological functions.

**Endocrine glands** in vertebrate animals possess a diversified communication system to co-ordinate physiological and metabolic

functions by **chemical integration**. The endocrine system acts through chemical messengers known as hormones which are produced by specialized glands. Physiological processes such as digestion, metabolism, growth, development and reproduction are controlled by hormones.

## 16.1 Plant Hormones

**Plant hormones** are **organic molecules** that are produced at extremely low concentration in plants. These molecules control morphological, physiological and biochemical responses.

### Types of Plant Hormones

There are five major classes of plant hormones. They are:

1. Auxins
2. Cytokinins
3. Gibberellins
4. Abscisic Acid (ABA)
5. Ethylene



Among all these plant hormones auxins, cytokinins and gibberellins promote plant growth while abscisic acid and ethylene inhibit plant growth.

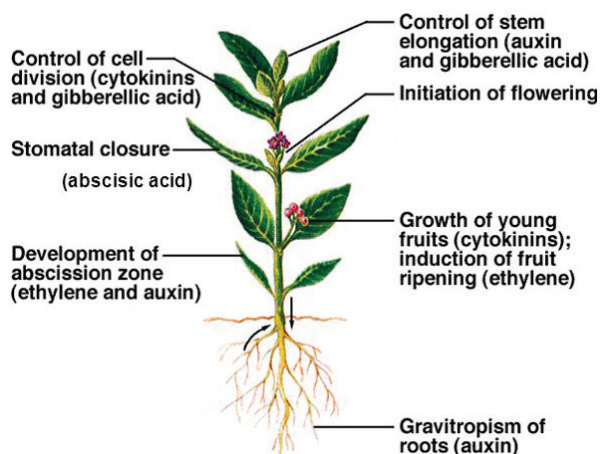

Figure 16.1 Hormonal interaction in plant growth and development

#### 16.1.1.1 Auxins

Auxins (Gk. auxein = to grow) were the first plant hormones discovered. The term auxin was introduced by Kogl and Haagen-Smith (1931). Auxins are **produced at the tip of stems and roots** from where they migrate to the zone of elongation. Charles Darwin (1880), observed unilateral growth and curvature of canary grass (*Phalaris canariensis*) coleoptiles. He came to the conclusion that some ‘influence’ was transmitted from the tip of the coleoptile to the basal region. This ‘influence’ was later identified as Auxin by Went.

##### 16.1.1.1.1 Went’s Experiment

Frits Warmolt Went (1903– 1990), a Dutch biologist demonstrated the existence

and effect of auxin in plants. He did a series of experiments in *Avena* coleoptiles.

In his first experiment he removed the tips of *Avena* coleoptiles. The cut tips did not grow indicating that the tips produced something essential for growth. In his second experiment he placed the agar blocks on the decapitated coleoptile tips. The coleoptile tips did not show any response. In his next experiment he placed the detached coleoptile tips on agar blocks. After an hour, he discarded the tips and placed this agar block on the decapitated coleoptile. It grew straight up indicating that some chemical had diffused from the cut coleoptile tips into the agar block which stimulated the growth.

From his experiments Went concluded that a chemical diffusing from the tip of coleoptiles was responsible for growth, and he named it as “**Auxin**” meaning ‘to grow’.

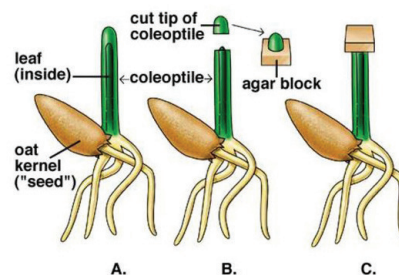

A. Germination of an oat seed  
B. Decapitate tip of coleoptile and place on agar block.  
C. Agar block is placed on top of the decapitated tip of the seedling.

Figure 16.2 Went’s Experiment

**Types of Auxins:** Auxins are classified into two types, namely natural auxins and synthetic auxins.

1. **Natural Auxins:** Auxins produced by the plants are called natural auxins. Example: IAA (Indole – 3 - Acetic Acid)
2. **Synthetic Auxins:** Artificially synthesized auxins that have properties like auxins are called as synthetic auxins. Example: 2, 4 D (2,4 Dichlorophenoxy Acetic Acid).

**Physiological effects of auxins:** Auxins bring about a variety of physiological effects in different parts of the plant body.

1. Auxins promote the **elongation of stems** and **coleoptiles** which makes them to grow.

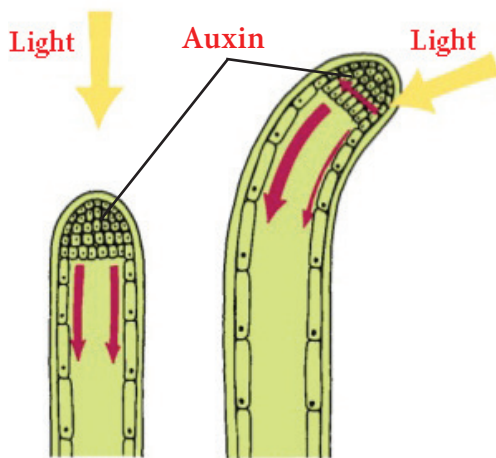

Figure 16.3 Cell Elongation

2. Auxins **induce root formation** at low concentration and inhibit it at higher concentration.
3. The auxins produced by the apical buds suppress growth of lateral buds. This is called **apical dominance**.
4. Seedless fruits without fertilization are induced by the external application of auxins. (**Parthenocarpy**). Examples: Watermelon, Grapes, Lime etc.
5. Auxins **prevent** the formation of **abscission layer**.



Phenyl Acetic Acid (PAA) and Indole 3 Acetonitrile (IAN) are natural auxins. Indole 3 Butyric Acid (IBA), Indole-3-Propionic Acid,  $\alpha$ -Naphthalene Acetic Acid (NAA), 2, 4, 5-T (2,4,5 Trichlorophenoxy Acetic Acid) are some of the synthetic auxins.

### 16.1.2 Cytokinins

Cytokinins (Cytos - cell; kinesis - division) are the plant hormones that **promote cell division** or cytokinesis in plant cells. It was first isolated from Herring fish sperm. Zeatin was the cytokinin isolated from *Zea mays*. Cytokinin is found abundantly in liquid endosperm of coconut.

### Physiological effects of cytokinins

1. Cytokinin induces **cell division** (cytokinesis) in the presence of auxins.
2. Cytokinin also causes **cell enlargement**.
3. Both auxins and cytokinins are essential for the formation of new organs from the callus in tissue culture (**Morphogenesis**).
4. Cytokinins promote the growth of **lateral buds** even in the presence of apical bud.
5. Application of cytokinin delays the process of ageing in plants. This is called **Richmond Lang effect**.

### 16.1.3 Gibberellins

Gibberellins are the most abundantly found plant hormones. Kurosawa (1926) observed **Bakanae disease** or **foolish seedling disease** in rice crops. This internodal elongation in rice was caused by fungus *Gibberella fujikuroi*. The active substance was identified as **Gibberellic acid**.

### Physiological effects of gibberellins

1. Application of gibberellins on plants stimulate extraordinary **elongation of internode**. e.g. Corn and Pea.

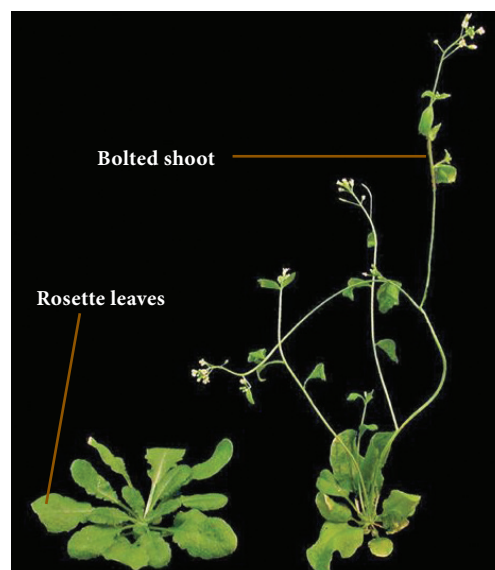

Figure 16.4 Bolting

2. Treatment of rosette plants with gibberellin induces sudden shoot elongation followed by flowering. This is called **bolting**.

- Gibberellins promote the **production of male flowers** in monoecious plants (Cucurbits).
- Gibberellins **break dormancy** of potato tubers.
- Gibberellins are efficient than auxins in inducing the formation of seedless fruit - **Parthenocarpic fruits** (Development of fruits without fertilization) e.g. Tomato.

### 16.1.4 Abscisic Acid

Abscisic acid (ABA) is a **growth inhibitor** which **regulates abscission** and **dormancy**. It increases tolerance of plants to various kinds of stress. So, it is also called as **stress hormone**. It is found in the chloroplast of plants.

#### Physiological effects of abscisic acid

- ABA promotes the process of **abscission** (separation of leaves, flowers and fruits from the branch).
- During water stress and drought conditions ABA **causes stomatal closure**.

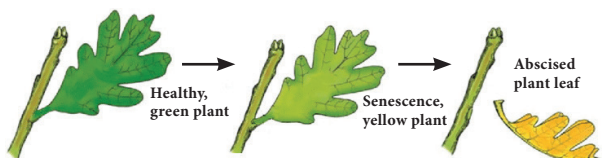

Figure 16.5 Senescence and abscission

#### Activity

Place two or three unripe tomatoes in a brown paper bag with a ripe bananas and roll the top closed. In another bag place two or three unripe tomatoes only and roll the top closed, Observe what happens to the tomatoes? Why?

As the banana continues to ripen in the first bag, it produces ethylene gas. The gas trapped in the bag will cause tomatoes to ripen. The tomatoes remain unripe in the second bag.

- ABA **promotes senescence** in leaves by causing loss of chlorophyll.
- ABA **induces bud dormancy** towards the approach of winter in trees like birch.
- ABA is a powerful **inhibitor of lateral bud growth** in tomato.

### 16.1.5 Ethylene

Ethylene is a **gaseous plant hormone**. It is a **growth inhibitor**. It is mainly concerned with maturation and ripening of fruits. Maximum synthesis of ethylene occurs during ripening of fruits like apples, bananas and melons

#### Physiological effects of ethylene

- Ethylene promotes the **ripening of fruits**. e.g. Tomato, Apple, Mango, Banana, etc.



Figure 16.6 Ethylene

- Ethylene **inhibits the elongation** of stem and root in dicots.
- Ethylene hastens the **senescence** of leaves and flowers.
- Ethylene stimulates **formation of abscission zone** in leaves, flowers and fruits. This leads to premature shedding.
- Ethylene **breaks the dormancy** of buds, seeds and storage organs.

## 16.2 Human Endocrine Glands

Endocrine glands in animals possess a versatile communication system to coordinate biological functions. Exocrine glands and endocrine glands are two kinds of glands found in animals. Endocrine glands are found in different regions of the body of animals as well as human beings. These glands are called **ductless**



**glands.** Their secretions are called **hormones** which are produced in **minute quantities**. The secretions diffuse into the blood stream and are carried to the distant parts of the body. They act on specific organs which are referred as **target organs**.

**DO YOU KNOW?** The branch of biology which deals with the study of the endocrine glands and its physiology is known as 'Endocrinology'. **Thomas Addison** is known as Father of Endocrinology. English physiologists **W. M. Bayliss** and **E. H. Starling** introduced the term **hormone** in 1909. They first discovered the hormone secretin.

Exocrine glands have specific ducts to carry their secretions e.g. salivary glands, mammary glands, sweat glands.

Endocrine glands present in human and other vertebrates are

- Pituitary gland
- Thyroid gland
- Parathyroid gland
- Pancreas (Islets of Langerhans)
- Adrenal gland (Adrenal cortex and Adrenal medulla)
- Gonads (Testes and Ovary)
- Thymus gland

### 16.2.1 Pituitary Gland

The **pituitary gland** or **hypophysis** is a pea shaped compact mass of cells located at the base of the midbrain attached to the hypothalamus by a **pituitary stalk**. The pituitary

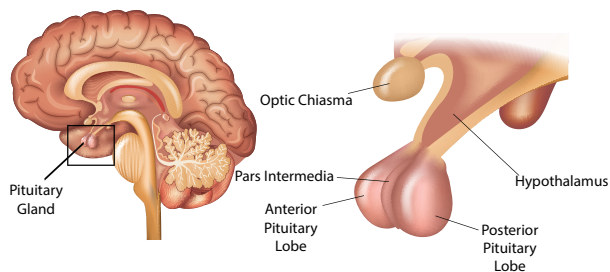

Figure 16.7 Pituitary Gland

gland is anatomically composed of two lobes and perform different functions. They are the anterior lobe (**adenohypophysis**) and the posterior lobe (**neurohypophysis**). The intermediate lobe is non-existent in humans.

The pituitary gland forms the major endocrine gland in most vertebrates. It regulates and controls other endocrine glands and so is called as the "**Master gland**".

#### Hormones secreted by the anterior lobe (Adenohypophysis) of pituitary

The anterior pituitary is composed of different types of cells and secrete hormones which stimulates the production of hormones by other endocrine glands. The hormones secreted by anterior pituitary are

- Growth Hormone
- Thyroid stimulating Hormone
- Adrenocorticotrophic Hormone
- Gonadotropic Hormone which comprises the Follicle Stimulating Hormone and Luteinizing Hormone
- Prolactin

#### a. Growth hormone (GH)

GH promotes the development and enlargement of all tissues of the body. It stimulates the growth of muscles, cartilage and long bones. It controls the cell metabolism.

The improper secretion of this hormone leads to the following conditions.

**Dwarfism:** It is caused by decreased secretion of growth hormone in children. The characteristic features are stunted growth, delayed skeletal formation and mental disability.

**Gigantism:** Oversecretion of growth hormone leads to gigantism in children. It is characterised by overgrowth of all body tissues and organs. Individuals attain abnormal increase in height.

**Acromegaly:** Excess secretion of growth hormone in adults may lead to abnormal enlargement of head, face, hands and feet.

**b. Thyroid stimulating hormone (TSH)**

TSH controls the growth of thyroid gland, coordinates its activities and hormone secretion.

**c. Adrenocorticotrophic hormone (ACTH)**

ACTH stimulates adrenal cortex of the adrenal gland for the production of its hormones. It also influences protein synthesis in the adrenal cortex.

**d. Gonadotropic hormones (GTH)**

The gonadotropic hormones are follicle stimulating hormone and luteinizing hormone which are essential for the normal development of gonads.

**Follicle stimulating hormone (FSH)**

In male, it stimulates the germinal epithelium of testes for formation of sperms. In female it initiates the growth of ovarian follicles and its development in ovary.

**Luteinizing hormone (LH)**

In male, it promotes the Leydig cells of the testes to secrete male sex hormone testosterone. In female, it causes ovulation (rupture of mature graafian follicle), responsible for the development of corpus luteum and production of female sex hormones estrogen and progesterone.

**e. Prolactin (PRL)**

PRL is also called **lactogenic hormone**. This hormone initiates development of mammary

glands during pregnancy and stimulates the production of milk after child birth.

**Hormones secreted by the posterior lobe (Neurohypophysis) of pituitary**

The hormones secreted by the posterior pituitary are

- a. Vasopressin or Antidiuretic hormone
- b. Oxytocin

**a. Vasopressin or Antidiuretic hormone (ADH)**

In kidney tubules it increases reabsorption of water. It reduces loss of water through urine and hence the name antidiuretic hormone.

Deficiency of ADH reduces reabsorption of water and causes an increase in urine output (polyuria). This deficiency disorder is called **Diabetes insipidus**.

**b. Oxytocin**

It helps in the contraction of the smooth muscles of uterus at the time of child birth and milk ejection from the mammary gland after child birth.

**16.2.2 Thyroid Gland**

The thyroid gland is composed of two distinct lobes lying one on either side of the trachea. The two lobes are connected by means of a narrow band of tissue known as the **isthmus**. This gland is composed of glandular follicles and

**More to Know**

Melatonin is a hormone produced by the pineal gland. It is known as a 'time messenger'. It signals night time information throughout the body.

Exposure to light at night, especially short-wavelength light, can decrease melatonin production interrupting sleep. Suppression of melatonin has been implicated in sleep disturbances and related metabolic disorders.

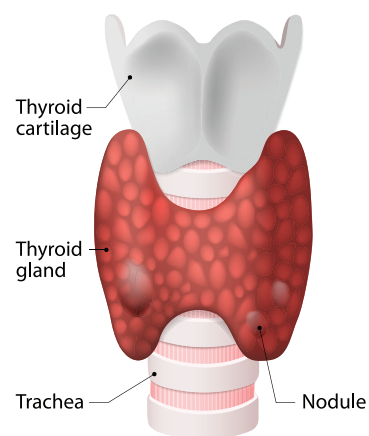

**Figure 16.8** Thyroid Gland

lined by cuboidal epithelium. The follicles are filled with colloid material called **thyroglobulin**.

An amino acid **tyrosine** and **iodine** are involved in the formation of thyroid hormone. The hormones secreted by the thyroid gland are

- a. Triiodothyronine ( $T_3$ )
- b. Tetraiodothyronine or Thyroxine ( $T_4$ )

### Functions of thyroid hormones

The functions of thyroid hormones are

- ◆ Production of energy by maintaining the **Basal Metabolic Rate** (BMR) of the body.
- ◆ Helps to maintain normal body temperature.
- ◆ Influences the activity of central nervous system.
- ◆ Controls growth of the body and bone formation.
- ◆ Essential for normal physical, mental and personality development .
- ◆ It is also known as **personality hormone**.
- ◆ Regulates cell metabolism.

### More to Know

Edward C. Kendal in 1914 first crystallised thyroxine hormone. Charles Harrington and George Barger identified the molecular structure of thyroxine in 1927. Thyroid gland requires “120  $\mu\text{g}$ ” of iodine everyday for the production of thyroxine.

### Thyroid Dysfunction

When the thyroid gland fails to secrete the normal level of hormones, the condition is called **thyroid dysfunction**. It leads to the following conditions

### Hypothyroidism

It is caused due to the decreased secretion of the thyroid hormones. The abnormal conditions are simple goitre, cretinism and myxoedema.

### Goitre

It is caused due to the inadequate supply of iodine in our diet. This is commonly prevalent in Himalayan regions due to low level of iodine content in the soil. It leads to the enlargement of thyroid gland which protrudes as a marked swelling in the neck and is called as **goitre**.



### Cretinism

It is caused due to decreased secretion of the thyroid hormones in children. The conditions are stunted growth, mental defect, lack of skeletal development and deformed bones. They are called as **cretins**.

### Myxoedema

It is caused by deficiency of thyroid hormones in adults. They are mentally sluggish, increase in body weight, puffiness of the face and hand, oedematous appearance.

### Hyperthyroidism

It is caused due to the excess secretion of the thyroid hormones which leads to Grave's disease. The symptoms are protrusion of the eyeballs (Exophthalmia), increased metabolic rate, high body temperature, profuse sweating, loss of body weight and nervousness.

### 16.2.3 Parathyroid Gland

The parathyroid glands are four small oval bodies that are situated on the posterior surface of the thyroid lobes. The **chief cells** of the gland are mainly concerned with secretion of **parathormone**.

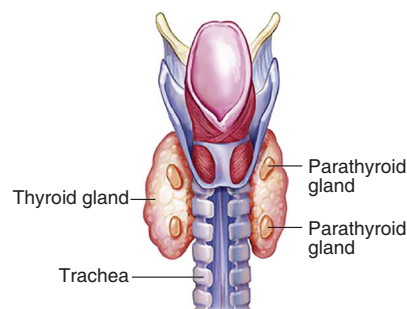

Figure 16.9 Parathyroid Gland

### Functions of Parathormone

The parathormone regulates calcium and phosphorus metabolism in the body. They act on bone, kidney and intestine to maintain blood calcium levels.

### Parathyroid Dysfunction

The secretion of parathyroid hormone can be altered due to the following conditions.

Removal of parathyroid glands during thyroidectomy (removal of thyroid) causes decreased secretion of parathormone. The conditions are

- Muscle spasm known as **Tetany** (sustained contraction of muscles in face, larynx, hands and feet).
- Painful cramps of the limb muscles.

### 16.2.4 Pancreas (Islets of Langerhans)

Pancreas is an elongated, yellowish gland situated in the loop of stomach and duodenum. It is **exocrine** and **endocrine** in nature. The exocrine pancreas secretes pancreatic juice which plays a role in digestion while, the endocrine portion is made up of Islets of Langerhans.

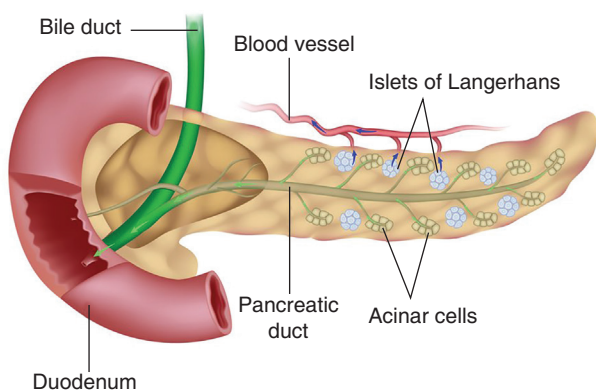

Figure 16.10 Pancreas

**DO YOU KNOW?** Human insulin was first discovered by Fredrick Banting, Charles Best and MacLeod in 1921. Insulin was first used in treatment of diabetes on 11<sup>th</sup> January 1922.

The Islets of Langerhans consists of two types of cells namely alpha cells and beta cells. The **alpha cells** secrete **glucagon** and **beta cells** secrete **insulin**.

### Functions of Pancreatic hormones

A balance between insulin and glucagon production is necessary to maintain blood glucose concentration.

#### Insulin

- Insulin helps in the conversion of glucose into glycogen which is stored in liver and skeletal muscles.
- It promotes the transport of glucose into the cells.
- It decreases the concentration of glucose in blood.

#### Glucagon

- Glucagon helps in the breakdown of glycogen to glucose in the liver.
- It increases blood glucose levels.

#### Diabetes mellitus

The deficiency of insulin causes **Diabetes mellitus**. It is characterised by

- Increase in blood sugar level (Hyperglycemia).
- Excretion of excess glucose in the urine (Glycosuria).
- Frequent urination (Polyuria).
- Increased thirst (Polydipsia).
- Increase in appetite (Polyphagia).

### 16.2.5 Adrenal Gland

The adrenal glands are located above each kidney. They are also called **supra renal glands**.

The outer part is the adrenal cortex and the inner part is the adrenal medulla. The two distinct parts are structurally and functionally different.

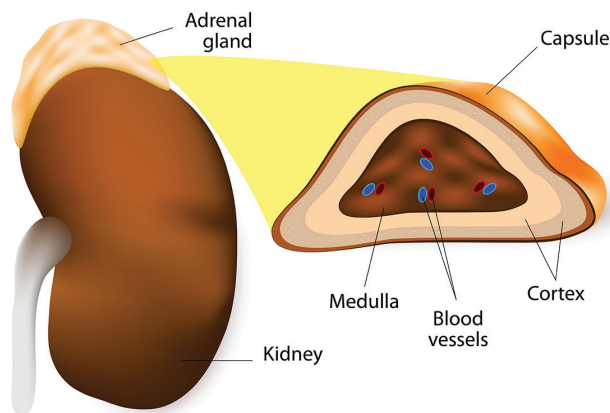

Figure 16.11 Adrenal Gland

### Adrenal Cortex

The adrenal cortex consists of three layers of cells. They are **zona glomerulosa**, **zona fasciculata** and **zona reticularis**

#### Hormones of Adrenal Cortex

The hormones secreted by the adrenal cortex are corticosteroids. They are classified into

- a. Glucocorticoids
- b. Mineralocorticoids

#### Functions of adrenocortical hormones

##### Glucocorticoids

The glucocorticoids secreted by the zona fasciculata are **cortisol** and **corticosterone**

- They regulate cell metabolism.
- It stimulates the formation of glucose from glycogen in the liver.
- It is an anti-inflammatory and anti-allergic agent.

##### Mineralocorticoids

The mineralocorticoids secreted by zona glomerulosa is **aldosterone**

- It helps to reabsorb sodium ions from the renal tubules.
- It causes increased excretion of potassium ions.

- It regulates electrolyte balance, body fluid volume, osmotic pressure and blood pressure.

#### More to Know

The **cortisol** hormones of adrenal cortex serves to maintain the body in living condition and recover it from the severe effects of stress reactions. Thus an increased output of cortisol is “life saving” in “shock conditions”. It is also known as life-saving hormone.

### Adrenal Medulla

The adrenal medulla is composed of **chromaffin cells**. They are richly supplied with sympathetic and parasympathetic nerves.

#### Hormones of Adrenal Medulla

It secretes two hormones namely

- a. Epinephrine (Adrenaline)
- b. Norepinephrine (Noradrenaline)

They are together called as “**Emergency hormones**”. It is produced during conditions of stress and emotion. Hence it is also referred as “flight, fright and fight hormone”.

#### Functions of adrenal medullary hormones

##### Epinephrine (Adrenaline)

- It promotes the conversion of glycogen to glucose in liver and muscles.
- It increases heart beat and blood pressure.
- It increases the rate of respiration by dilation of bronchi and trachea.
- It causes dilation of the pupil in eye.
- It decreases blood flow through the skin.

##### Norepinephrine (Noradrenalin)

Most of its actions are similar to those of epinephrine.

### 16.2.6 Reproductive Glands (Gonads)

The sex glands are of two types the **testes** and the **ovaries**. The testes are present in male, while the ovaries are present in female.

## Testes

Testes are the reproductive glands of the males. They are composed of seminiferous tubules, Leydig cells and Sertoli cells. **Leydig cells** form the endocrine part of the testes. They secrete the male sex hormone called **testosterone**.

### Functions of testosterone

- It influences the process of spermatogenesis.
- It stimulates protein synthesis and controls muscular growth.
- It is responsible for the development of secondary sexual characters (distribution of hair on body and face, deep voice pattern, etc).

## Ovary

The ovaries are the female gonads located in the pelvic cavity of the abdomen. They secrete the female sex hormones

- Estrogen
- Progesterone

**Estrogen** is produced by the **Graafian follicles** of the ovary and **progesterone** from the **corpus luteum** that is formed in the ovary from the ruptured follicle during ovulation.

### Functions of estrogens

- It brings about the changes that occur during puberty.
- It initiates the process of oogenesis.
- It stimulates the maturation of ovarian follicles in the ovary.
- It promotes the development of secondary sexual characters (breast development, high pitched voice etc).

### Functions of progesterone

- It is responsible for the premenstrual changes of the uterus.
- It prepares the uterus for the implantation of the embryo.

- It maintains pregnancy.
- It is essential for the formation of placenta.

## 16.2.7 Thymus Gland

Thymus is partly an endocrine gland and partly a lymphoid gland. It is located in the upper part of the chest covering the lower end of trachea. **Thymosin** is the hormone secreted by thymus.

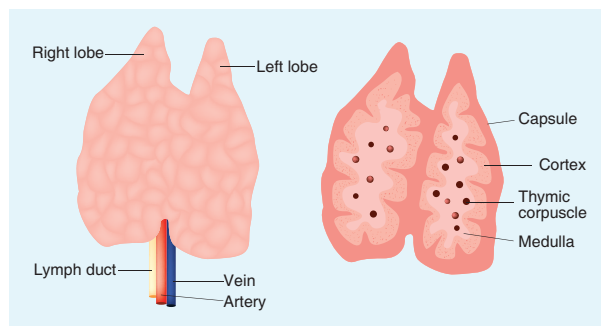

Figure 16.12 Thymus Gland

### Functions of Thymosin

- It has a stimulatory effect on the immune function.
- It stimulates the production and differentiation of lymphocytes.

### Points to Remember

- ❖ Auxins are produced at the tip of stems and roots from where they migrate to the zone of elongation.
- ❖ Cytokinins are the plant hormones that promote cell division or cytokinesis in plant cells.
- ❖ Gibberellins induce the formation of seedless fruit and parthenocarpic fruits.
- ❖ Abscisic acid is a growth inhibitor which regulates abscission and dormancy. It increases tolerance of plants to various kinds of stress.
- ❖ Ethylene is a gaseous plant hormone mainly concerned with maturation and ripening of fruits.

- ❖ The pituitary gland regulates and controls other endocrine glands and so is called as the “Master gland”.
- ❖ The hormones secreted by the thyroid gland are triiodothyronine ( $T_3$ ), and tetraiodothyronine or thyroxine ( $T_4$ )
- ❖ The parathormone act on bone, kidney and intestine to maintain blood calcium levels.
- ❖ Pancreas secretes insulin and glucagon. They maintain blood glucose level.
- ❖ Adrenal cortex secrete cortisol and aldosterone and adrenal medulla secretes epinephrine and norepinephrine.
- ❖ The sex glands are of two types the testes and the ovaries which secrete testosterone and estrogens respectively.



### TEXTBOOK EVALUATION



#### I Choose the correct answer

1. Gibberellins cause:
  - a) Shortening of genetically tall plants
  - b) Elongation of dwarf plants
  - c) Promotion of rooting
  - d) Yellowing of young leaves
2. The hormone which has positive effect on apical dominance is:
  - a) Cytokinin
  - b) Auxin
  - c) Gibberellin
  - d) Ethylene
3. Which one of the following hormones is naturally not found in plants:
  - a) 2, 4-D
  - b) GA3
  - c) Gibberellin
  - d) IAA
4. Avena coleoptile test was conducted by
  - a) Darwin
  - b) N. Smit
  - c) Paal
  - d) F.W. Went
5. To increase the sugar production in sugarcanes they are sprayed with \_\_\_\_\_
  - a) Auxin
  - b) Cytokinin
  - c) Gibberellins
  - d) Ethylene
6. LH is secreted by
  - a) Adrenal gland
  - b) Thyroid gland
  - c) Anterior pituitary
  - d) Hypothalamus.
7. Identify the exocrine gland
  - a) Pituitary gland
  - b) Adrenal gland
  - c) Salivary gland
  - d) Thyroid gland

8. Which organ acts as both exocrine gland as well as endocrine gland
  - a) Pancreas
  - b) Kidney
  - c) Liver
  - d) Lungs
9. Which one is referred as “Master Gland”?
  - a) Pineal gland
  - b) Pituitary gland
  - c) Thyroid gland
  - d) Adrenal gland

#### II Fill in the blanks

1. \_\_\_\_\_ causes cell elongation, apical dominance and prevents abscission.
2. \_\_\_\_\_ is a gaseous hormone involved in abscission of organs and acceleration of fruit ripening.
3. \_\_\_\_\_ causes stomatal closure.
4. Gibberellins induce stem elongation in \_\_\_\_\_ plants.
5. The hormone which has negative effect on apical dominance is \_\_\_\_\_.
6. Calcium metabolism of the body is controlled by \_\_\_\_\_.
7. In the islets of Langerhans, beta cells secrete \_\_\_\_\_.
8. The growth and functions of thyroid gland is controlled by \_\_\_\_\_.
9. Decreased secretion of thyroid hormones in the children leads to \_\_\_\_\_.

**III a) Match Column I with Columns II and III**

Column I	Column II	Column III
Auxin	<i>Gibberella fujikuroi</i>	Abscission
Ethylene	Coconut milk	Internodal elongation
Abscisic acid	Coleoptile tip	Apical dominance
Cytokinin	Chloroplast	Ripening
Gibberellins	Fruits	Cell division

**III b) Match the following hormones with their deficiency states**

<i>Hormones</i>	<i>Disorders</i>
a) Thyroxine	- Acromegaly
b) Insulin	- Tetany
c) Parathormone	- Simple goitre
d) Growth hormone	- Diabetes insipidus
e) ADH	- Diabetes mellitus

**IV State whether True or false, If false write the correct statement**

- A plant hormone concerned with stimulation of cell division and promotion of nutrient mobilization is cytokinin.
- Gibberellins cause parthenocarp in tomato.
- Ethylene retards senescence of leaves, flowers and fruits.
- Exophthalmic goiter is due to the over secretion of thyroxine.
- Pituitary gland is divided into four lobes.
- Estrogen is secreted by corpus luteum.

**V Assertion and Reasoning**

**Direction:** In each of the following questions a statement of assertion (A) is given and a corresponding statement of reason (R) is given just below it. Mark the correct statement as.

- If both A and R are true and R is correct explanation of A
  - If both A and R are true but R is not the correct explanation of A
  - A is true but R is false
  - Both A and R are false
- Assertion:** Application of cytokinin to marketed vegetables can keep them fresh for several days.  
**Reason:** Cytokinins delay senescence of leaves and other organs by mobilisation of nutrients.
  - Assertion (A):** Pituitary gland is referred as “Master gland”.  
**Reason (R):** It controls the functioning of other endocrine glands.
  - Assertion (A):** Diabetes mellitus increases the blood sugar levels.  
**Reason (R):** Insulin decreases the blood sugar levels.

**VI Answer in a word or sentence**

- Which hormone promotes the production of male flowers in Cucurbits?
- Write the name of a synthetic auxin.
- Which hormone induces parthenocarp in tomatoes?
- What is the hormone responsible for the secretion of milk in female after child birth?
- Name the hormones which regulates water and mineral metabolism in man.
- Which hormone is secreted during emergency situation in man?
- Which gland secretes digestive enzymes and hormones?
- Name the endocrine glands associated with kidneys.

**VII Short answer questions**

- What are synthetic auxins? Give examples.
- What is bolting? How can it be induced artificially?



3. Bring out any two physiological activities of abscisic acid
4. What will you do to prevent leaf fall and fruit drop in plants? Support your answer with reason.
5. What are chemical messengers?
6. Write the differences between endocrine and exocrine gland.
7. What is the role of parathormone?
8. What are the hormones secreted by posterior lobe of the pituitary gland? Mention the tissues on which they exert their effect.
9. Why are thyroid hormones referred as personality hormone?
10. Which hormone requires iodine for its formation? What will happen if intake of iodine in our diet is low?

**VIII. Long answer questions**

1. (a) Name the gaseous plant hormone. Describe its three different actions in plants.  
(b) Which hormone is known as stress hormone in plants? Why?
2. Describe an experiment which demonstrates that growth stimulating hormone is produced at the tip of coleoptile.
3. Write the physiological effects of gibberellins.
4. Where are estrogens produced? What is the role of estrogens in the human body?
5. What are the conditions which occur due to lack of ADH and insulin? How are the conditions different from one another?

**IX Higher Order Thinking Skills (HOTS)**

1. What would be expected to happen if
  - a. Gibberellin is applied to rice seedlings.
  - b. A rotten fruit gets mixed with unripe fruits.
  - c. When cytokinin is not added to culture medium

2. A plant hormone was first discovered in Japan when rice plants were suffering from Bakanae disease caused by *Gibberella fujikuroi*. Based on this information answer the following questions:
  - a. Identify the hormone involved in this process.
  - b. Which property of this hormone causes the disease?
  - c. Give two functions of this hormone.
3. Senthil has high blood pressure, protruded eyeball and an increased body temperature. Name the endocrine gland involved and hormone secretion responsible for this condition.
4. Sanjay is sitting in the exam hall. Before the start of the exam, he sweats a lot, with increased rate of heart beat. Why does this condition occur?
5. Susan's father feels very tired and frequently urinates. After clinical diagnosis he was advised to take an injection daily to maintain his blood glucose level. What would be the possible cause for this? Suggest preventive measures.



**REFERENCE BOOKS**

1. Helgi Opik and Stephen Rolfe, The Physiology of Flowering Plants, Cambridge University Press.
2. Berry AK, A Textbook of Endocrinology, 11<sup>th</sup> edition, Emkay Publications, New Delhi
3. Prakash S Lohar, Endocrinology, Hormones and Human Health, MJP Publishers (TamilNadu Book House), Chennai



**INTERNET RESOURCES**

1. <https://www.biologydiscussion.com> > auxins-his
2. [https://www.mcdaniel.edu/biology/Bot.\(dia\)](https://www.mcdaniel.edu/biology/Bot.(dia))
3. <https://www.ndsu.edu/pubweb/chiwonlee/plsc210>

### Concept Map

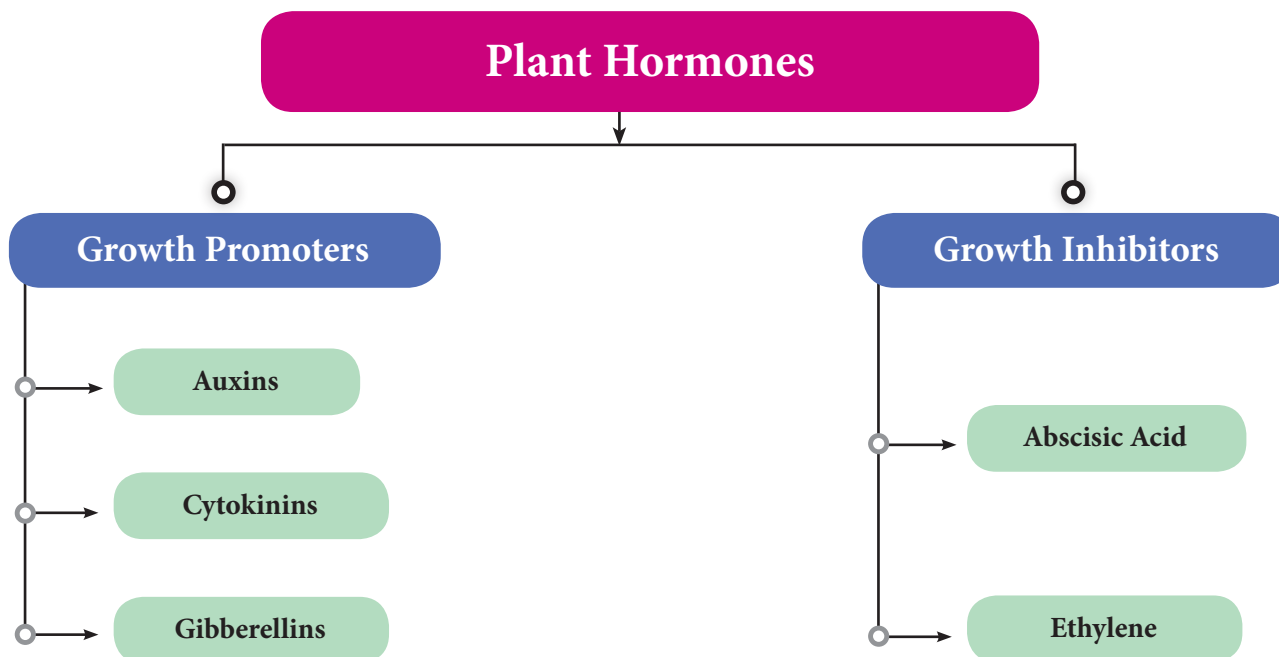

### Human Endocrine Glands - Concept Map

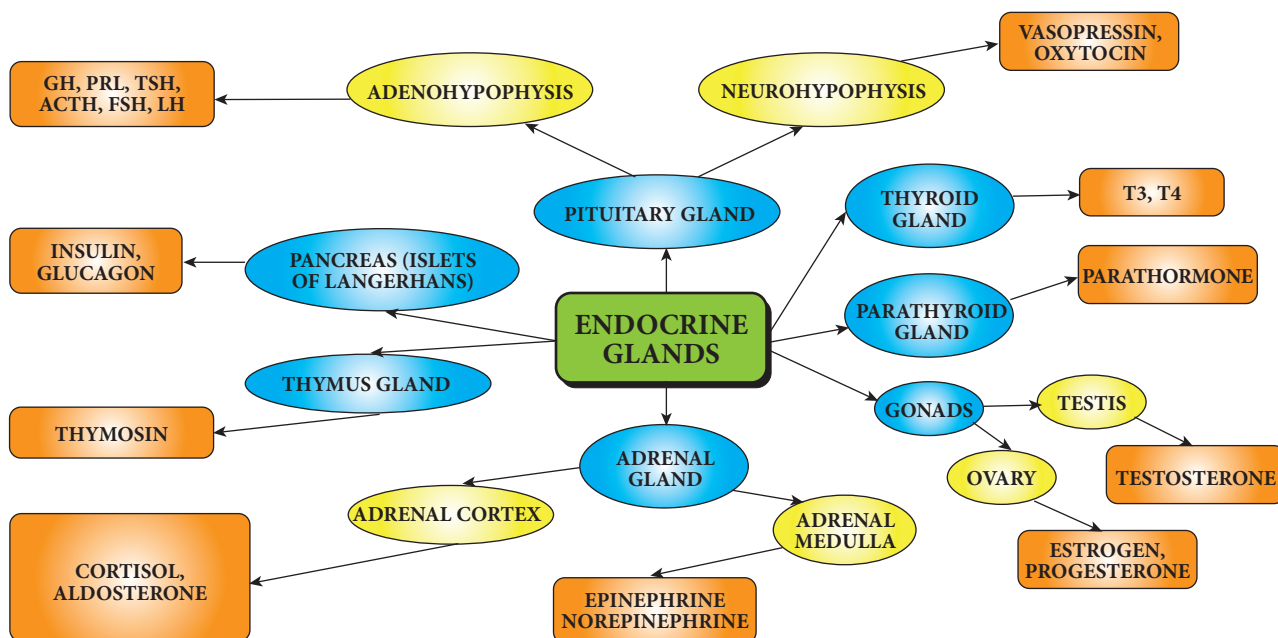

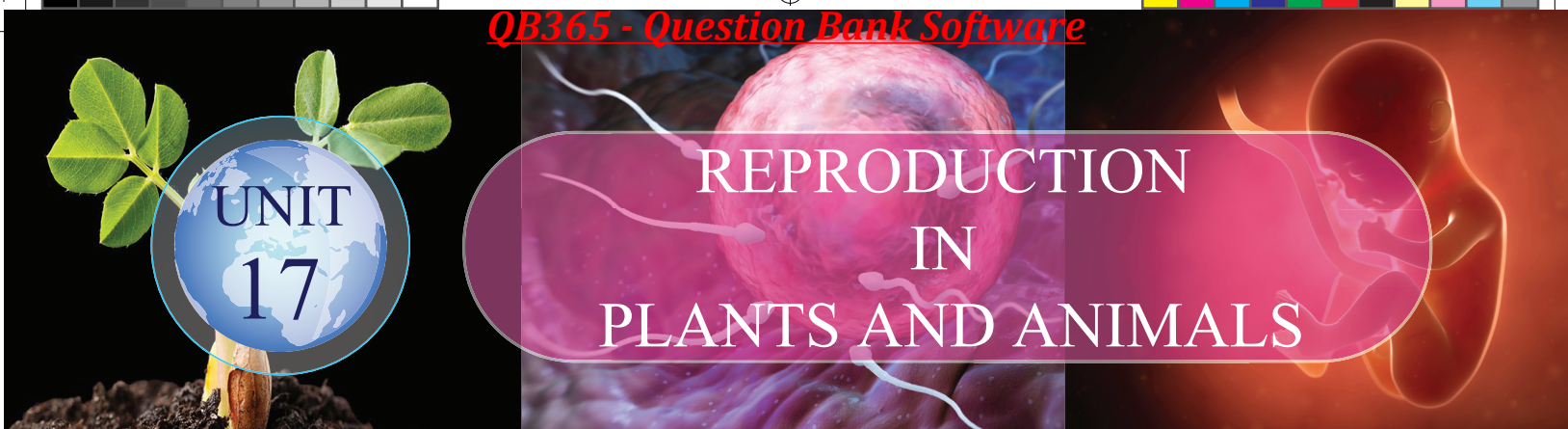

## Learning Objectives



PNKGM7

At the end of this lesson the students will be able to:

- ◆ Differentiate vegetative, asexual and sexual reproduction.
- ◆ Describe parts of flower and their functions.
- ◆ Understand the types and modes of pollination and their significance.
- ◆ Understand the process of double fertilization, steps involved in fertilization (syngamy and triple fusion), embryo development, endosperm development and formation of seed.
- ◆ Understand the process of sexual reproduction in human beings.
- ◆ Know the structure of testicular and ovarian cells.
- ◆ Know the structural details of human sperm and ovum.
- ◆ Realize the events of menstrual cycle and fertilization.
- ◆ Gain awareness on reproductive health and strategies.
- ◆ Gain knowledge on personal and social hygiene.

## Introduction

“Living organisms cannot survive for an indefinite period on earth. All living organisms have the ability to produce more of its own kind by the process called reproduction. Reproduction is the unfolding of life forms where new individuals are formed. It ensures continuity and survival of the species. This process is to preserve individual species and it is called as self-perpetuation. The time required to reproduce also varies from organism to organism. You may find great variations in period of reproduction in yeast, bacteria, rat, cow, elephant and humans. In sexual reproduction offsprings are produced

by the union of male and female gametes (sperm and egg). The male and female gametes contain the genetic material or genes present on the chromosomes which transmit the characteristic traits to the next generation. There are three types of reproduction in plants namely i) Vegetative ii) Asexual and iii) Sexual reproduction.

### 17.1 Vegetative Reproduction

In this type, new plantlets are formed from vegetative (somatic) cells, buds or organs of plant. The vegetative part of plant (root, stem, leaf or bud) gets detached from the parent body and grows into an independent

daughter plant. It has only mitotic division, no gametic fusion and daughter plants are genetically similar to the parent plant.

Vegetative reproduction may take place through

(i) **Leaves:** In Bryophyllum small plants grow at the leaf notches



Figure 17.1 Vegetative reproduction by leaf

(ii) **Stems:** In strawberry aerial weak stems touch the ground and give off adventitious roots and buds. When the connections with the parent plant is broken, the offspring becomes independent.

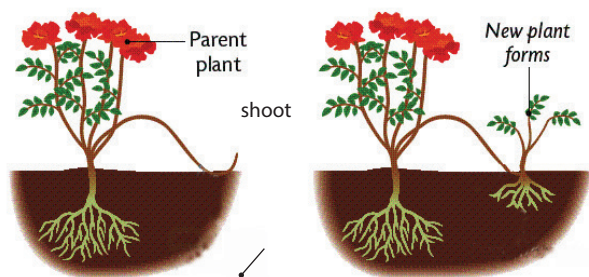

Figure 17.2 Vegetative reproduction by stem

(iii) **Root:** Tuberos roots (Asparagus and Sweet potato) can be used for vegetative propagation.

(iv) **Bulbils:** In some plants the flower buds modified into globose which are called as bulbils. When these falls on the ground they grow into new plants. e.g. Agave.

(v) **Other types of Vegetative Reproduction**

**a. Fragmentation:** In filamentous algae, breaking of the filament into many fragments is called fragmentation. Each fragment having

at least one cell, may give rise to a new filament of the algae by cell division e.g. Spirogyra.

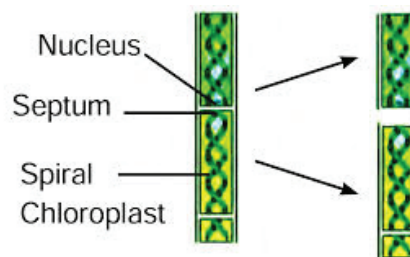

Figure 17.3 Fragmentation in Spirogyra

**b. Fission:** In this type the parent cell divides into two daughter cells and each cell develops into a new adult organism e.g. Amoeba.

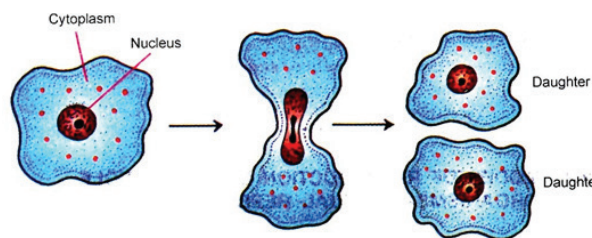

Figure 17.4 Fission in Amoeba

**c. Budding:** Formation of a daughter individual from a small projection, the bud, arising on the parent body is called budding. e.g. Yeast.



Figure 17.5 Budding in Yeast

**d. Regeneration:** The ability of the lost body parts of an individual organism to give rise to an whole new organism is called regeneration. It takes place by specialized mass of cells e.g. *Hydra* and *Planaria*.

## 17.2 Asexual Reproduction

Production of an offspring by a single parent without the formation and fusion of gametes is called asexual reproduction. It involves only mitotic cell divisions and meiosis does not occur. Offspring produced by asexual reproduction are not only identical to parents but are also exact copies of their parent.

Asexual reproduction occurs by **spore formation**. This is the most common method of asexual reproduction in fungi and bacteria.

During spore formation a structure called **sporangium** develops from the **fungal hypha**. The nucleus divides several times within the sporangium and each nucleus with small amount of cytoplasm develops into a spore. The spores are liberated and they develop into new hypha after reaching the ground or substratum.

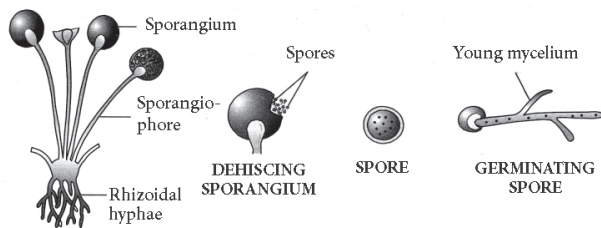

Figure 17.6 Spore formation in *Rhizopus*

### Activity 1

- ◆ Wet a slice of bread, and keep it in a cool, moist and dark place.
- ◆ Observe the surface of the slice with a magnifying glass.
- ◆ Record your observations for a week.

## 17.3 Sexual Reproduction in Plants

Sexual reproduction is the process in which two gametes (male and female) are fused to produce offspring of their own kind. In such cases both sexes, male and female sex organs are needed to produce gametes. You have already learnt that the flower is a reproductive organ of a flowering plant.

To understand this further we need to study the structure of a flower.

### 17.3.1 Parts of a Typical Flower

A flower is a modified shoot with limited growth to carry out sexual reproduction. A flower consists of four whorls borne on a thalamus. These whorls are from outside

- a) Calyx – consisting of sepals
- b) Corolla – consisting of petals
- c) Androecium – consisting of stamens
- d) Gynoecium or pistil – consisting of carpels

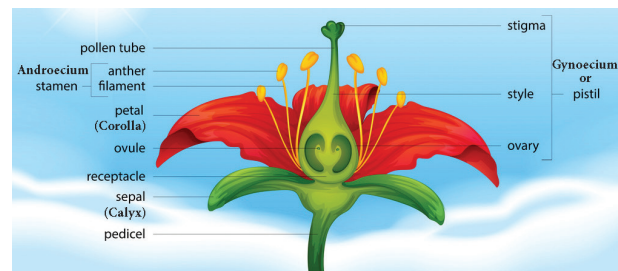

Figure 17.7 Parts of a flower

### Activity 2

- ◆ Take a shoe flower from a growing plant.
- ◆ Observe the floral parts Calyx, Corolla, Androecium and Gynoecium.
- ◆ Separate the stamens and carpels and observe the parts.
- ◆ Dust the pollen grains on a slide and observe under a microscope.

The **two outermost whorls calyx and corolla** are **non-essential** or **accessory whorls** as they do not directly take part in the reproduction. The other two whorls **androecium** and **gynoecium** are known as the **essential whorls**, because both take part directly in reproduction.

**Androecium:** Androecium, the **male part** of flower is composed of **stamens**. Each stamen consists of a stalk called the **filament** and a small bag like structure called **anther** at the tip. The pollen grains are produced in the anther within the pollen sac.

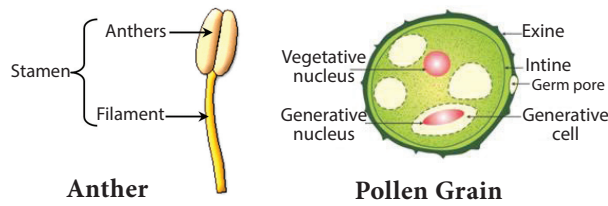

**Figure 17.8** Structure of Anther and Pollen grain

**Pollen grain:** Pollen grains are usually spherical in shape. It has two layered wall. The hard-outer layer is known as **exine**. It has prominent apertures called germ pore. The inner thin layer is known as **intine**. It is a thin and continuous layer made up of cellulose and pectin. Mature pollen grains contain two cells, the **vegetative** and the **generative cell**. Vegetative cell contains a large nucleus. The generative cell divides mitotically to form two male gametes.

**Gynoecium:** Gynoecium is the female part of the flower and is made up of carpels. It has three parts:

1. Ovary
2. Style
3. Stigma

The ovary contains the ovules.

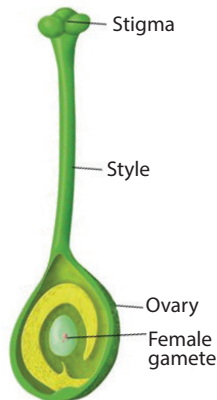

**Figure 17.9** Gynoecium

### 17.3.2 Structure of the Ovule

The main part of the ovule is the **nucellus** which is enclosed by two integuments leaving an opening called as **micropyle**. The ovule is attached to the ovary wall by a stalk known as **funiculus**. **Chalaza** is the basal part.

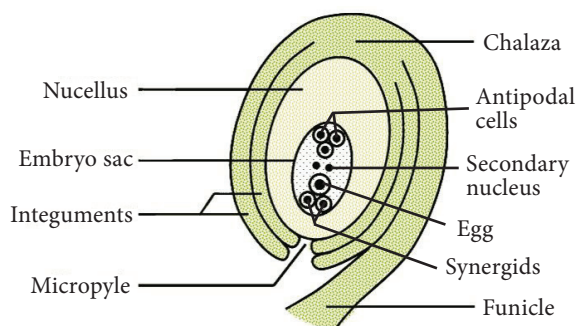

**Figure 17.10** Structure of an Ovule

The embryo sac contains seven cells and the eighth nuclei located within the **nucellus**. Three cells at the **micropylar** end form the egg apparatus and the three cells at the **chalaza** end are the antipodal cells. The remaining two nuclei are called **polar nuclei** found in the centre. In the egg apparatus one is the egg cell (female gamete) and the remaining two cells are the **synergids**.

Process of sexual reproduction in flowering plants. It involves:

1. Pollination
2. Fertilization

## 17.4 Pollination

The transfer of pollen grains from anther to stigma of a flower is called as pollination



### Importance of Pollination

1. It results in fertilization which leads to the formation of fruits and seed.
2. New varieties of plants are formed through new combination of genes in case of cross pollination.

### 17.4.1 Types of Pollination

1. Self-pollination
2. Cross pollination

#### Self-pollination (Autogamy)

Self-pollination is also known as autogamy. The transfer of pollen grains from the anther to the stigma of same flower or another flower borne on the same plant is known as self-pollination. e.g. *Hibiscus*.

#### Advantages of self-pollination

1. Self-pollination is possible in bisexual flowers.
2. Flowers do not depend on agents for pollination.
3. There is no wastage of pollen grains.

**Disadvantages of self-pollination**

1. The seeds are less in numbers.
2. The endosperm is minute. Therefore, the seeds produce weak plants.
3. New varieties of plants cannot be produced

**Cross pollination**

Cross-pollination is the transfer of pollen from the anthers of a flower to the stigma of a flower on another plant of the same species e.g. apples, grapes, plum, etc.

**Advantages of cross pollination**

1. The seeds produced as a result of cross pollination, develop and germinate properly and grow into better plants, i.e. cross pollination leads to the production of new varieties.
2. More viable seeds are produced.

**Disadvantages of cross-pollination**

1. Pollination may fail due to distance barrier.
2. More wastage of pollen grains
3. It may introduce some unwanted characters
4. Flowers depend on the external agencies for pollination

**Activity 3**

- ◆ Observe the flowers in a garden. Identify the insects and birds that act as pollinating agents.
- ◆ Maintain a record of pollinating agents and the plants.

**17.5 Agents of Cross Pollination**

In order to bring about cross pollination, it is necessary that the pollen should be carried from one flower to another of a different plant.

This takes place through the agency of animals, insects, wind and water.

**1. Pollination by wind**

The pollination with the help of wind is called **anemophily**. The anemophilous flowers produce enormous amount of pollen grains. The pollen grains are small, smooth, dry and light in weight. Pollen of such plants are blown off at a distance of more than 1,000 km. The stigmas are comparatively large, protruding and sometimes hairy to trap the pollen grains. e.g. Grasses and some cacti.

**2. Pollination by insects**

Pollination with the help of insects like honey bees, flies are called **entomophily**. To attract insects these flowers are brightly coloured, have smell and nectar. The pollen grains are larger in size, the exine is pitted, spiny etc., so they can be adhered firmly on the sticky stigma. Approximately, 80% of the pollination done by the insects is carried by honey bees.

**3. Pollination by water**

The pollination with the help of water is called **hydrophily**. This takes place in aquatic plants.

- (i) Pollen grains are produced in large numbers.
- (ii) Pollen grains float on surface of water till they land on the stigma of female flowers e.g. *Hydrilla*, *Vallisneria*.

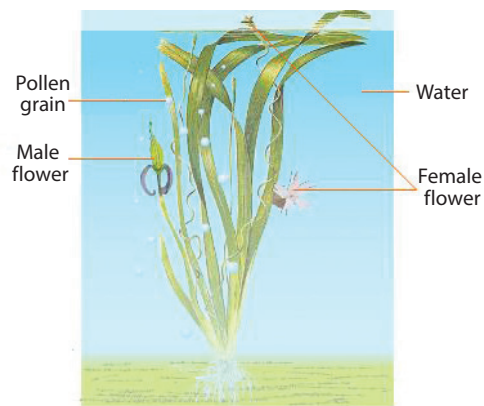

Figure 17.11 Hydrophily

### 3. Pollination by Animals

When pollination takes place with the help of animals, it is called **Zoophily**. Flowers of such plants attract animals by their bright color, size, scent etc. e.g. sun bird pollinates flowers of *Canna*, *Gladioli* etc., Squirrels pollinate flowers of silk cotton tree.

## 17.6 Fertilization in Plants

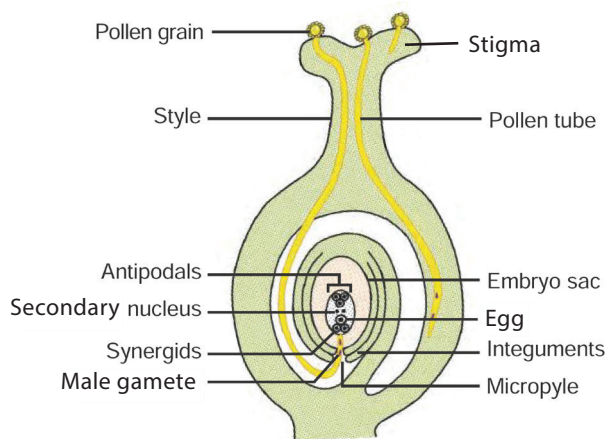

Figure 17.12 Process of Fertilization

- ◆ Pollen grains reach the right stigma and begin to germinate.
- ◆ Pollen grain forms a small tube-like structure called pollen tube which emerges through the germ pore. The contents of the pollen grain move into the tube.
- ◆ Pollen tube grows through the tissues of the stigma and style and finally reaches the ovule through the micropyle.
- ◆ Vegetative cell degenerates and the generative cell divides to form two sperms (or male gametes).
- ◆ Tip of pollen tube bursts and the two sperms enter the embryo sac.
- ◆ One sperm fuses with the egg (syngamy) and forms a diploid zygote. The other sperm fuses with the secondary nucleus (Triple fusion) to form the primary endosperm nucleus which is triploid in nature. Since

two types of fusion syngamy and triple fusion take place in an embryo sac the process is termed as **double fertilization**.

- ◆ After triple fusion, primary endosperm nucleus develops into an endosperm.
- ◆ Endosperm provides food to the developing embryo.
- ◆ Later the synergids and antipodal cells degenerate.

### Significance of Fertilization

- (i) It stimulates the ovary to develop into fruit.
- (ii) It helps in development of new characters from two different individuals.

### Post fertilization changes:

1. The ovule develops into a seed.
2. The integuments of the ovule develop into the seed coat.
3. The ovary enlarges and develops into a fruit.

The seed contains the future plant or embryo which develops into a seedling under appropriate conditions.

## 17.7 Sexual Reproduction in Human

You have studied the structural details of the male and female reproductive system in 9<sup>th</sup> standard. In human beings the male and female reproductive organs differ anatomically and physiologically. New individuals develop by the fusion of gametes. Sexual reproduction involves the fusion of two haploid gametes (male and the female gametes) to form a diploid individual (zygote).

Organs of the reproductive system are divided into primary and secondary (accessory) sex organs.



- ◆ Primary reproductive organs include the gonads (Testes in male and Ovaries in female).
- ◆ Accessory sex organs
  - ❖ **Male:** Vas deferens, epididymis, seminal vesicle, prostate gland and penis.
  - ❖ **Female:** Fallopian tubes, uterus, cervix and vagina.

The secondary (accessory) sex organs include those structures which are involved in the

- ◆ Process of ovulation
- ◆ Fusion of the male and female gametes (fertilization)
- ◆ Division of the fertilized egg upto the formation of embryo
- ◆ Pregnancy
- ◆ Development of foetus
- ◆ Child birth.

Now let's see the cells of the primary reproductive organs in human male and female and their role in reproduction.

### 17.7.1 Male Reproductive Organ - Structure of Testes

Testes are the reproductive glands of the male that are oval shaped organs which lie outside the abdominal cavity of a man in a sac like structure called **scrotum**. Now we shall study the various cells which are present in the testes.

Each testes is covered with a layer of fibrous tissue called **tunica albuginea**. Many septa from this layer divide the testes into pyramidal lobules, in which lie seminiferous tubules, cells of Sertoli, and the Leydig cells (interstitial cells).

The process of **spermatogenesis** takes place in the **seminiferous tubules**. The **Sertoli cells** are the supporting cells and provide **nutrients** to the developing sperms. The **Leydig cells** are polyhedral in shape and

lie between the seminiferous tubules and secrete **testosterone**. It initiates the process of **spermatogenesis**.

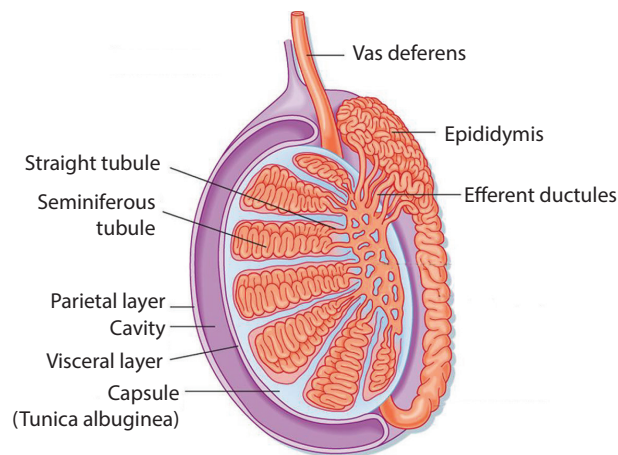

Figure 17.13 L.S of human testes

### 17.7.2. Female Reproductive Organ - Structure of Ovary

The ovaries are located on either side of the lower abdomen composed of two almond shaped bodies, each lying near the lateral end of fallopian tube. Each ovary is a compact structure consisting of an outer cortex and an inner medulla. The cortex is composed of a network of connective tissue called as stroma and is lined by the **germinal epithelium**. The epithelial cells called the **granulosa cells** surround each ovum in the ovary together forming the primary follicle. As the egg grows larger, the follicle also enlarges and gets filled with the fluid and is called the **Graafian follicle**.

#### Info bits

The number of primordial follicles in new born female child ranges over 7 million and during reproductive period (at puberty) the number is around 60,000 to 70,000. During a woman's lifetime, she will only ovulate 300 to 400 of the 1-2 million eggs, she was initially born with. On the other side, men will produce over 500 billion sperms in their lifetime.

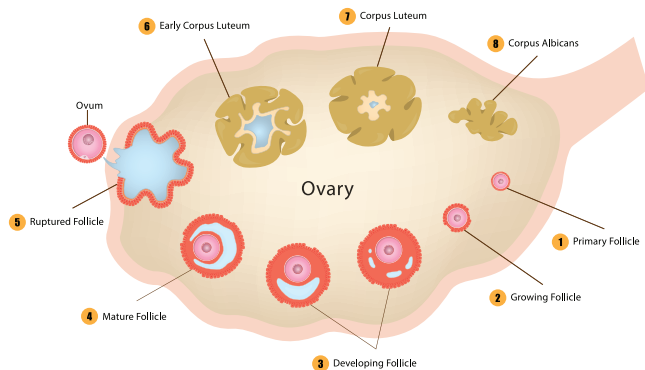

Figure 17.14 L.S of human ovary

## 17.8 Gametogenesis

The formation of the sperm in male and the ovum in female is called **gametogenesis**. It involves **spermatogenesis** (formation of spermatozoa) and **oogenesis** (the formation of ova). Gametes with **haploid cells** are produced through gametogenesis.

### 17.8.1 Structure of Human Sperm

The spermatozoan consists of head, a middle piece and tail. The **sperm head** is elongated and formed by the condensation of nucleus. The anterior portion has a cap

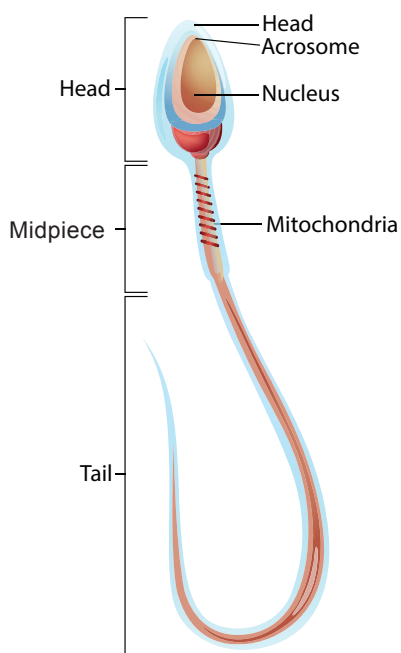

Figure 17.15 Structure of sperm

like structure called **acrosome**. It contains **hyaluronidase** an enzyme that helps the sperm to enter the ovum during fertilization. A short neck connects the head and **middle piece** which comprises the **centrioles**. The middle piece contains the **mitochondria** which provides energy for the movement of tail. It brings about **sperm motility** which is essential for fertilization.

### 17.8.2 Structure of Human Ovum

The mature ovum or egg is spherical in shape. The ovum is almost free of yolk. It contains abundant cytoplasm and the nucleus. The ovum is surrounded by three membranes. The **plasma membrane** is surrounded by inner thin **zona pellucida** and an outer thick **corona radiata**. The corona radiata is formed of **follicle cells**. The membrane forming the surface layer of the ovum is called **vitelline membrane**. The fluid-filled space between zona pellucida and the surface of the egg is called **perivitelline space**.

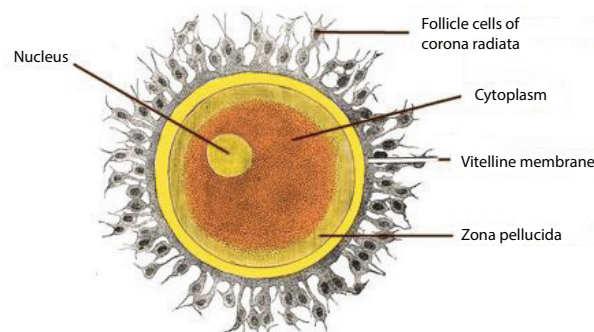

Figure 17.16 Structure of ovum

### Puberty

The reproductive system in both males and females becomes functional and an increase in sex hormone production resulting in puberty. This phenomenon tends to start earlier in females than in males. Generally boys attain puberty between the age of 13 to 14 years, while girls reach puberty between 11 to 13 years. In male, the onset of puberty is triggered by the secretion of the hormone testosterone in the testes, in female the secretion of estrogens and progesterone from

the ovary. The secretion of both male and female hormones are under the control of the pituitary gonadotropins luteinizing hormone (LH) and follicle stimulating hormone (FSH).

### 17.9 Menstrual Cycle-Process of Ovulation

The cyclic events that take place in a rhythmic fashion during the reproductive period of a woman's life is called menstrual cycle. In human females the menstrual cycle starts at the age of 11-13 years which marks the onset of puberty and is called **menarche**, and ceases around 48-50 years of age and this stage is termed **menopause**. The reproductive period is marked by characteristic events repeated almost every month in physiologically normal women (28 days with minor variation) in the form of a menstrual flow. The menstrual cycle consists of 4 phases

1. Menstrual or Destructive Phase
2. Follicular or Proliferative Phase

3. Ovulatory Phase
4. Luteal or Secretory Phase

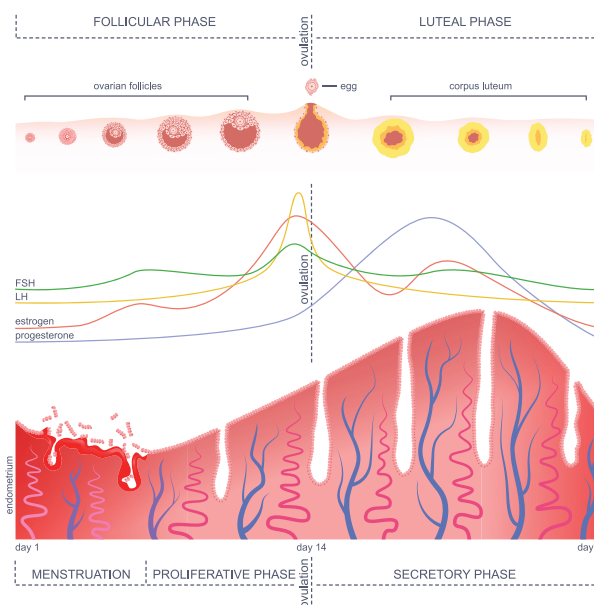

Figure 17.17 Menstrual cycle

These phases show simultaneous synchrony of events in both ovary and uterus. Changes in the ovary and the uterus are

Table 17.1 Events of Menstrual Cycle and the Role of Hormones

Phase	Days	Changes in Ovary	Changes in Uterus	Hormonal Changes
Menstrual phase	4-5 days	Development of primary follicles	Breakdown of uterine endometrial lining leads to bleeding	Decrease in progesterone and oestrogen
Follicular phase	6 <sup>th</sup> -13 <sup>th</sup> day	Primary follicles grow to become a fully mature Graafian follicle	Endometrium regenerates through proliferation	FSH and oestrogen increase
Ovulatory phase	14 <sup>th</sup> day	The Graafian follicle ruptures, and releases the ovum(egg)	Increase in endometrial thickness	LH peak
Luteal phase	15 <sup>th</sup> -28 <sup>th</sup> day	Emptied Graafian follicle develops into corpus luteum	Endometrium is prepared for implantation if fertilization of egg takes place, if fertilization does not occur corpus luteum degenerates, uterine wall ruptures, bleeding starts and unfertilized egg is expelled	LH and FSH decrease, Corpus luteum produces progesterone and its level increases followed by a decline, if menstrual bleeding occurs

induced by the pituitary hormones (LH and FSH) and ovarian hormones (estrogen and progesterone).

**Info bit**

Menstruation is a periodical phenomenon that continues from puberty to menopause. This will happen if the released ovum is not fertilized by the sperm. Lack of menstruation generally indicates pregnancy.

**17.10 Fertilization to Foetal Development**

**Fertilization**

Fertilization in human is internal and occurs in the oviduct of the female genital tract. It takes place usually in the ampulla of the fallopian tube. An oocyte is alive for about 24 hours after it is released from the follicle. Fertilisation must take place within 24 hours. The sperm enters into the ovum and fuses with it, resulting in the formation of a 'zygote'. This process is called fertilization. The zygote is a **fertilized ovum**.

**Cleavage and Formation of Blastula**

The first cleavage takes place about 30 hours after fertilization. Cleavage is a series of rapid mitotic divisions of the zygote to form many celled blastula (**Blastocyst**) which comprises an outer layer of smaller cells and inner mass of larger cells.

**Implantation**

The blastocyst (fertilized egg) reaches the uterus and gets implanted in the uterus. The process of attachment of the blastocyst to the uterine wall (**endometrium**) is called implantation. The fertilized egg becomes implanted in about 6 to 7 days after fertilization.

**Gastrulation**

The transformation of blastula into gastrula and the formation of **primary germ**

**Info bits**

Normally one egg matures in the ovary each month. Ovulation is the rupture of the follicle releasing the egg or ovum. The uterus prepares itself to receive the fertilized egg every month. The uterine lining becomes thick and spongy for implantation of the fertilized egg.

**Events leading to when fertilization occurs and does not occur**

If fertilization takes place the corpus luteum persists, continues to secrete progesterone maintains the thickened state of uterine wall and prevents maturation of another follicle till the end of pregnancy

If fertilization does not occur, corpus luteum degenerates, the egg disintegrates and the uterine lining slowly breaks, discharged as blood and mucus leading to menstrual events.

layers (ectoderm, mesoderm and endoderm) by rearrangement of the cells is called gastrulation. This takes place after the process of implantation.

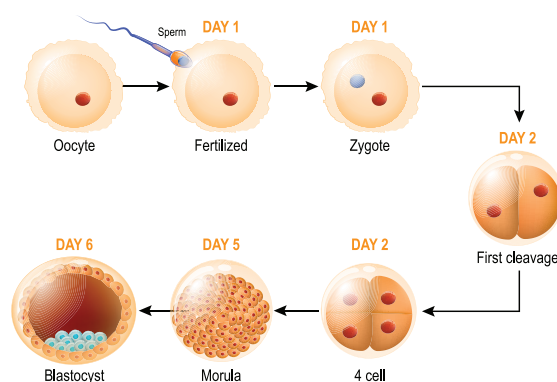

**Figure 17.18** Developmental stages of zygote from cleavage to blastocyst formation

**Organogenesis**

The establishment of the germ layers namely ectoderm, mesoderm and endoderm initiates the final phase of embryonic

development. During organogenesis the various organs of the foetus are established from the different germ layers attaining a functional state.

### Formation of Placenta

The placenta is a disc shaped structure attached to the uterine wall and is a temporary association between the developing embryo and maternal tissues. It allows the exchange of food materials, diffusion of oxygen, excretion of nitrogenous wastes and elimination of carbon dioxide. A cord containing blood vessels that connects the placenta with the foetus is called the **umbilical cord**.

### Pregnancy (Gestation)

It is the time period during which the embryo attains its development in the uterus. Normally gestation period of human last for about 280 days. During pregnancy the uterus expands upto 500 times of its normal size.

### Parturition (Child Birth)

Parturition is the **expulsion** of young one from the mother's uterus at the end of gestation. **Oxytocin** from the posterior pituitary stimulates the **uterine contractions** and provides force to expel the baby from the uterus, causing birth.



Sometimes ovaries releases two eggs and each is fertilised by a different sperm, resulting in **Non-Identical Twins (Fraternal Twins)**. If single egg is fertilised and then divides into two foetus, **Identical Twins** develop.

### Lactation

The process of milk production after child birth from mammary glands of the mother is called lactation. The first fluid which is released from the mammary gland after child birth is called as **colostrum**. Milk production from alveoli of mammary glands is stimulated by **prolactin** secreted from the anterior pituitary.

The **ejection of milk** is stimulated by posterior pituitary hormone **oxytocin**.

#### Info bits

The milk produced from the breast during the first 2 to 3 days after child birth is called colostrum. It contains immune substances and provides immunity to the new born which is essential for the body.

### 17.11. Reproductive Health

According to World Health Organization (WHO) reproductive health means a total well being in all aspects of reproduction, ability to reproduce and regulate fertility, women's ability to undergo pregnancy and safe child birth, maternal and infant survival and well being.

Several measures were undertaken by the government to improve the reproductive health of the people by launching **National Health Programmes** such as the

- i. Family Welfare Programme
- ii. Reproductive and Child Health Care (RCH) Programme

**Family welfare programme:** The National Family Welfare Programme is a comprehensive scheme which includes:

1. Maternal and child health care (MCH)
2. Immunization of mothers, infants and children.
3. Nutritional supplement to pregnant women and children.
4. Contraception with health education, to motivate couples to accept contraceptive methods and to have small family norms, which improve economic status, living status and the quality of life.

**Reproductive and Child Health Care (RCH) Programme:** It has integrated all services which include

- Pregnancy and child birth
- Postnatal care of the mother and child

- Importance of breast feeding
- Prevention of reproductive tract infections and sexually transmitted diseases.

## 17.12 Population Explosion and Family Planning

Population explosion defined as the sudden and rapid rise in the size of population, especially human population. Realizing the dangers inherent in population growth, the Government of India has taken several measures to check population growth and introduced family planning. **India** has been one of the **first country in the world to launch the nation wide family planning programme in 1952.**

Family planning is a way of living that is adopted voluntarily by couples on the basis of knowledge and responsible decisions to promote the health and welfare of the family group and society. The WHO (World Health Organisation) has also stressed the importance of family planning as global strategy health for all.



The inverted red triangle is a symbol of family planning in India for family welfare. It is displayed prominently at all hospitals, primary health clinics and family welfare centres where any help or advice about family planning is available free of cost. The symbol is displayed along with a slogan *Small Family, Happy Family.*

### 17.12.1. Contraception

Contraception is one of the best **birth control measures.** A number of techniques or methods have been developed to prevent pregnancies in women. The devices used for contraception are called **contraceptive devices.** Common contraceptive methods used to prevent pregnancy are discussed here.

1. Barrier methods
2. Hormonal methods
3. Intra-Uterine Devices (IUDs)
4. Surgical methods

#### Barrier Methods

This method prevents sperms from meeting the ovum. Its entry into the female reproductive tract is prevented by barrier.

(a) **Condom:** Condom prevents deposition of sperms in the vagina. Condoms are made of thin rubber or latex sheath. Condom also protect against sexually transmitted diseases (STD) like syphilis, AIDS.

(b) **Diaphragm (Cervical cap):** Vaginal diaphragm fitting into the vagina or a cervical cap fitting over the cervix. This prevents the entry of sperms into the uterus.

#### Hormonal Methods

Hormonal preparations are in the form of **pills** or **tablets** (contraceptive pills). These hormones stop (**interfere with ovulation**) the release of egg from the ovary.

#### Intra-Uterine Devices (IUDs)

The intrauterine device (IUD) are contraceptive devices inserted into the uterus. There are two synthetic devices commonly used in India are **Lippe's Loop** and **Copper-T** made of copper and plastic (non irritant). This can remain for a period of 3 years. This reduces the sperm fertilizing capacity and prevents implantation. This also helps to give adequate time interval between pregnancies.

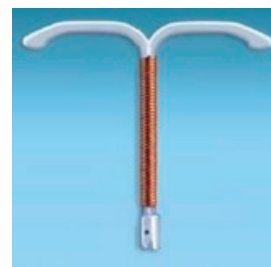

Figure 17.19  
Copper-T

#### Surgical Methods

Surgical contraception or sterilization techniques are terminal methods to prevent any pregnancy. This procedure in males is **vasectomy (ligation of vas deferens)** and in females it is

tubectomy (ligation of fallopian tube). These are methods of permanent birth control.

### 17.13 Urinary Tract Infection (UTI)

Many diseases affect both women and men, but a few diseases occur at a higher frequency in woman. Woman are susceptible to UTI from the bacteria that are present on skin, rectum or vagina. This will enter the urethra, before moving upwards. The types of UTI are:

#### 1. Cystitis or Bladder infection

Bacteria lodged in the urinary bladder thrive and multiply leading to **inflammation**. It is most common in the age group of 20 to 50.

#### 2. Kidney Infection

The bacteria can travel from the urinary bladder and upward to ureter and **affect one or both the kidneys**. It also **infects the blood stream** and leads to serious life-threatening complications.

#### 3. Asymptomatic Bacteriuria

The bacteria present in the urinary bladder which may not show any symptoms.

### 17.14 Personal Hygiene

Hygiene is the practice of healthy living and personal cleanliness. Personal hygiene is caring of one's own body and health. Social hygiene is proper care of the surrounding environment. The main aspect of hygiene are body hygiene, food hygiene, sanitary hygiene and hygienic environment.

#### 17.14.1 Body Hygiene

Washing is vital to all age group of people which maintains our personal hygiene. A daily bath regularly keeps skin clean and free of germs. Hair should be kept clean by frequent washing. Mouth wash should be done after every meal. We should wash our hands many times during the day.

Cloth towels used to dry our hands or body should be dried after each use and laundered regularly. Clothes, handkerchief, undergarments and socks should be washed daily. Washing prevents body odour, infections and skin irritation.

#### 17.14.2 Toilet Hygiene

The toilet has a lot to do with personal hygiene and general health as it is a place that cannot be avoided and used regularly. Parents should guide and practice their children on how to use the toilets at home, in schools and other public places so that it will protect the children from various contagious infections and diseases. The following measures can ensure toilet hygiene

1. The floors of the toilet should be maintained clean and dry. This helps to reduce the bad odour and also infection.
2. Toilet flush handles, door knobs, faucets, paper towel dispensers, light switches and walls should be cleaned with disinfectants to kill harmful germs and bacteria.
3. Hands should be washed thoroughly with soap before and after toilet use.

#### 17.14.3 Menstrual and Napkin Hygiene

Women's health depends upon the level of cleanliness to keep them free from skin and genitourinary tract infection.

##### Menstrual hygiene

Maintaining menstrual hygiene is important for the overall health of women. The basic menstrual hygiene ways are

1. Sanitary pads should be changed regularly, to avoid infections due to microbes from vagina and sweat from genitals.
2. Use of warm water to clean genitals helps to get rid of menstrual cramps.

- Wearing loose clothing rather than tight fitting clothes will ensure the airflow around the genitals and prevent sweating.

### More to Know

Every year May 28 is observed as Menstrual Hygiene day to make girls and women aware of maintaining menstrual hygiene and importance of menstrual hygiene for good health. By way of awareness through films, discussions and campaigns menstrual hygiene has taken quite the centre stage in recent days.

### Napkin hygiene

The parents and teachers are to create awareness among the school girls about the use of napkins and their proper disposal. Girls should be educated in the following ways

- The sanitary pad and tampons should be wrapped properly and discarded because they can spread infections.
- Sanitary pad or tampon should not be flushed down the toilet.
- Napkin incinerators are to be used properly for disposal of used napkins.

### Info bits

The menstrual hygiene scheme to provide subsidized sanitary napkins was launched by the Health ministry in 2011.

In Tamil Nadu, UNICEF has developed an affordable incinerator that uses firewood to handle sanitary napkin waste at schools and special wells are equipped where sanitary napkins are composted.

### Points to Remember

- ❖ Many bacteria and protozoa simply divide into two or more daughter cells by fission.
- ❖ Organisms such as hydra can regenerate if they are broken into pieces. They can also give out buds which mature into new individuals.
- ❖ Reproduction in flowering plants involves transfer of pollen grains from the anther to the stigma which is referred to as pollination. This is followed by fertilization.
- ❖ Sexual reproduction involves the fusion of two haploid gametes (male and the female gametes) to form a diploid individual (zygote).
- ❖ The formation of the sperm in male and the ovum in female is called gametogenesis. It involves spermatogenesis (formation of spermatozoa) and oogenesis (the formation of ova).
- ❖ The cyclic events that take place in a rhythmic manner during the reproductive period of a woman's life is called menstrual cycle.
- ❖ The process of attachment of the blastocyst to the uterine wall (endometrium) is called implantation.
- ❖ The placenta is a temporary association between the developing embryo and maternal tissues.
- ❖ Parturition is the expulsion of young one from the mother's uterus.
- ❖ Contraception is one of the best birth control measures. The devices used for contraception are called contraceptive devices.



## TEXTBOOK EVALUATION



### I. Choose the correct answer

- The plant which propagates with the help of its leaves is \_\_\_\_\_ .  
 a) Onion                                      b) Neem  
 c) Ginger                                      d) *Bryophyllum*
- Asexual reproduction takes place through budding in \_\_\_\_\_ .  
 a) *Amoeba*                                      b) Yeast  
 c) *Plasmodium*                                      d) Bacteria



3. Syngamy results in the formation of \_\_\_\_\_ .  
 a) Zoospores                      b) Conidia  
 c) Zygote                              d) Chlamydo spores
4. The essential parts of a flower are \_\_\_\_\_ .  
 a) Calyx and Corolla  
 b) Calyx and Androecium  
 c) Corolla and Gynoecium  
 d) Androecium and Gynoecium
5. Anemophilous flowers have \_\_\_\_\_ .  
 a) Sessile stigma  
 b) Small smooth stigma  
 c) Colored flower  
 d) Large feathery stigma
6. Male gametes in angiosperms are formed by the division of \_\_\_\_\_ .  
 a) Generative cell  
 b) Vegetative cell  
 c) Microspore mother cell  
 d) Microspore
7. What is true of gametes?  
 a) They are diploid  
 b) They give rise to gonads  
 c) They produce hormones  
 d) They are formed from gonads
8. A single highly coiled tube where sperms are stored, get concentrated and mature is known as  
 a) Epididymis      b) Vasa efferentia  
 c) Vas deferens      d) Seminiferous tubules
9. The large elongated cells that provide nutrition to developing sperms are  
 a) Primary germ cells      b) Sertoli cells  
 c) Leydig cells                      d) Spermatogonia
10. Estrogen is secreted by  
 a) Anterior pituitary      b) Primary follicle  
 c) Graafian follicle              d) Corpus luteum

11. Which one of the following is an IUCD?  
 a) Copper – T                      b) Oral pills  
 c) Diaphragm                      d) Tubectomy

**II. Fill in the blanks**

1. The embryo sac in a typical dicot at the time of fertilization is \_\_\_\_\_ .
2. After fertilization the ovary develops into \_\_\_\_\_ .
3. *Planaria* reproduces asexually by \_\_\_\_\_ .
4. Fertilization is \_\_\_\_\_ in humans
5. The implantation of the embryo occurs at about \_\_\_\_\_ day of fertilization
6. \_\_\_\_\_ is the first secretion from the mammary gland after child birth
7. Prolactin is a hormone produced by \_\_\_\_\_ .

**III. (a) Match the following**

Column 1	Column 2
Fission	Spirogyra
Budding	Amoeba
Fragmentation	Yeast

**III. (b) Match the following terms with their respective meanings**

- a) Parturition - 1) Duration between pregnancy and birth
- b) Gestation - 2) Attachment of zygote to endometrium
- c) Ovulation - 3) Delivery of baby from uterus
- d) Implantation - 4) Release of egg from Graafian follicle

**IV. State whether the following statements are True or False. Correct the false statement**

1. Stalk of the ovule is called pedicle.
2. Seeds are the product of asexual reproduction.

3. Yeast reproduces asexually by means of multiple fission.
4. The part of the pistil which serves as a receptive structure for the pollen is called as style.
5. Insect pollinated flowers are characterized by dry and smooth pollen.
6. Sex organs produce gametes which are diploid.
7. LH is secreted by the posterior pituitary.
8. Menstrual cycle ceases during pregnancy.
9. Surgical methods of contraception prevent gamete formation.
10. The increased level of estrogen and progesterone is responsible for menstruation.

**V. Answer in a word or sentence**

1. If one pollen grain produces two male gametes, how many pollen grains are needed to fertilize 10 ovules?
2. In which part of the flower germination of pollen grains takes place?
3. Name two organisms which reproduces through budding.
4. Mention the function of endosperm.
5. Name the hormone responsible for the vigorous contractions of the uterine muscles.
6. What is the enzyme present in acrosome of sperm?
7. When is World Menstrual Hygiene Day observed?
8. What is the need for contraception ?
9. Name the part of the human female reproductive system where the following occurs.
  - a. Fertilization
  - b. Implantation

**VI. Short answer question**

1. What will happen if you cut planaria into small fragments?
2. Why is vegetative propagation practiced for growing some type of plants?
3. How does binary fission differ from multiple fission?

4. Define triple fusion.
5. Write the characteristics of insect pollinated flowers.
6. Name the secondary sex organs in male
7. What is colostrum? How is milk production hormonally regulated ?
8. How can menstrual hygiene be maintained during menstrual days?
9. How does developing embryo gets its nourishment inside the mother's body?
10. Identify the parts A, B, C and D

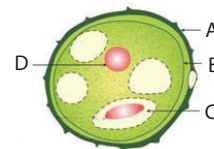

11. Write the events involved in the sexual reproduction of a flowering plant.
  - a. Discuss the first event and write the types.
  - b. Mention the advantages and the disadvantages of that event.
12. Why are the human testes located outside the abdominal cavity? Name the pouch in which they are present .
13. Luteal phase of the menstrual cycle is also called the secretory phase. Give reason.
14. Why are family planning methods not adopted by all the people of our country?

**VII. Long answer questions**

1. With a neat labelled diagram describe the parts of a typical angiospermic ovule.
2. What are the phases of menstrual cycle? Indicate the changes in the ovary and uterus.

**VIII. Higher Order Thinking Skills (HOTS)**

1. In angiosperms the pollen germinates to produce pollen tube that carries two gametes. What is the purpose of carrying two gametes when single gamete can fertilize the egg?
2. Why menstrual cycle does not take place before puberty and during pregnancy ?
3. Read the following passage and answer the questions that follow

Rahini and her parents were watching a television programme. An advertisement flashed on the screen which was promoting use of sanitary napkins. Rahini's parents suddenly changed the channel, but she objected to her parents and explained the need and importance of such advertisement.

- What is first menstruation called? When does it occur ?
- List out the napkin hygiene measures taken during menstruation ?
- Do you think that Rahini's objection towards her parents was correct? If so, Why?



### REFERENCE BOOKS

- Verma P.S and Agarwal, V.K. and Tyagi B.S, Animal Physiology, S.Chand and Company, New Delhi
- Knut Schmidt and Nielsen, Animal Physiology, Foundations of Modern Biology series

- Rastogi S.C. Essentials of Animal Physiology, 3<sup>rd</sup> Edition, Rastogi Publications, Meerut.
- Winwood R.S. and Smith J.L., Sear's Anatomy and Physiology for Nurses, 6<sup>th</sup> Edition, Edward Arnold and Jaypee Brothers.



### INTERNET RESOURCES

- <http://www.importantindia.com/10606/population-explosion-in-India/>
- <http://www.yourarticlelibrary.com/population/3-important...control-overpopulation/26950>
- <http://www.momjunction.com>pregnancy>Health>
- <https://leadership.ng/2018/04/08/toilet-hygiene>
- <https://www.boldsky.com/health/wellness/2018/world-menstrual-hygiene-day>

### Concept Map

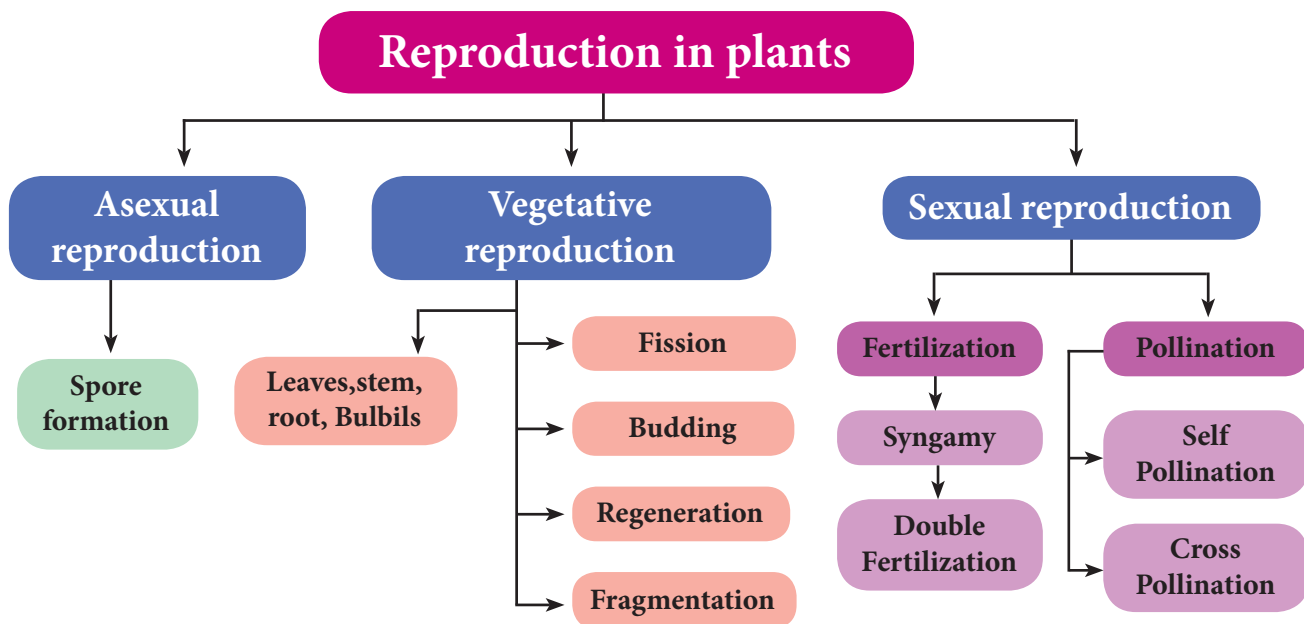

### SEXUAL REPRODUCTION IN HUMAN

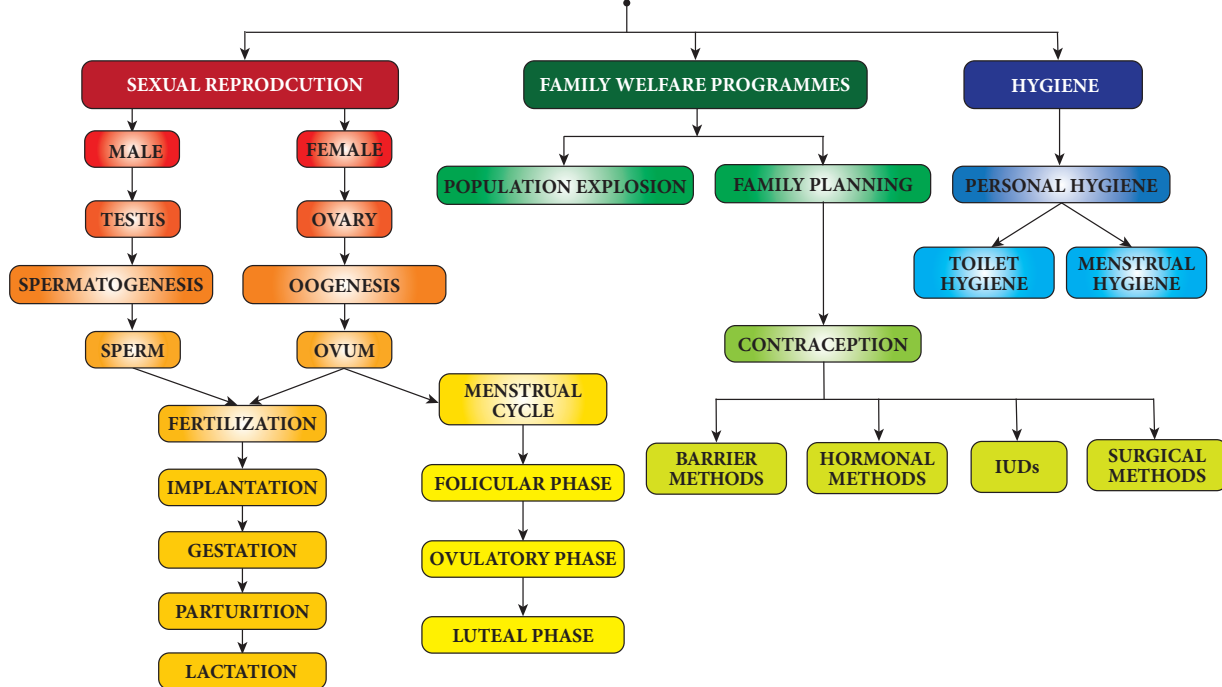

### ICT CORNER

### REPRODUCTION

**WHO HTS INFO** – This application enables the students to know about HIV tests and information. It was created by World Health Organization.

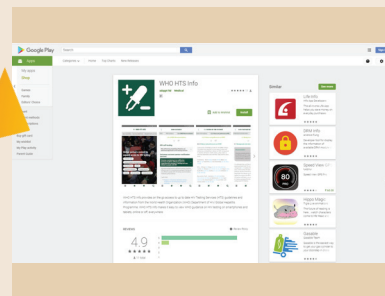

#### Steps

- You can see the moving Menu bar at the top of the home screen. The same thing can be accessed from the Menu at the left bottom.
- You can view the latest news and events about HIV by clicking the News button.
- It includes many updates and information in Testing strategies, Pre and Post test service.
- You can reach the home page from any page of the application by clicking HOME button.



Step1



Step2



Step3



Step4

Cells alive

URL : <https://play.google.com/store/apps/details?id=com.whohtsinfo>

\*Pictures are indicative only



B375\_10\_SCIENCE\_EM



## Learning Objectives



QXM9MV

At the end of this lesson the students will be able to :

- ◆ Know about Mendelian laws.
- ◆ Differentiate between phenotype and genotype.
- ◆ Understand the process of monohybrid and dihybrid cross.
- ◆ Differentiate between a chromosome, DNA and gene.
- ◆ Understand the structure of chromosome.
- ◆ Classify the chromosomes based on the position of centromere.
- ◆ Understand the structure and replication of DNA.
- ◆ Define mutation and classify the chromosomal and gene mutation.
- ◆ Identify the chromosomal abnormality of Down's syndrome.

## Introduction

“Like Begets Like” is an important and universal phenomenon of life as the living beings produce offspring of their own kind. Colour of eye, color of hair, shape of nose, type of earlobe, etc, are inheritable traits. Have you ever wondered, how do we inherit traits and characteristics from our father and mother? Some of our characteristics might have been inherited from our grandparents. How do we inherit characters from one generation to another? It is because of the genes we inherit from our parents. These genes are responsible for the physical outlook and biological functions. The branch of biology that deals with the genes, genetic variation and heredity of living organisms is called genetics.

Heredity is transmission of characters, from one generation to the next generation, while variation refers to the differences shown by the individuals of the same species and also by the offspring of the same parents. All these can happen only due to chromosomes. Now let's see what chromosomes are and how they are composed with DNA, that form the genetic material.















### 18.1 Gregor Johann Mendel - Father of Genetics

**Mendel** (1822-1884) was an Austrian monk who discovered the basic principles of heredity through his experiments. His experiments are the foundation for modern genetics. He was born in 1822 to a family of farmers in Silesian of Czechoslovakia. After finishing his high school

at the age of 18, he entered the Augustinian Monastery at Brunn as a priest. From there he went to the University of Vienna for training in physics, mathematics and natural science. Mendel returned to the monastery in 1854 and continued to work as a priest and teach in high school. In his leisure time he started his famous experiments on the garden pea plant. He conducted his experiments in the monastery for about nine years from 1856 to 1865. He had worked on nearly 10000 pea plants of 34 different varieties. Mendel noted that they differ from one another in many ways.

Thus Mendel had chosen 7 pairs of contrasting characters for his study as shown in the table.

**Table 18.1** Contrasting characters of pea plant used by Mendel

Characteristic studied	Dominant character	Recessive character
Stem length	Long 	Short 
Flower Position	Axillary 	Terminal 
Flower colour	Blue 	White 
Pod shape	Inflated 	Constricted 
Pod colour	Green 	Yellow 
Seed shape	Round 	Wrinkled 
Seed colour	Yellow 	Green 

### Reasons for Mendel's success

He chose the pea plant as it was advantageous for experimental work in many aspects

1. It is naturally self-pollinating and so is very easy to raise pure breeding individuals.
2. It has a short life span as it is an annual and so it was possible to follow several generations.
3. It is easy to cross-pollinate.
4. It has deeply defined contrasting characters.
5. The flowers are bisexual.

## 18.2 Monohybrid Cross – Inheritance of One Gene

Crosses involving **inheritance of only one pair of contrasting characters** are called monohybrid crosses. For example it is a cross between two forms of a single trait like a cross between tall and dwarf plant.

### Mendel's Explanation of Monohybrid Cross

**Parental generation:** Pure breeding tall plant and a pure breeding dwarf plant.

**F<sub>1</sub> generation:** Plants raised from the seeds of pure breeding parental cross in F<sub>1</sub> generation were tall and monohybrids.

**F<sub>2</sub> generation:** Selfing of the F<sub>1</sub> monohybrids resulted in tall and dwarf plants respectively in the ratio of 3:1. The actual number of tall and dwarf plants obtained by Mendel was 787 tall and 277 dwarf. External expression of a particular trait is known as phenotype. So the phenotypic ratio is 3:1.

In the F<sub>2</sub> generation 3 different types were obtained:

Tall Homozygous – TT (Pure) – 1

Tall Heterozygous – Tt – 2

Dwarf Homozygous – tt – 1

So the **genotypic ratio 1:2:1**. A genotype is the genetic expression of an organism

### Mendel's Interpretation on Monohybrid cross

Based on these observations it was confirmed by Mendel that 'factors' are passed on from one generation to another, **now referred to as genes**. Tallness and Dwarfness are determined by a pair of contrasting factors, tall plant possess a pair of factors (represented by T- taking the first letter of the dominant character) and a plant is dwarf because it possess factors for dwarfness (represented as t- recessive character). These factors occur

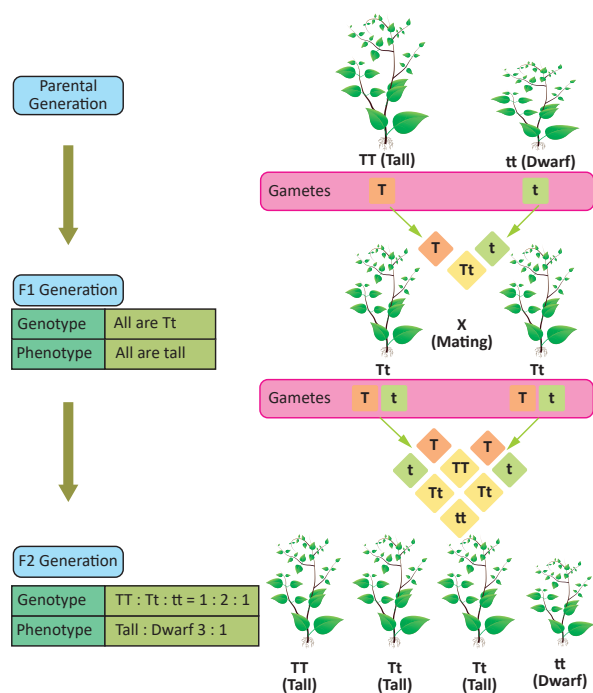

Figure 18.1 Monohybrid cross

in pairs and may be alike as in pure breeding tall plants ( $TT$ ) and dwarf plants ( $tt$ ). This is referred to as **homozygous**. If they are unlike ( $Tt$ ) they are referred to as **heterozygous**.

- Two factors making up a pair of contrasting characters are called **alleles**. Phenotypic expression of alleles are called **allelomorphs**. One member of each pair is contributed by one parent.
- When two factors for alternative expression of a trait are brought together by fertilization. The **character which expresses itself** is called **dominant (Tallness)** condition and that which is **masked** is called **recessive condition (Dwarfness)**.
- The factors are always pure and when gametes are formed, the unit factors segregate so that each gamete gets one of the two alternative factors. It means that factors for tallness( $T$ ) and dwarfness( $t$ ) are separate entities and in a gamete either  $T$  or  $t$  is present. When  $F_1$  hybrids are self crossed the two entities separate and then unite independently, forming tall and dwarf plants.

### Info bits

Punnett square is a checker board form devised by a British geneticist R.C.Punnett for study of genetics. It is a graphical representation to calculate the probability of all possible genotypes of offsprings in a genetic cross.

### 18.3 Dihybrid Cross- Inheritance Two Genes and Law of Independent Assortment

Dihybrid cross involves the **inheritance of two pairs of contrasting characteristics** (or contrasting traits) at the same time. The two pairs of contrasting characteristics chosen by Mendel were **shape and colour of seeds: round-yellow seeds and wrinkled-green seeds**.

Mendel crossed pea plants having round-yellow seeds with pea plants having wrinkled-green seeds. Mendel made the following observations:

- Mendel first crossed pure breeding pea plants having round-yellow seeds with pure breeding pea plants having wrinkled-green seeds and found that only round-yellow seeds were produced in the first generation ( $F_1$ ). No wrinkled-green seeds were obtained in the  $F_1$  generation. From this it was concluded that **round shape and yellow colour of the seeds were dominant traits over the wrinkled shape and green color of the seeds**.
- When the hybrids of  $F_1$  generation pea plants having round-yellow seeds were cross-bred by self pollination, then four types of seeds having different combinations of shape and color were obtained in second generation or  $F_2$  generation. They were

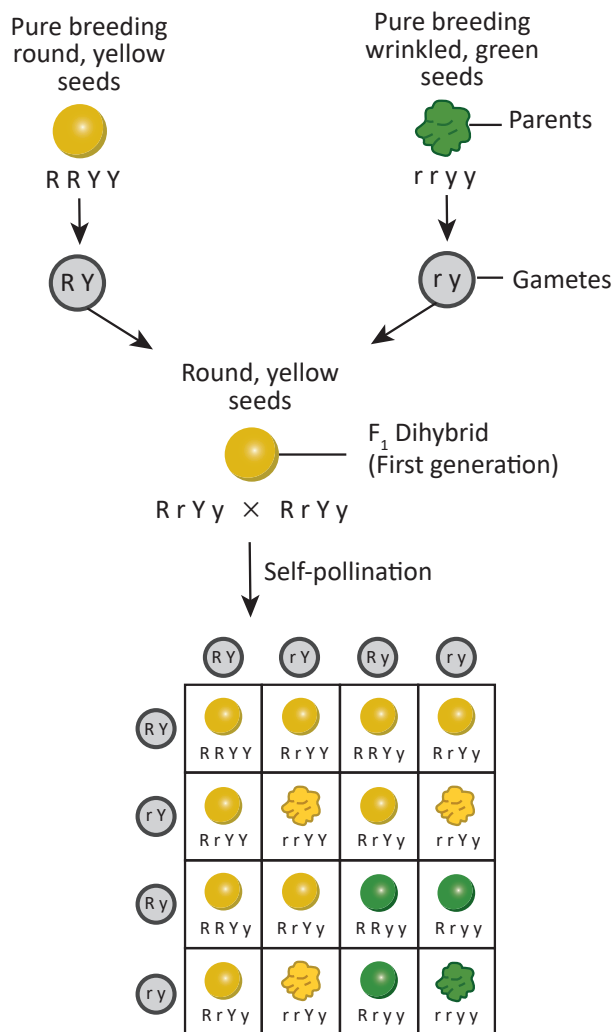

Phenotypic ratio of F<sub>2</sub> generation - 9:3:3:1

Round, Yellow - 9    Wrinkled, Yellow - 3  
Round, Green - 3    Wrinkled, Green - 1

Figure 18.2 Dihybrid Cross

round yellow, round-green, wrinkled yellow and wrinkled-green seeds.

The ratio of each phenotype (or appearance) of seeds in the F<sub>2</sub> generation is 9:3:3:1. This is known as the **Dihybrid ratio**.

From the above results it can be concluded that the factors for each character or trait remain independent and maintain their identity in the gametes. The factors are independent to each other and pass to the offsprings (through gametes).

**Results of a Dihybrid Cross:**

Mendel got the following results from his dihybrid cross

- Four Types of Plants:** A dihybrid cross produced four types of F<sub>2</sub> offsprings in the ratio of 9 with two dominant traits, 3 with one dominant trait and one recessive trait, 3 with another dominant trait and another recessive trait and 1 with two recessive traits.
- New Combination:** Two new combinations of traits with round green and wrinkled yellow had appeared in the dihybrid cross (F<sub>2</sub> generation).

**18.4 Mendel's Laws**

Based on his experiments of monohybrid and dihybrid cross, Mendel proposed three important laws which are now called as Mendel's **Laws of Heredity**.

• **Law of Dominance:**

“When two homozygous individuals with one or more sets of contrasting characters are crossed, the characters that appear in the F<sub>1</sub> hybrid are dominant and those that do not appear in F<sub>1</sub> are recessive characters”.

• **Law of Segregation or Law of purity of gametes:**

“When a pair of contrasting factors are brought together in a F<sub>1</sub> hybrid. The two factors of the allelic pair remain together without mixing and when gametes are formed, the two separate out, so that only one enters each gamete.”

• **Law of independent assortment:**

“In case of inheritance of two or more pairs of characters simultaneously, the



factors or genes of one pair assort out independently of the other pair.”

### More to Know

T.H. Morgan was awarded Nobel Prize in 1933 for determining the role of chromosomes in heredity.

## 18.5 Chromosomes, DNA and Genes

The human body is made up of million cells. The nucleus of each cell contains thin thread like structures called **chromosomes**. The term ‘chromosomes’ was first coined by **Waldeyer** in 1888. The chromosomes are the carrier of genetic material which contain the heredity information.

The chromosomes are highly condensed coiled chromatin fibres packed with the **DNA** (Deoxyribonucleic acid) that forms the genetic material. **Genes** are segments of DNA, which are responsible for the inheritance of a particular phenotypic character. Each gene is present at a **specific position** on a chromosome called its **locus**. During cell division, the genetic information present in the genes are passed from one generation to another.

### 18.5.1 Structure of a Chromosome

The chromosomes are thin, long and thread like structures consisting of two identical strands called sister chromatids. They are held together by the centromere. Each **chromatid** is made up of spirally coiled thin structure called **chromonema**. The chromonema has number of bead-like structures along its length which are called **chromomeres**. The chromosomes are made up of DNA, RNA, chromosomal proteins (histones and non-histones) and certain metallic ions. These proteins provide structural support to the chromosome .

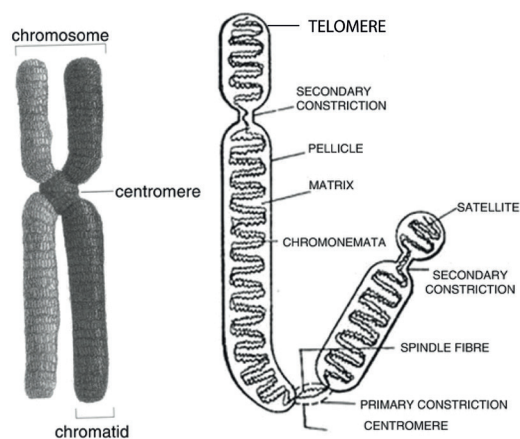

Figure 18.3 Structure of chromosome

A chromosome consists of the following regions

**Primary constriction:** The two arms of a chromosome meet at a point called **primary constriction** or **centromere**. The centromere is the region where spindle fibres attach to the chromosomes during cell division.

**Secondary constriction:** Some chromosomes possess secondary constriction at any point of the chromosome. They are known as the nuclear zone or **nucleolar organizer** (formation of nucleolus in the nucleus).

**Telomere:** The **end of the chromosome** is called telomere. Each extremity of the chromosome has a polarity and prevents it from joining the adjacent chromosome. It maintains and provides **stability to the chromosomes**.

**Satellite:** Some of the chromosomes have an elongated **knob-like appendage** at one end of the chromosome known as satellite. The chromosomes with satellites are called as the **sat-chromosomes**.



**Telomeres act as aging clock in every cell.**

Telomeres are protective sequences of nucleotides found in chromosomes. As a cell divides every time, they become shorter. Telomeres get too short to do their job, causing our cells to age.

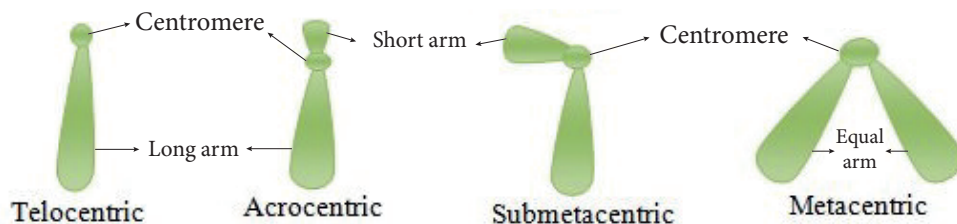

Figure 18.4 Types of chromosomes based on position of centromere

### 18.5.2 Types of Chromosomes based on the position of Centromere

Based on the position of centromere, the chromosomes are classified as **Telocentric**, **Acrocentric**, **Submetacentric** and **Metacentric**

- 1. Telocentric**– The centromere is found on the proximal end. They are rod shaped chromosomes.
- 2. Acrocentric** – The centromere is found at the one end with a short arm and a long arm. They are also rod-shaped chromosomes.
- 3. Submetacentric** – The centromere is found near the centre of the chromosome. Thus forming two unequal arms. They are J shaped or L shaped chromosomes.
- 4. Metacentric** – The centromere occurs in the centre of the chromosome and form two equal arms. They are V shaped chromosomes

### 18.5.3 Types of Chromosomes based on function

The eukaryotic chromosomes are classified into **autosomes** and **allosomes**.

Autosomes contain genes that determine the somatic (body) characters. Male and female have equal number of autosomes.

Allosomes are chromosomes which are responsible for determining the sex of an individual. They are also called as **sex chromosomes** or **hetero-chromosomes**. There are two types of sex chromosomes, X and Y- chromosomes. Human male have one X chromosome and one Y chromosome and human female have two X chromosomes.

### 18.5.4 Karyotype

The number of chromosomes in any living organism (animal or plant) is constant. In human, each cell normally contains **23 pairs** of chromosomes. Out of which 22 pairs are autosomes and the 23<sup>rd</sup> pair is the allosome or sex chromosome.

In the body cells of sexually reproducing organisms, the chromosomes generally occur in pairs. This condition is called **diploid (2n)**. The gametes produced by the organisms contain a single set of chromosomes. Hence, the gametes are said to be **haploid (n)**.

Karyotype is the **number, size and shape of chromosomes** in the cell nucleus of an organism. **Idiogram** is the diagrammatic representation of karyotype of a species. It consists of all the metaphasic chromosomes arranged in homologous pairs according to decreasing length, thickness, position of centromere, shape etc., with the sex chromosomes placed at the end.

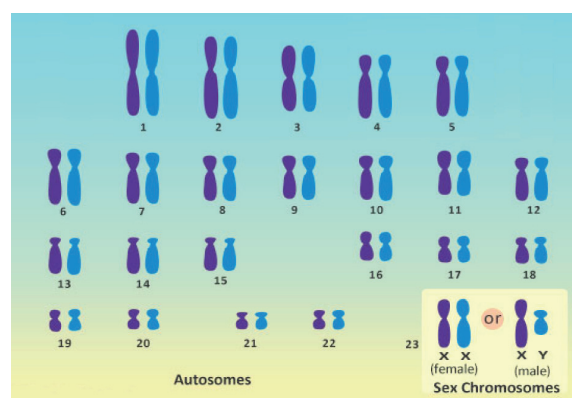

Figure 18.5 Normal human karyotype

### 18.6 Structure of DNA

DNA is the hereditary material as it contains the genetic information. It is the most important constituent of a chromosome. The most widely

accepted model of DNA is the double helical structure of **James Watson and Francis Crick**. They proposed the **three-dimensional model of DNA** on the basis of X-ray diffraction studies of DNA obtained by Rosalind Franklin and Maurice Wilkins. In appreciation of their discoveries on the molecular structure of nucleic acids Watson, Crick and Wilkins were awarded Nobel prize for Medicine in 1962.



### Chemical Composition of DNA molecule

DNA is a large molecule consisting of millions of nucleotides. Hence, it is also called a **polynucleotide**. Each nucleotide consists of three components.

1. A sugar molecules – Deoxyribose sugar.
2. A nitrogenous base.

There are two types of nitrogenous bases in DNA. They are

- (a) Purines (Adenine and Guanine)
- (b) Pyrimidines (Cytosine and Thymine)

3. A phosphate group

### Nucleoside and Nucleotide

Nucleoside = Nitrogen base + Sugar

Nucleotide = Nucleoside + Phosphate

The nucleotides are formed according to the purines and pyrimidines present in them.

#### 18.6.1 Watson and Crick model of DNA

1. DNA molecule consists of two **polynucleotide** chains.
2. These chains form a **double helix** structure with two strands which run **anti-parallel** to one another.
3. **Nitrogenous bases** in the centre are linked to **sugar-phosphate** units which form the backbone of the DNA.
4. Pairing between the nitrogenous bases is very specific and is always between purine and pyrimidine linked by hydrogen bonds.
  - \* Adenine (A) links Thymine (T) with two hydrogen bonds (A = T)

- \* Cytosine (C) links Guanine (G) with three hydrogen bonds( C ≡ G)

This is called **complementary base pairing**.

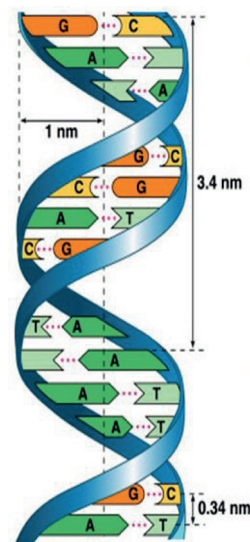

Figure 18.6 Structure of DNA

5. Hydrogen bonds between the nitrogenous bases make the DNA molecule stable.
6. Each turn of the double helix is 34 Å (3.4 nm). There are ten base pairs in a complete turn.
7. The nucleotides in a helix are joined together by phosphodiester bonds.

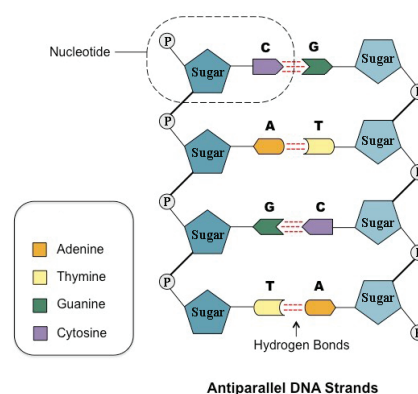

Figure 18.7 Nucleotides in a DNA

### More to Know

#### Chargaff rule of DNA base pairing

**Erwin Chargaff** states that in DNA, the proportion of adenine is always equal to that of thymine, and the proportion of guanine always equal to that of cytosine.

### 18.6.2 DNA Replication

DNA replication is one of the basic process that occurs within a cell. DNA molecule produces exact copies of its own structure during replication process. The two strands of a DNA molecule have complementary base pairs, the nucleotides of each strand provide the information needed to produce its new strand. The two resulting daughter cells contain exactly the same genetic information as the parent cell. DNA replication involves the following steps

#### Origin of replication

The specific points on the DNA, where the replication begins, is the **site of origin** of replication. The two strands open and separate at this point forming the **replication fork**.

#### Unwinding of DNA molecule

The enzyme called **helicase**, bind to the origin of replication site. Helicase separates the two strands of the DNA. The enzyme called **topoisomerase** separates the double helix above the replication fork and removes the twists formed during the unwinding process. Each of the separated DNA strands function as a template.

#### Formation of RNA primer

An RNA primer is a short segment of RNA nucleotides. The primer is synthesized

by the DNA template close to the origin of replication site.

#### Synthesis of new complementary strand from the parent strand

After the formation of RNA primer, nucleotides are added with the help of an enzyme **DNA polymerase** and a new complementary strand of DNA is formed from each of the parent strand. The synthesis is unidirectional.

In one strand, the daughter strand is synthesized as a continuous strand which is called **leading strand**. In the other strand, short segments of DNA are synthesized. This strand is called **lagging strand**. The short segments of DNA are called **Okazaki fragments**. The fragments are joined together by the enzyme, **DNA ligase**.

The replication stops when the replication fork of the two sides meet at a site called **terminus**, which is situated opposite to origin of replication site

### 18.6.3 Significance of DNA

- ◆ It is responsible for the transmission of hereditary information from one generation to next generation.

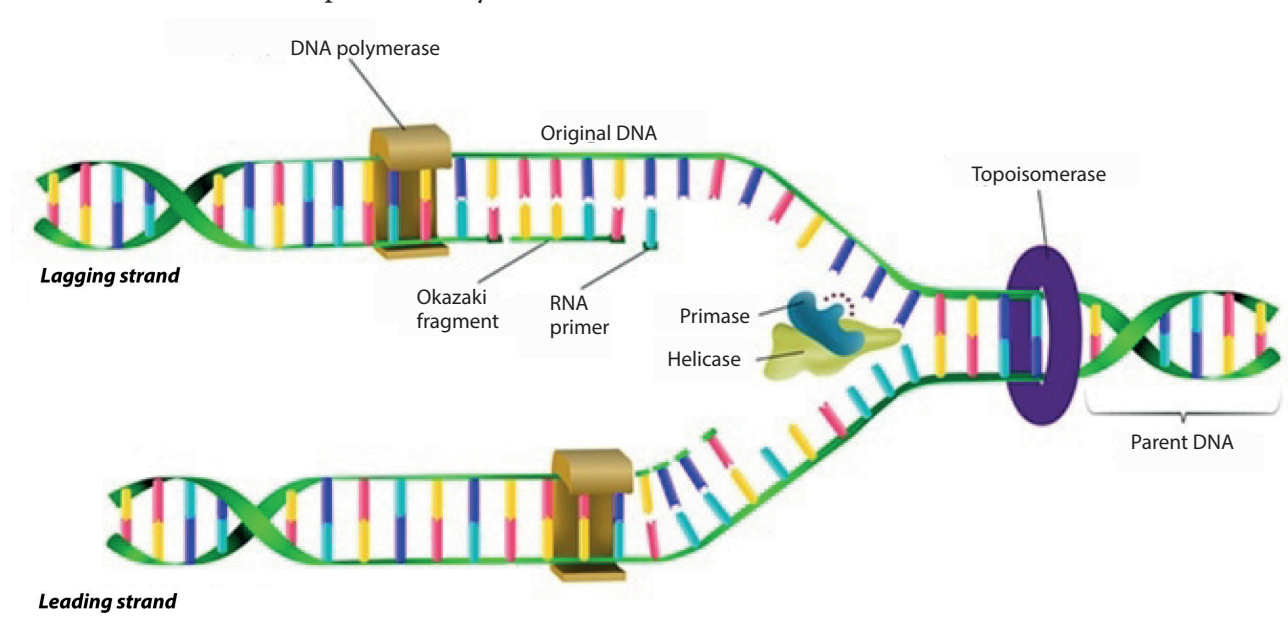

Figure 18.8 Replication of DNA

- ◆ It contains information required for the formation of proteins.
- ◆ It controls the developmental process and life activities of an organism.

## 18.7 Sex Determination

The formation of zygote into male or female sex during development is called sex determination. Sex is determined by the chromosomes of an individual.

### 18.7.1 Sex Determination in Human

Recall that human beings have 23 pairs of chromosomes out of which 22 pairs are autosomes and one pair (23<sup>rd</sup> pair) is the sex chromosome. The female gametes or the eggs formed are similar in their chromosome type (22+X). Therefore, human females are **homogametic**.

The male gametes or sperms produced are of two types. They are produced in equal proportions. The sperm bearing (22+X) chromosomes and the sperm bearing (22+Y) chromosomes. The human males are called **heterogametic**.

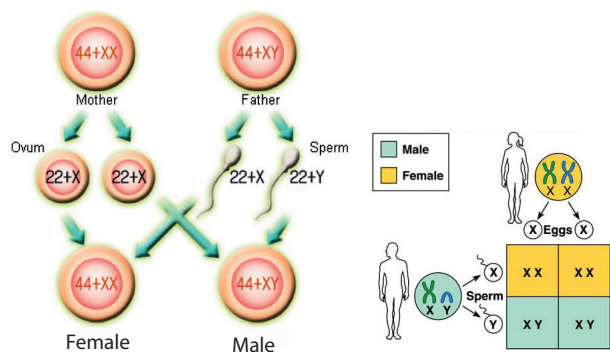

Figure 18.9 Sex determination in human

It is a chance of probability as to which category of sperm fuses with the egg. If the egg (X) is fused by the X-bearing sperm an **XX individual (female)** is produced. If the egg (X) is fused by the Y-bearing sperm an **XY individual (male)** is produced. The sperm, produced by the father, determines the sex of the child. The mother is not responsible in determining the sex of the child.

Now let's see how the chromosomes take part in this formation. Fertilization of the egg (22+X) with a sperm (22+X) will produce a female child (44+XX). while fertilization of the egg (22+X) with a sperm (22+Y) will give rise to a male child (44+XY).

### 18.7.2 Mutation

The term mutation was introduced by **Hugo De Vries** in 1901 when he observed phenotypic changes in the evening primrose plant, *Oenothera lamarckiana*. Mutation is an inheritable sudden change in the genetic material (DNA) of an organism. Mutations are classified into two main types, namely chromosomal mutation and gene mutation.

#### 1. Chromosomal mutation

The **sudden change** in the **structure** or **number of chromosomes** is called chromosomal mutation. This may result in

(i) **Changes in the structure of chromosomes:** Structural changes in the chromosomes usually occurs due to errors in cell division. Changes in the number and arrangement of genes takes place as a result of deletion, duplication, inversion and translocation in chromosomes.

(ii) **Changes in the number of chromosomes:** They involve addition or deletion in the number of chromosomes present in a cell. This is called **ploidy**. There are two types of ploidy

- Euploidy
- Aneuploidy.

**Euploidy:** It is the condition in which the individual bears **more than the usual number** of diploid (2n) chromosomes. If an individual has three haploid sets of chromosomes, the condition is called **triploidy** (3n). Triploid plants and animals are typically sterile. If it has four haploid sets of chromosomes, the condition is called **tetraploidy** (4n). Tetraploid plants are advantageous as they often result in increased fruit and flower size.

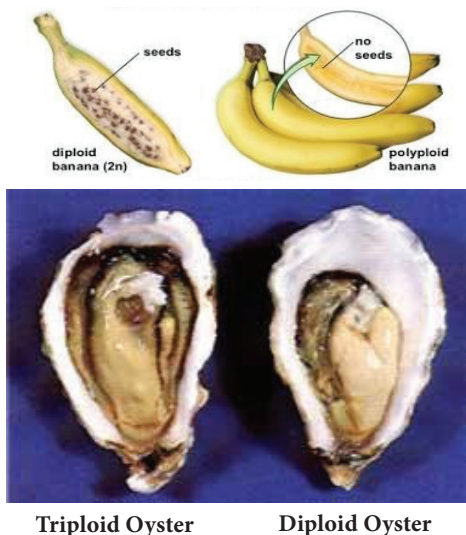

Figure 18.10 Euploidy

**Aneuploidy:** It is the **loss** or **gain** of **one** or **more chromosomes** in a set. It is of three types. **Monosomy** ( $2n-1$ ), **Trisomy** ( $2n+1$ ) and **Nullisomy** ( $2n-2$ ). In man, Down's syndrome is one of the commonly known aneuploid condition.

### Down's syndrome

This condition was first identified by a doctor named **Langdon Down** in 1866.

It is a genetic condition in which there is an extra copy of **chromosome 21 (Trisomy 21)**. It is associated with mental retardation, delayed development, behavioural problems, weak muscle tone, vision and hearing disability are some of the conditions seen in these children.

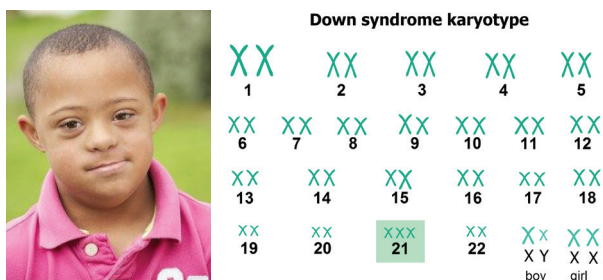

Figure 18.11 Aneuploidy

## 2. Gene or point mutation

Gene mutation is the **changes** occurring in **nucleotide sequence of a gene**. It involves substitution, deletion, insertion or inversion of a single or more than one nitrogenous base. Gene alteration results in abnormal protein formation in an organism.

**DO YOU KNOW?** Sickle cell anaemia is caused by the mutation of a single gene. Alteration in the gene brings a change in the structure of the protein part of haemoglobin molecule. Due to the change in the protein molecule, the red blood cell (RBC) that carries the haemoglobin is sickle shaped.

### Points to Remember

- ❖ Variations are quite apparent among closely related groups of organisms.
- ❖ Mendel had chosen seven pairs of distinguishing traits: flower colour, position, seed colour, shape, pod colour, pod shape, stem length.
- ❖ Every pea plant has two 'factors' which are responsible for producing a particular character or trait is called allele.
- ❖ The process of acquiring characters or traits from parents is called 'Heredity'.
- ❖ Each human cell contains 23 pairs of chromosomes. Out of these 22 pairs are called autosomes and one pair is called allosomes.
- ❖ A chromosome consists of the regions: primary constriction, centromere, secondary constriction, telomere and satellite.
- ❖ Based on the position of the centromere, the chromosomes are classified as telocentric, acrocentric, sub metacentric and metacentric chromosomes.
- ❖ Each nucleotide of DNA consists of a deoxyribose sugar, a nitrogenous base and a phosphate group. Pairing is always between a purine and a pyrimidine.
- ❖ The sperm, produced by the father, determines the sex of the child. The mother is not responsible in determining the sex of the child.
- ❖ Mutation is an inheritable change in the genetic material of an organism.



## TEXTBOOK EVALUATION



### I. Choose the correct answer

- According to Mendel alleles have the following character
  - Pair of genes
  - Responsible for character
  - Production of gametes
  - Recessive factors
- 9 : 3 : 3 : 1 ratio is due to
  - Segregation
  - Crossing over
  - Independent assortment
  - Recessiveness
- The region of the chromosome where the spindle fibres get attached during cell division
  - Chromomere
  - Centrosome
  - Centromere
  - Chromonema
- The centromere is found at the centre of the \_\_\_\_\_ chromosome.
  - Telocentric
  - Metacentric
  - Sub-metacentric
  - Acrocentric
- The \_\_\_\_\_ units form the backbone of the DNA.
  - 5 carbon sugar
  - Phosphate
  - Nitrogenous bases
  - Sugar phosphate
- Okasaki fragments are joined together by \_\_\_\_\_.
  - Helicase
  - DNA polymerase
  - RNA primer
  - DNA ligase
- The number of chromosomes found in human beings are \_\_\_\_\_.
  - 22 pairs of autosomes and 1 pair of allosomes.
  - 22 autosomes and 1 allosome
  - 46 autosomes
  - 46 pairs autosomes and 1 pair of allosomes.

- The loss of one or more chromosome in a ploidy is called \_\_\_\_\_.
  - Tetraploidy
  - Aneuploidy
  - Euploidy
  - polyploidy

### II. Fill in the blanks

- The pairs of contrasting character (traits) of Mendel are called \_\_\_\_\_.
- Physical expression of a gene is called \_\_\_\_\_.
- The thin thread like structures found in the nucleus of each cell are called \_\_\_\_\_.
- DNA consists of two \_\_\_\_\_ chains
- An inheritable change in the amount or the structure of a gene or a chromosome is called \_\_\_\_\_.

### III. Identify whether the statement are True or False. Correct the false statement

- A typical Mendelian dihybrid ratio of  $F_2$  generation is 3:1.
- A recessive factor is altered by the presence of a dominant factor.
- Each gamete has only one allele of a gene.
- Hybrid is an offspring from a cross between genetically different parent.
- Some of the chromosomes have an elongated knob-like appendages known as telomere.
- New nucleotides are added and new complementary strand of DNA is formed with the help of enzyme DNA polymerase.
- Down's syndrome is the genetic condition with 45 chromosomes.

**IV. Match the following**

1. Autosomes - Trisomy 21
2. Diploid condition - 9:3:3:1
3. Allosome - 22 pair of chromosome
4. Down's syndrome - 2n
5. Dihybrid ratio - 23<sup>rd</sup> pair of chromosome

**V. Answer in a sentence**

1. What is a cross in which inheritance of two pairs of contrasting characters are studied?
2. Name the conditions when both the alleles are identical?
3. A garden pea plant produces axial white flowers. Another of the same species produced terminal violet flowers. Identify the dominant trait?
4. What is the name given to the segments of DNA, which are responsible for the inheritance of a particular character?
5. Name the bond which binds the nucleotides in a DNA.

**VI. Short answers questions**

1. Why did Mendel select pea plant for his experiments?
2. What do you understand by the term phenotype and genotype?
3. What are allosomes?
4. What are Okazaki fragments?
5. Why is euploidy considered to be advantageous to both plants and animals?
6. A pure tall plant (TT) is crossed with pure dwarf plant (tt), what would be the F<sub>1</sub> and F<sub>2</sub> generations? Explain.
7. Explain the structure of a chromosome.
8. Label the parts of the DNA in the diagram given below. Explain the structure briefly.

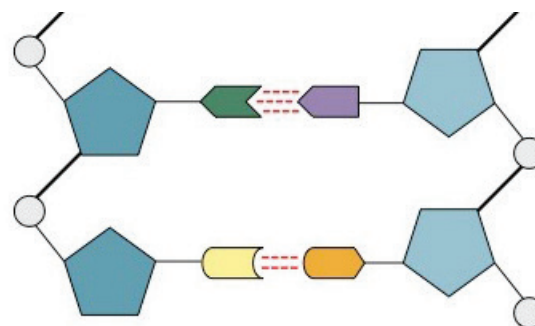

**VII. Long answer questions**

1. Explain with an example the inheritance of dihybrid cross. How is it different from monohybrid cross?
2. How is the structure of DNA organised? What is the biological significance of DNA?
3. The sex of the new born child is a matter of chance and neither of the parents may be considered responsible for it. What would be the possible fusion of gametes to determine the sex of the child?

**VIII. Higher Order Thinking Skills (HOTS)**

1. Flowers of the garden pea are bisexual and self-pollinated. Therefore, it is difficult to perform hybridization experiment by crossing a particular pistil with the specific pollen grains. How Mendel made it possible in his monohybrid and dihybrid crosses?
2. Pure-bred tall pea plants are first crossed with pure-bred dwarf pea plants. The pea plants obtained in F<sub>1</sub> generation are then selfed to produce F<sub>2</sub> generation of pea plants.
  - a. What do the plants of F<sub>1</sub> generation look like?
  - b. What is the ratio of tall plants to dwarf plants in F<sub>2</sub> generation?
  - c. Which type of plants were missing in F<sub>1</sub> generation but reappeared in F<sub>2</sub> generation?



3. Kavitha gave birth to a female baby. Her family members say that she can give birth to only female babies because of her family history. Is the statement given by her family members true. Justify your answer.

**IX. Value based question**

1. Under which conditions does the law of independent assortment hold good and why?

**REFERENCE BOOKS**

1. Veer Bala Rastogi, Introductory Cytology, Rastogi Publications, Meerut
2. P.S. Verma and V.K. Agarwal, Genetics, S. Chand and Company, New Delhi
3. Gerald Karp, Janet Iwasa and Wallace Marshall, Cell and Molecular Biology - Concepts and Experiment, 8<sup>th</sup> Edition, Wiley and Sons Publishers

**INTERNET RESOURCES**

- <https://www.genome.gov>
- <https://www.genetics.edu.au>
- <https://www.bioexplorer.net/chromosomal-mutation.html/>
- <https://www.ndss.org/about-down-syndrome/down-syndrome/>

**Concept Map**

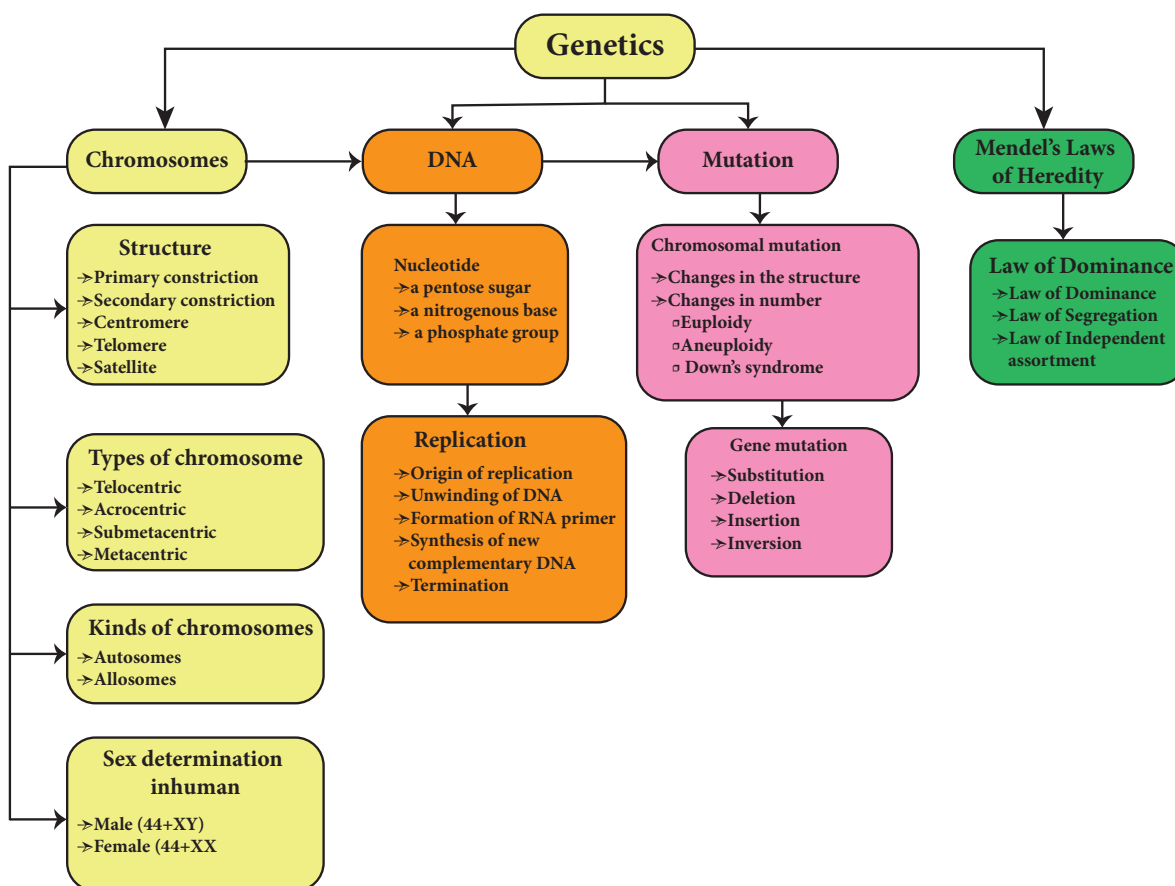

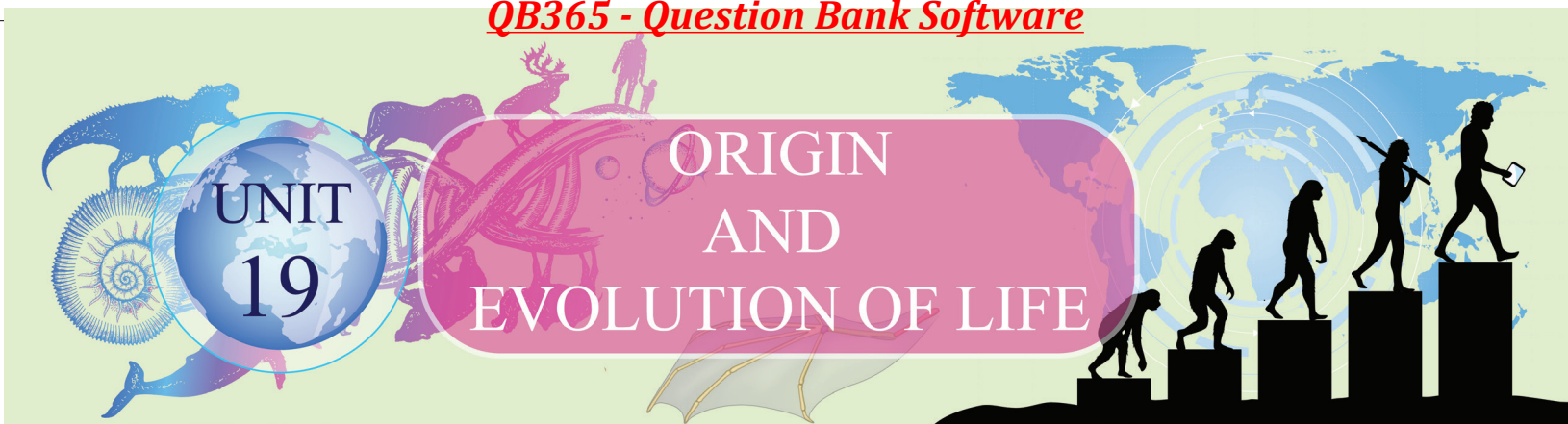

## Learning Objectives



At the end of this lesson the students will be able to:

- ◆ Know about Big Bang theory on the origin of universe.
- ◆ Understand theories of origin of life.
- ◆ Discuss the process of evolution on the basis of the available evidences.
- ◆ Relate the principles of Lamarck and Darwin with evolution.
- ◆ Know how variation occurs and its significance.
- ◆ List the importance of fossils and describe the process of fossilization.
- ◆ Identify the plants of ethnobotanical importance.
- ◆ Realize about extraterrestrial life.

## Introduction

Living organisms possess distinct characteristics, display organisational and functional unity, entail a mechanism of origin and evolution of diversities and maintain a balanced relationship with nature. Most aspects of evolution indicate that the knowledge of the past has become essential for fully understanding the present. Life since its beginning on earth had changed through time. The history of life comprises of two aspects, one is the origin of life on earth and the other is mechanism involved in the gradual changes and adaptations of living organisms through time which is known as the evolution of life.

**Origin of Earth:** Origin of life is linked with the origin of earth. The **Big Bang theory** explains the **Origin of Universe**. It proposes that the universe had an explosive beginning

(Big Bang) and originated 15 billion years ago. The universe comprised of stars, clouds of gas and dust which form the galaxies. The solar system was probably created when the gaseous clouds started to collapse due to the force of its own gravity forming atoms and particles. Atoms, dust grains and gaseous disc aggregated to form clumps and gave rise to planets. This forms the solar system of the milky way galaxy. Earth was supposed to have been formed about 4.5 billion years back. Life appeared 500 million years after the formation of earth.

### 19.1 Theories on Origin of Life

Many theories have been postulated to explain the origin of life. The views on the origin of life has been putforth as

**Special creation:** This idea embodies that life on Earth is a divine creation and also

attributes to **supernatural event** at a particular time in the past. It also emphasizes that life has not changed ever since its origin.

**Spontaneous generation (Abiogenesis):** According to this theory **life originated** spontaneously from **lifeless matter**. It was believed that fishes originated from mud, frogs from moist soil and insects from decaying matter.

**Biogenesis:** It was speculated by **Louis Pasteur** (1862) that **life originates from pre-existing life**. He showed that pre-sterilised flasks kept closed airtight, with killed yeast, did not give rise to any life form, while in another flask kept open to air living organisms arose from killed yeast.

**Extraterrestrial or Cosmic origin:** Some scientists still believe that life came from outer space. This states that units of life called **spores (Panspermia)** were transferred to different planets including earth. This is still an idea of some astronomers.

**Chemical Evolution of Life:** This idea was developed by **Oparin (1922)** and **Haldane (1929)**. They proposed that with the conditions prevailing on earth, life arose by a series of sequential **chemical reactions**. The first form of life could have come from pre-existing **non-living inorganic molecules** which gave rise to formation of **diverse organic molecules** which are transformed into **colloid system** to produce life. The modern concept on chemical evolution regarding origin of life was accepted.

## 19.2 Evidences of Evolution

Evolution can be better understood only by observing the interrelationship between the existing organisms and also relating the similarities with the extinct organisms. The interrelationship of the organisms is also supported by evidences from different branches of biology. These evidences support the concept that all organisms have evolved from common ancestors.

### 19.2.1 Evidences from Morphology and Anatomy

The comparative study of morphology and anatomy of animals, reveal that they possess common set of characteristics.

- i. **Homologous organs:** The homologous organs are those which have inherited from common ancestors with similar developmental pattern in embryos. The fore limbs of mammals are homologous structures. A human hand, a front leg of a cat, flipper of a whale and a bat's wing **look dissimilar and adapted for different functions**. Their mode of development and basic structure of bone are similar.

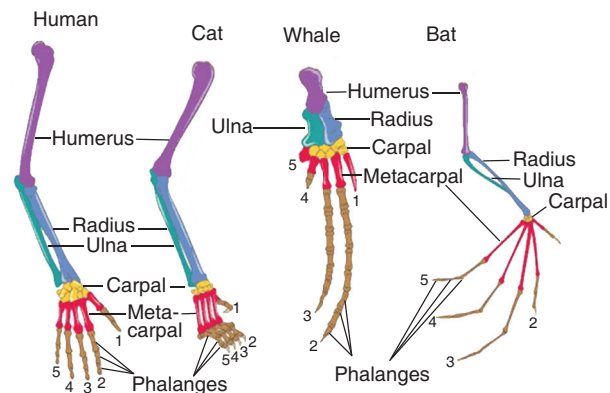

**Figure 19.1** Forelimbs of vertebrates showing homologous structure

- ii. **Analogous organs:** The analogous organs **look similar** and **perform similar functions** but they have different origin

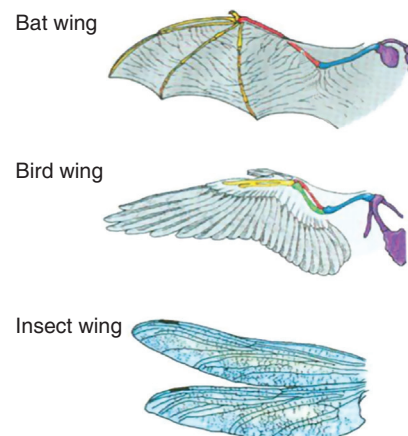

**Figure 19.2** Analogous structure showing a bat wing, a bird wing and an insect wing

and developmental pattern. The function of the wings of a bat, the wings of a bird and wings of an insect are similar, but their basic structures are different.

- iii. **Vestigial organs:** The **degenerated** and **non-functional organs** of animals are called vestigial organs. The same organs are found to be well-developed and functional, in some of the related forms. Some of the vestigial organs in man are vermiform appendix, nictitating membrane, caudal vertebra, coccyx etc.
- iv. **Atavism:** The **reappearance of ancestral characters** in some individuals is called atavism. e.g. Presence of rudimentary tail in new born babies, presence of thick hair on the human body.

### 19.2.2 Evidences from Embryology

The study of comparative embryology of different animals, supports the concept of evolution. The embryos from fish to mammals are similar in their early stages of development. The differentiation of their special characters appear in the later stages of development.

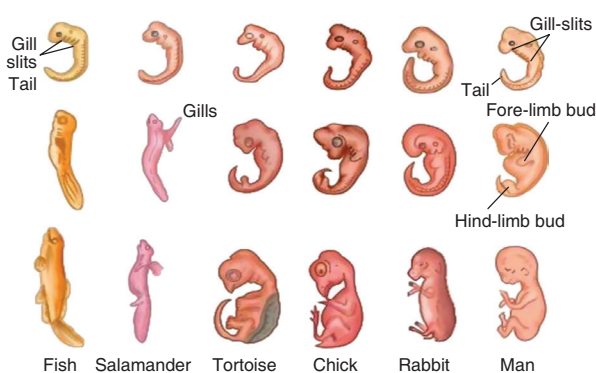

Figure 19.3 Embryonic development of vertebrates

**Biogenetic law** or **Recapitulation theory** was given by **Ernst Haeckel**. According to this theory, **Ontogeny recapitulates Phylogeny**. The stages of development of the individual

animal repeats the evolutionary history of the entire race of the animal.

### 19.2.2 Evidences from Palaeontology

Palaeontology deals with the study of fossils. **Leonardo da Vinci** is called the **Father of Palaeontology**. The study of fossils helps us to understand the line of evolution of many invertebrates and vertebrates. Fossil records show that the evolution has taken a gradual process from simple to complex organisms. The origin of modern birds is supported by the evidences from palaeontology.



**Archaeopteryx:** Archaeopteryx is the oldest known **fossil bird**. It was an early bird-like form found in the Jurassic period. It is considered to be a **connecting link** between reptiles and birds. It had wings with feathers, like a bird. It had long tail, clawed digits and conical teeth, like a reptile.



Figure 19.4 Archaeopteryx - Fossil bird

## 19.3 Theories of Evolution

Life had evolved along with evolution of earth towards the end of 18<sup>th</sup> century. **Evolution** is the **gradual change** occurring in living organisms over a period of time. Formation of new species due to changes in specific characters over several generations as response to natural selection, is called evolution. The natural changes occurring is explained through the theories of evolution as proposed by Lamarck and Darwin.

### 19.3.1 Lamarckism

Jean Baptiste Lamarck (1744-1829) was a French naturalist, well known for his theory of evolution. Lamarck's theory of evolution was published in 'Philosophic Zoologique' in the year 1809. It is popularly known as 'Theory of inheritance of Acquired Characters' or "Use and Disuse theory" or Lamarckism.

#### Principles of Lamarckism

##### i. Internal vital force

Living organisms or their component parts tend to increase in size continuously. This increase in size is due to the inherent ability of the organisms.

##### ii. Environment and new needs

A change in the environment brings about changes in the need of the organisms. In response to the changing environment, the organisms develop certain adaptive characters. The adaptations of the organisms may be in the form of development of new parts of the body.

##### iii. Use and disuse theory

Lamarck's **use and disuse theory** states that if an organ is used constantly, the organ develops well and gets strengthened. When an organ is not used for a long time, it gradually degenerates.

The ancestors of giraffe were provided with short neck and short forelimbs. Due to shortage of grass, they were forced to feed on

leaves from trees. The continuous stretching of their neck and forelimbs resulted in the development of long neck and long forelimbs which is an example for constant use of an organ. The degenerated wing of Kiwi is an example for organ of disuse.

##### iv. Theory of Inheritance of acquired characters

When there is a change in the environment, the animals respond to the change. They develop adaptive structures. The characters developed by the animals during their life time, in response to the environmental changes are called **acquired characters**. According to Lamarck, the acquired characters are transmitted to the offspring by the process of inheritance.

### 19.3.2 Darwinism or Theory of Natural Selection

**Charles Darwin** (1809-1882) was one of the great naturalist and philosopher of 18<sup>th</sup> century. He was born in England in 1809. While studying in college through his friendship with Professor J.S.Henslow he was fascinated towards nature. At that time the British Admiralty planned a **voyage of exploration** for 5 years on a ship named **H.M.S. Beagle** around **South America**. Dr Henslow was asked to nominate a young naturalist for the voyage. Darwin was given the opportunity. During his five years (1831-1835) voyage he visited many parts of

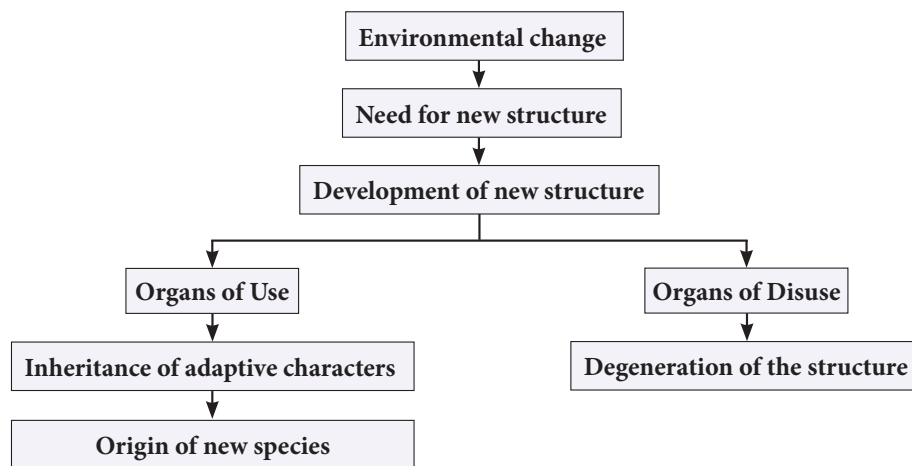

Flow chart showing the postulates of Lamarckism

the world, a number of islands including the **Galapagos island** and **Pacific island**. Darwin made elaborate observations on nature of the land, plants and animals of the regions he visited. He further worked for a period of 20 years to develop the theory of natural selection.

Darwin published his observations and conclusions under the name '**Origin of species**' in **1859**. The book of Darwin demonstrates the fact of evolution. It elaborates on the **theory of Natural selection** for evolutionary transformation,

**Principles of Darwinism**

**i. Overproduction**

Living beings have the ability to reproduce more individuals and form their own progeny. They have the capacity to multiply in a geometrical manner. This will increase reproductive potential leading to overproduction.

**ii. Struggle for existence**

Due to over production, a geometric ratio of increase in population occurs. The space to live and food available for the organisms

remain the same. This creates an intense competition among the organisms for food and space leading to struggle. The struggle for existence are of three types:

- a. **Intraspecific struggle:** Competition among the individuals of same species.
- b. **Interspecific struggle:** Competition between the organisms of different species living together.
- c. **Environmental struggle:** Natural conditions like extreme heat or cold, drought and floods can affect the existence of organisms

**iii. Variations**

The occurrence of variation is a characteristic feature of all plants and animals. **Small variations** are important for evolution. According to Darwin **favourable variations** are useful to the organism and **unfavourable variations** are harmful or useless to the organism.

**iv. Survival of the fittest or Natural selection**

During the struggle for existence, the organisms which can overcome the challenging situation, **survive** and **adapt** to

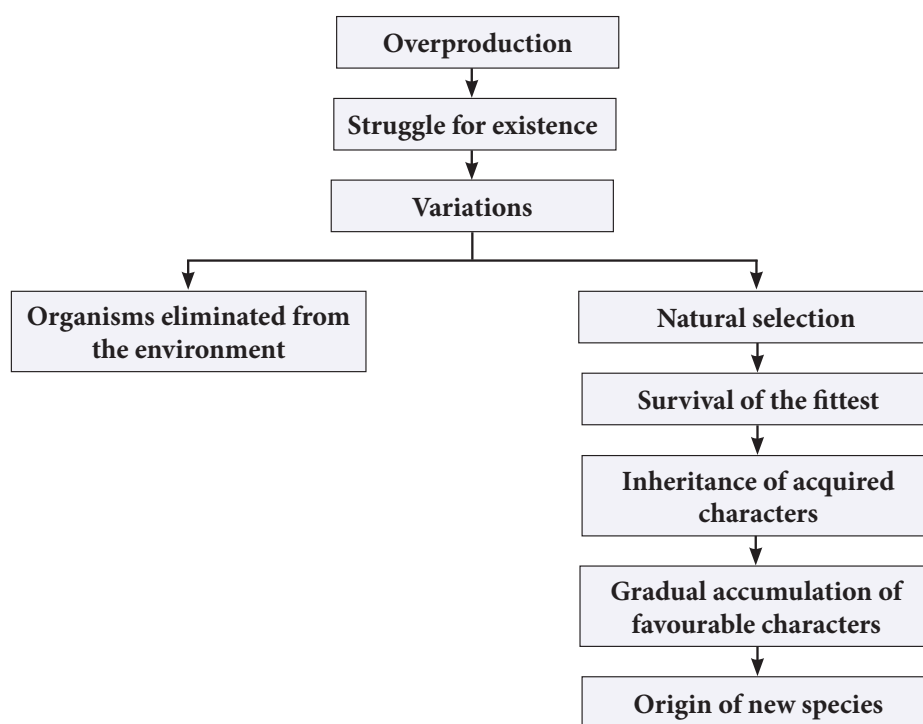

Flowchart showing the postulates of Darwinism

the surrounding environment. Organisms which are unable to face the challenges, are unfit to survive and disappear. The process of selection of organisms with favourable variation is called as natural selection.

#### v. Origin of species

According to Darwin, **new species originates by the gradual accumulation of favourable variations** for a number of generations.

### 19.4 Variation

Sexual reproduction, which involves meiosis helps in **recombination of genes** during gametic fusion. This leads to differences in the phenotype of the offspring from its parents. These differences are called variation.

Variation is the difference found among individuals of the same species and the offspring of the same parent. **Variation** is the **raw material** which plays an important **role in evolution**. Evolution would not be possible without variation.

#### Types of variations

**Somatic variation:** These are the variations which affect the body (somatic) cells of the organisms. They are **not heritable**. They occur due to environmental factors.

**Germinal variation:** These variations are produced in germ cells of an organism. They are **inherited**. They may be present in ancestors or may occur suddenly. They are classified into two types:

1. Continuous variation
2. Discontinuous variation

**Continuous variation:** These are small variations which occur among individuals of a population. They are also called as **fluctuating variations**. They occur by **gradual accumulation** in a population. e.g. skin colour, height and weight of an individual, colour of eye, etc.

**Discontinuous variation:** These are **sudden changes** which occur in an organism due to mutations. They do not have any intermediate forms. These large variations are not useful for evolution. e.g. short legged Ancon sheep, six or more digits (fingers) in human, etc.

Discontinuous variation form the basis for **Mutation theory** proposed by **De Vries**.

#### Relationship between Mutation and Variation

**Mutation and Variation** are two events involved in the process of evolution. Mutation arises due to errors occurring in DNA during replication or exposure to UV rays or chemicals. Mutation leads to variation. It brings about changes in a single individual.

### 19.5 Paleobotany

Paleobotany is derived from Greek words *paleon* that means “old” and *botany* the study of plants. It is the branch of paleontology that deals with **recovery and identification of plant remains of geological past**.

A plant fossil is any preserved part of a plant that has died long back. Fossils may be a prehistoric impression that may be hundred to millions of years old. Majority of the plant fossils are disarticulated parts of plants, it is rare to find plants to be preserved as whole.

#### Importance of fossils

- i They throw light on phylogeny and evolution of plants.
- ii Fossil plants give a historical approach to plant kingdom.
- iii Fossils are useful in classification of plants.
- iv. Fossil plants can be used in the field of descriptive and comparative anatomy.

**Kaspar Maria Von Sternberg**

He is the “**Father of Paleobotany**” (1761–1838) was born in Europe. He established the Bohemian National Museum in Prague and is deemed to be the founder of Modern Paleobotany.

**Birbal Sahani**

He is the “**Father of Indian Paleobotany**” (1891–1949). He presented his research on two different areas of Paleobotany (i) The anatomy and morphology of Paleozoic Ferns (ii) The fossil plants of the Indian Gondwana Formations.

**19.5.1 Fossilization**

The process of formation of fossil in the rocks is called fossilization.

Common methods of fossilization includes petrification, molds and cast, carbonization, preservation, compression and infiltration.

**Petrification**

Minerals like silica slowly penetrate in and replace the original organic tissue and forms a rock like fossil. This method of fossilization can **preserve hard and soft parts**. Most bones and wood fossils are petrified.

**Mold and Cast**

A replica of a plant or animal is **preserved in sedimentary rocks**. When the organism gets buried in sediment it is dissolved by underground water leaving a hollow depression called a mold. It shows the **original shape but does not reveal the internal structure**. Minerals or sediment fill the hollow depression and forms a cast.

**Preservation**

Original remains can be preserved in **ice** or **amber** (tree sap). They protect the organisms from decay. The entire plant or animal is preserved.

**Compression**

When an organism dies, the hard parts of their bodies settle at the **bottom of the sea**

and are **covered by sediment**. The process of sedimentation goes on continuously and fossils are formed.

**Infiltration or Replacement**

The **precipitation of minerals** takes place which later on infiltrate the cell wall. The process is brought about by several mineral elements such as silica, calcium carbonate and magnesium carbonate. Hard parts are dissolved and replaced by these minerals.



**Living Fossils:** These are living organisms that are similar in appearance to their fossilized distant ancestors and usually have no extinct close features. e.g. *Ginkgo biloba*.

**19.5.2 Determination of age of Fossils**

The age of fossils is determined by radioactive elements present in it. They may be carbon, uranium, lead or potassium. It is used in paleobotany and anthropology for determining the age of human fossils and manuscripts.

**Radioactive carbon ( $C^{14}$ ) dating method**

This method was discovered by **W.F. Libby** (1956). Carbon consumption of animals and plants stops after death and since then, only the decaying process of  $C^{14}$  occurs continuously. The time passed since death of a plant or animal can be calculated by measuring the amount of  $C^{14}$  present in their body.

**More to Know****What is the Geologic Time Scale?**

The geological time scale is a system of chronological dating that relates geological rock strata to time, and is used by geologists, paleontologists, and other Earth scientists to describe the timing and relationships of events that have occurred during Earth's history.





**Thiruvakkarai fossil wood park (Villupuram district, Tamil Nadu):** 2 million years ago tree trunks that got buried

along the river, in course of time the organic matter was replaced by silica and was fossilized. They retained their color, shape and texture and was converted into solid rocks. The annular rings, the texture, colors of the layers, nodes and every properties of plants are still visible.



## 19.6 Ethnobotany

Ethnobotany is the **study of a region's plants** and their **practical uses** through the **traditional knowledge** of the local culture of people. The term Ethnobotany was coined by **J.W. Harshberger** in 1895 to include the study of plants used by the primitive and aboriginal people. Though this discipline has existed for ages, ethnobotany emerged as a distinct academic branch of natural science in 20<sup>th</sup> century.

### Aspects of ethnobotany

Ethnobotany has relevance with problems of nutrition, health care and life support system, faith in plants, cottage industries, economic upliftment, conservation of biodiversity and sustainable use of plant resources.

### Importance of Ethnobotany

- ◆ It provides traditional uses of plant.
- ◆ It gives information about certain unknown and known useful plants.
- ◆ The ethnomedicinal data will serve as a useful source of information for the chemists, pharmacologists and practitioners of herbal medicine.

- ◆ Tribal communities utilize ethnomedicinal plant parts like bark, stem, roots, leaves, flower bud, flowers, fruits, seeds, oils, resins, dyes, gum for the treatment of diseases like diarrhoea, fever, headache, diabetes, jaundice, snakebites, leprosy, etc.

## 19.7 Astrobiology/Exobiology

Are we alone in the universe? If your answer is no, then how do you detect the existence of life in space? Astrobiology/exobiology is the science which looks for the presence of **extra terrestrial life in the universe**.

Astrobiology deals with the **origin, evolution and distribution of life in the universe** and to investigate the possibility of life in other world.

The major concept in astrobiology is the **habitable zone**. The theory explains that any **planets can support the existence of life**, if it fulfills two important criteria.

- i It must have a right mass to retain an atmosphere.
- ii It must have an orbit at just the right distance from its star (Sun) that it allows liquid water to exist. Thus, the distance need to be neither too hot or not too cold and is often referred as **Goldilock Zone for life**.

In our solar system 'Earth' is the only planet in the goldilock zone. Since, this zone varies at times as the star evolves, we know that Mars have also been habitable. The life on Mars are likely to be the creatures, we find in extreme environments on earth.

The organisms which live in extreme environmental conditions on earth are called **extremophiles**. Thus, within our own Solar System, there are many areas that are different from the Earth where it is probable to find the presence of life similar to extremophile bacteria.

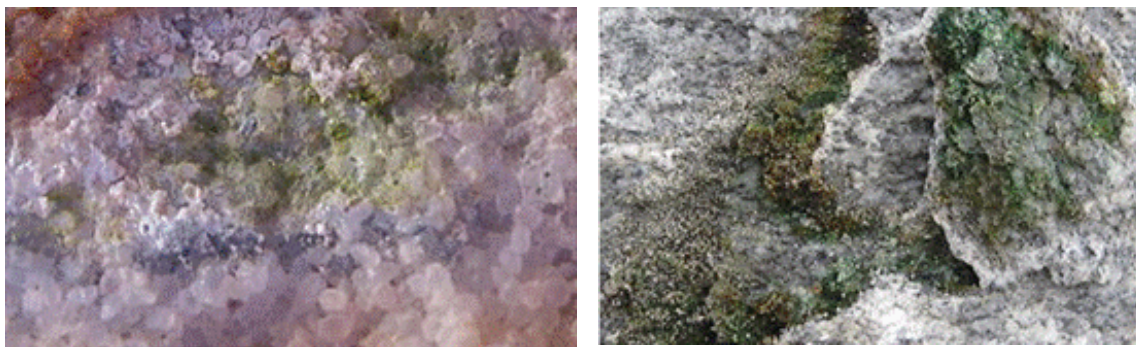

Figure 19.5 Microbial diversity from sandstone and granite from the McMurdo Dry Valleys, Antarctica



NASA is developing the Mars 2020 astrobiology to investigate an astrobiologically relevant ancient environment on Mars, its surface geological processes and the possibility of past life on Mars and preservation of biosignatures within accessible geological materials.

**Points to Remember**

- ❖ Lamarck proposed that the acquired characters are passed on to the offsprings in the next generation
- ❖ Internal vital force, environment and new needs, use and disuse theory and inheritance of acquired characters are the main principles of Lamarckism.
- ❖ Overproduction, struggle for existence, variations, survival of the fittest or Natural selection and origin of species are the main postulates of Darwinism.
- ❖ Each species tends to produce large number of offsprings, but only the fittest can survive.
- ❖ Homologous, analogous organs and embryological evidences explain evolutionary relationships.
- ❖ Some traits in organisms would be similar because they are inherited from a common ancestor.
- ❖ Fossils are evidences of ancient life forms or ancient habitats which have been preserved by natural processes.
- ❖ Ethnobotanical importance of various types of plants are know through traditional knowledge.
- ❖ Astrobiology/exobiology is the science which looks for the presence of extra terrestrial life in the universe



**TEXTBOOK EVALUATION**



**I Choose the correct answer**

1. Biogenetic law states that \_\_\_\_\_
  - a. Ontogeny and phylogeny go together
  - b. Ontogeny recapitulates phylogeny
  - c. Phylogeny recapitulates ontogeny
  - d. There is no relationship between phylogeny and ontogeny
2. The 'use and disuse theory' was proposed by \_\_\_\_\_
  - a. Charles Darwin
  - b. Ernst Haeckel
  - c. Jean Baptiste Lamarck
  - d. Gregor Mendel

3. Paleontologists deal with
  - a. Embryological evidences
  - b. Fossil evidences
  - c. Vestigial organ evidences
  - d. All the above
4. The best way of direct dating fossils of recent origin is by
  - a. Radio-carbon method
  - b. Uranium lead method
  - c. Potassium-argon method
  - d. Both (a) and (c)
5. The term Ethnobotany was coined by
 

a. Khorana	b. J.W. Harsbberger
c. Ronald Ross	d. Hugo de Vries

**II Fill in the blanks**

1. The characters developed by the animals during their life time, in response to the environmental changes are called \_\_\_\_\_.
2. The degenerated and non-functional organs found in an organism are called \_\_\_\_\_.
3. The forelimbs of bat and human are examples of \_\_\_\_\_ organs.
4. The theory of natural selection for evolution was proposed by \_\_\_\_\_.

**III State true or false. Correct the false statements**

1. The use and disuse theory of organs' was postulated by Charles Darwin.
2. The homologous organs look similar and perform similar functions but they have different origin and developmental pattern.
3. Birds have evolved from reptiles.

**IV Match the following**

<b>Column A</b>	<b>Column B</b>
a) Atavism	caudal vertebrae and vermiform appendix
b) Vestigial organs	a forelimb of a cat and a bat's wing
c) Analogous organs	rudimentary tail and thick hair on the body
d) Homologous organs	a wing of a bat and a wing of an insect
e) Wood park	radiocarbon dating
f) W.F. Libby	Thiruvakkarai

**V Answer in a word or sentence**

1. A human hand, a front leg of a cat, a front flipper of a whale and a bat's wing look dissimilar and adapted for different functions. What is the name given to these organs?
2. Which organism is considered to be the fossil bird?
3. What is the study of fossils called?

**VI Short answers questions**

1. The degenerated wing of a kiwi is an acquired character. Why is it an acquired character?
2. Why is Archaeopteryx considered to be a connecting link?
3. Define Ethnobotany and write its importance.
4. How can you determine the age of the fossils?

**VII Long answer questions**

1. Natural selection is a driving force for evolution-How?
2. How do you differentiate homologous organs from analogous organs?
3. How does fossilization occur in plants?

**IX Higher Order Thinking Skills (HOTS)**

1. Arun was playing in the garden. Suddenly he saw a dragon fly sitting on a plant. He observed the wings of it. He thought it looked similar to a wing of a crow. Is he correct? Give reason for your answer.
2. Imprints of fossils tell us about evolution-How?
3. Octopus, cockroach and frog all have eyes. Can we group these animals together to establish a common evolutionary origin. Justify your answer.

2. Stephen. C. Stearns and Rolf. F. Hoekstra Evolution - An introduction
3. Archer, S.D.J., Asuncion de los, R., Lee, K.C., Niederberger, T.S., Cary, S.C., Coyne, K.J., Douglas, S., Lacap-Bugler, D.C. and Pointing, S.B., 2017. A Endolithic microbial diversity in sandstone and granite from the McMurdo Dry Valleys, Antarctica. *Polar biology*, 40 (5): 997-1006.

**REFERENCE BOOKS**

1. B. S. Tomar and S. P. Singh, An Introduction to General Biology, 9<sup>th</sup> Edition, Rastogi Publications, Meerut.

**INTERNET RESOURCES**

- <http://www.nhs.uk>
- <http://www.eniscuola.net/en/2012/11/29/exobiology/>
- <https://en.wikipedia.org/wiki/Astrobiology>

**Concept Map**

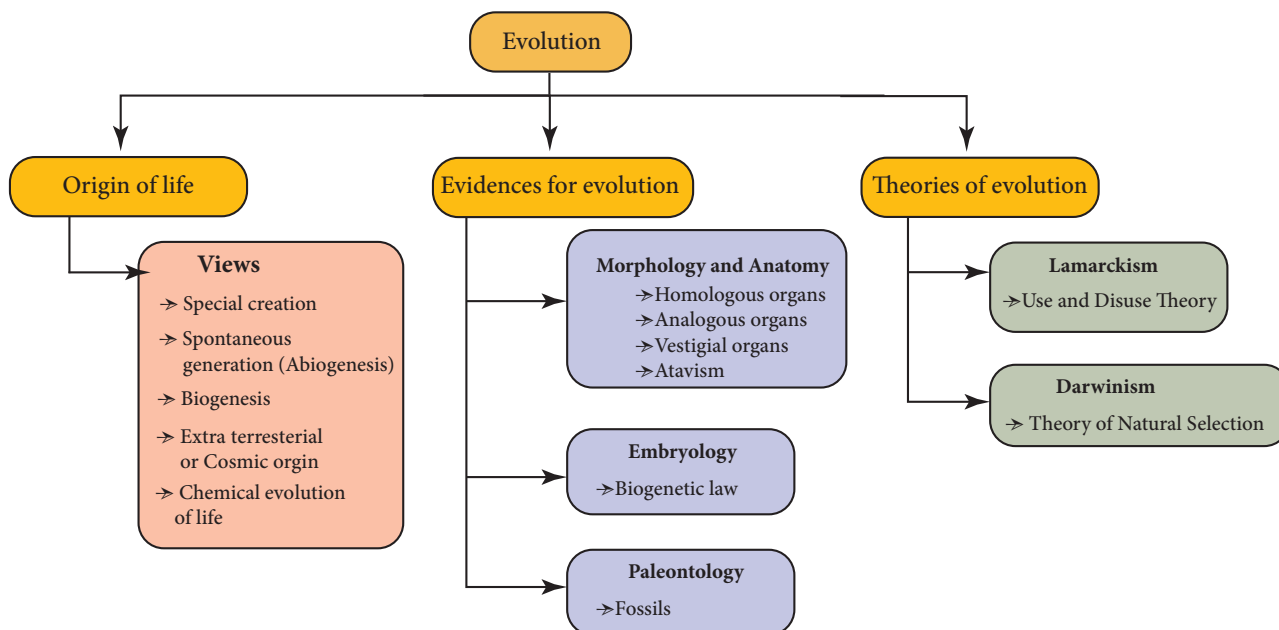

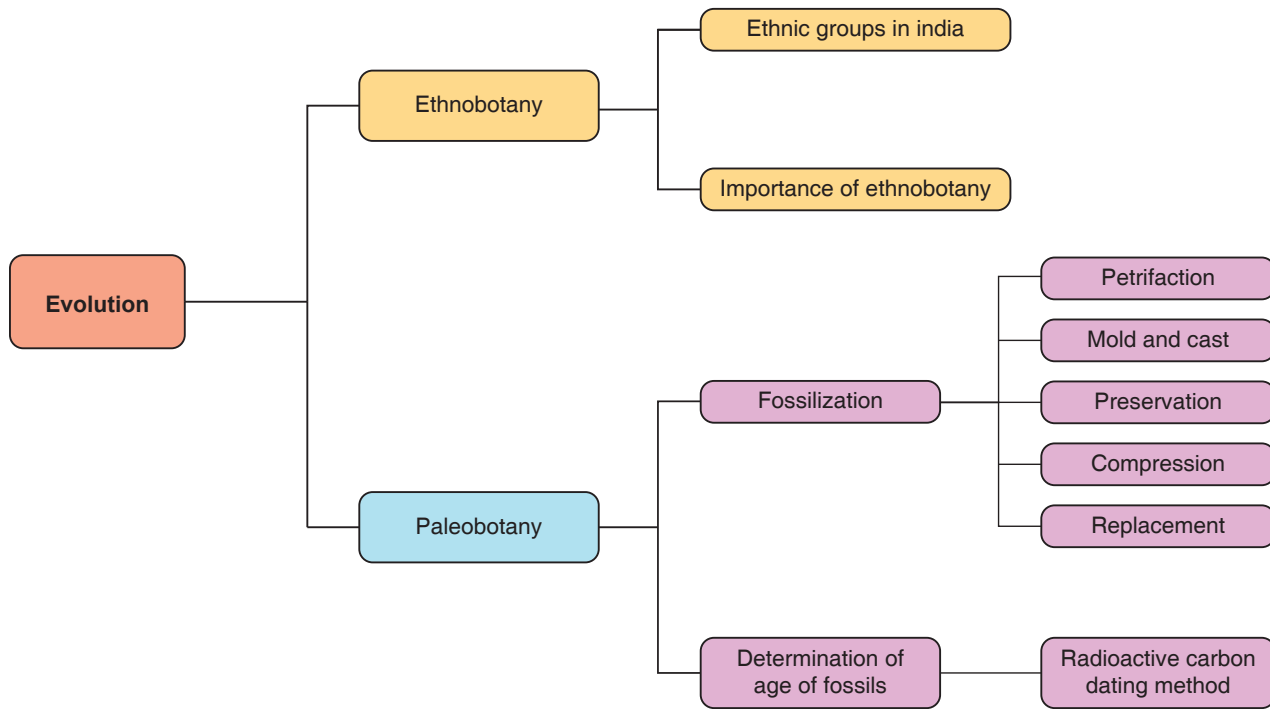

## ICT CORNER ORIGIN AND EVOLUTION OF LIFE

This game will enable the students to understand the evolution of living organisms. But it was created on the basis of general truths and not specific scientific related.

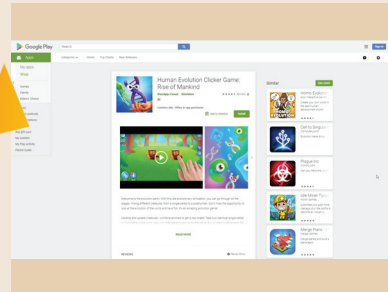

### Steps

- Access the application “HUMAN EVOLUTION CLICKER GAME:RISE OF MANKIND” with the help of provided URL or QR code. Download and Install it in the mobile.
- You can view a bubble for ten seconds, touch it to reveal the hidden DNA.
- By joining two DNAs, a bacteria will be formed. By joining two bacteria, amoeba will be appeared.
- Continue the same to form many other species by combining different species. There are 52 living organism exist now in the application. Explore everything.

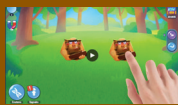

Step1



Step2

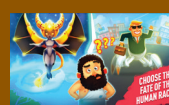

Step3



Step4

### Cells alive

<https://play.google.com/store/apps/details?id=com.banana4apps.evolution&hl=en>

\*Pictures are indicative only



B375\_10\_SCIENCE\_EM



# BREEDING AND BIOTECHNOLOGY



## Learning Objectives



At the end of this lesson the students will be able to :

- ◆ Define and discuss the steps and methods involved in plant breeding.
- ◆ Know the crop varieties produced by crop improvement.
- ◆ Understand animal breeding and its implications.
- ◆ Point out the differences between inbreeding and outbreeding.
- ◆ Know what is hybrid vigour and its importance.
- ◆ Identify the steps involved in genetic engineering.
- ◆ Understand the practical applications of DNA fingerprinting.
- ◆ Gain knowledge on gene therapy.
- ◆ Know the importance of stem cell technology.

## Introduction

India's population is likely to reach 1.7 billion by 2050. Current rate of India's food production will be able to meet only 59% of the country's food demand at that time. How can India feed 1.7 billion people by 2050? This can be made possible by 'Plant breeding' and 'Animal husbandry'.

Plant breeding is the art of developing economically important plants with superior quality.

Animal husbandry involves the breeding of animals. It aims at improving the genotypes of animals to make them more useful to the welfare of mankind. This emphasizes domestication and propagation of animals, under controlled conditions to enhance food production and food quality.

Another breakthrough was the emergence of biotechnology as an entity of modern biology,

which paved way to develop advanced healthcare products, diagnostic kits and food production to improve the quality of human life.

### 20.1 Modern Agricultural Practices and Crop Improvement

Modern agricultural practices are activities carried out to improve cultivation of plants. It includes preparation of soil, sowing, application of manures and fertilizers, proper irrigation, protection from weeds and pests harvesting, threshing and storage.

The aim of crop improvement is to develop improved crop varieties possessing higher yield, better quality, resistance to diseases and shorter duration.

### 20.2 Green Revolution

Green Revolution is the process of increasing food production through high

yielding crop varieties and modern agricultural techniques in underdeveloped and developing nations. **Dr. Norman E. Borlaug**, an American agronomist the “**Father of the Green Revolution**”, received the Nobel Peace Prize in 1970. In India **Dr. M. S. Swaminathan** joined with Dr. Borlaug in bringing Green Revolution by introducing Mexican wheat varieties. This eventually increased wheat and rice production between 1960 and 2000.

### 20.2.1 Breeding for high yield and better quality

Major challenge that India faced during post-independence period was having enough food production for the growing population. Efforts were taken to develop high yielding varieties of crops, leading to Green Revolution.

#### Semi-Dwarf varieties in Wheat and Rice

**Sonalika, Kalyan Sona** are semi-dwarf varieties of wheat developed from high-yielding, semi-dwarf, fertilizer responsive wheat varieties from **Mexico**. **IR-8** (Miracle rice) is a high-yielding semi-dwarf rice variety developed by International Rice Research Institute (IRRI), Philippines. In 1966, this was first introduced in Philippines and India. It was a hybrid of a high yielding rice variety

**Peta** from Indonesia, and **Dee-geo-woo-gen** (DGWG) a dwarf variety from China.



Figure 20.1 IR-8

#### More to Know

##### Dr. G. Nammalvar

Dr. G. Nammalvar (1938-2013) was a Tamil agricultural scientist, environmental activist and organic farming expert. He founded Nammalvar Ecological Foundation for Farm Research and Global Food Security Trust (NEFFFRGFST-Vanagam) to create public awareness about the benefits of organic farming.



#### More to Know

##### Dr. M. S. Swaminathan

Dr. Mankombu Sambasivan Swaminathan is an Indian scientist known for his leading role in India's Green Revolution. His research on potato, wheat, rice and jute are well known plant breeding experiments. Due to his efforts the wheat production increased from twelve million tonnes in 1960's to seventy million tonnes now. He is aptly called as the “Father of Indian Green Revolution”.



### 20.2.2 Plant Breeding for Disease Resistance

Plant diseases are caused by pathogens like viruses, bacteria and fungi. This affects crop yield. Hence, it is important to develop disease resistant varieties of crops, that would increase the yield and reduce the use of fungicides and bactericides. Some disease resistant varieties developed by plant breeding are given below:

Table 20.1 Disease resistant crop varieties

Crop	Variety	Resistance to diseases
Wheat	Himgiri	Leaf and stipe rust, hill bunt
Cauliflower	Pusa Shubhra, Pusa Snowball K-1	Black rot
Cowpea	Pusa Komal	Bacterial blight

### 20.2.3 Plant Breeding for Insects/Pests Resistance

In addition to microorganisms, a large number of insects and pests also cause damage to the crops. Hence, insect and pest resistant crop varieties were developed. Some of them are given below:

**Table 20.2** Insects /pests resistant varieties

Crop	Variety	Resistant to Insects/Pests
Brassica	Pusa Gaurav	Aphids
Flat Bean	Pusa Sem 2, Pusa Sem 3	Leaf hopper, aphids and fruit borer
Lady's finger	Pusa Sawani, Pusa A4	Shoot and fruit borer

### 20.2.4 Plant Breeding for Improved Nutritional Quality

Undernutrition and protein malnutrition among human population is a major health problem which has been receiving much focus throughout the world. Apart, from humans it also affects the health of farm animals. To combat these conditions, human and animal health are to be determined by the nutritional quality of the feed crops. The nutritional quality of crops depends on quality and quantity of nutrients. The nutritional quality may be improved with respect to its

1. Protein content and quality of protein
2. Oil content
3. Mineral content

#### Biofortification

Biofortification is the scientific process of developing crop plants enriched with high levels of desirable nutrients like vitamins, proteins and minerals. Some examples of crop varieties developed as a result of biofortification are given below:

1. Protina, Shakti and Rathna are lysine rich maize hybrids (developed in India).



**Figure 20.2** Protina-lysine rich Maize

2. Atlas 66, a protein rich wheat variety.



**Figure 20.3** Atlas 66-protein rich Wheat

3. Iron rich fortified rice variety.
4. Vitamin A enriched carrots, pumpkin and spinach.

## 20.3 Methods of Plant Breeding for Crop Improvement

Methods of plant breeding to develop high yielding varieties are given below:

1. Introduction of new varieties of plants
2. Selection
3. Polyploidy breeding
4. Mutation breeding
5. Hybridization

### 20.3.1 Introduction of New Varieties of Plants

It is a process of introducing high yielding varieties of plants from one place to another. Such plants are called as **exotic species**. These imported plant materials may carry pathogens and pests, hence they are thoroughly tested in a plant quarantine before being introduced to the fields. e.g *Phaseolus mungo* was introduced from China.



### 20.3.2 Selection

Selection is one of the oldest methods of plant breeding in which individual plants or groups of plants are sorted out from a mixed population based on the morphological characters.

#### Methods of selection

There are three methods of selection. They are

1. Mass selection
2. Pureline selection
3. Clonal selection

#### 1. Mass selection

Seeds of best plants showing desired characters are collected from a mixed population. The collected seeds are allowed to raise the second generation. This process is carried out for seven or eight generations. At the end, they will be multiplied and distributed to the farmers for cultivation.

Some common examples for mass selection are groundnut varieties like TMV-2 and AK-10. Its schematic representation is given below.

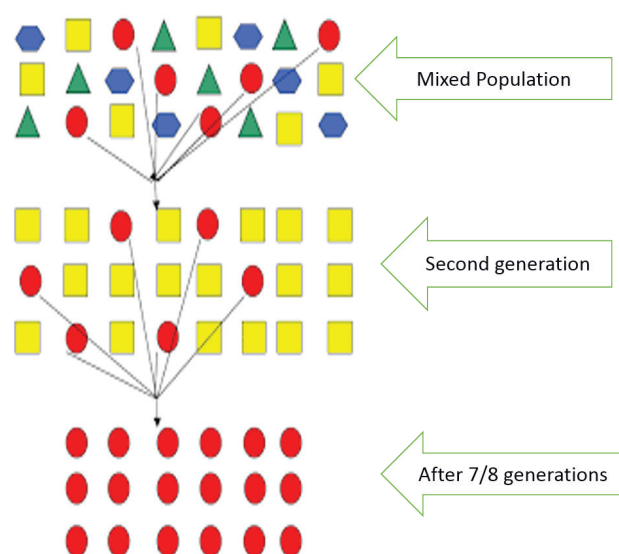

Figure 20.5 Mass Selection

#### 2. Pureline selection

Pureline is “the progeny of a single individual obtained by self breeding”. This

is also called as individual plant selection. In pureline selection large numbers of plants are selected from a self-pollinated crop and harvested individually.

Individual plant progenies from them are evaluated separately. The best one is released as a pureline variety. Progeny is similar both genotypically and phenotypically.

#### 3. Clonal selection

A group of plants produced from a single plant through vegetative or asexual reproduction are called **clones**.

All the plants of a clone are similar both in genotype and phenotype. Selection of desirable clones from the mixed population of vegetatively propagated crop is called **clonal selection**.

### 20.3.3 Polyploidy Breeding

Sexually reproducing organisms have two complete set of chromosomes in their somatic cells. This is called **diploid** ( $2n$ ). The gametic cells have only one set of chromosome. This is called **haploid** ( $n$ ). An organism having more than two sets of chromosomes is called **polyploid** (Greek : Polys = many + aploos = one fold + eidos = form). Such condition is called Polyploidy. It can be induced by **physical agents** such as heat or cold treatment, X-rays and **chemical agents** like colchicine.

#### Achievements of polyploidy breeding

Some achievements of polyploidy breeding are

- a. Seedless watermelons ( $3n$ ) and bananas ( $3n$ ).
- b. TV-29 (triploid variety of tea) with larger shoots and drought tolerance.
- c. *Triticale* ( $6n$ ) is a hybrid of wheat and rye. To make this plant fertile polyploidy is induced. It has higher dietary fibre and protein.
- d. *Raphano brassica* is an allotetraploid by colchicine treatment.

### 20.3.4 Mutation Breeding

Mutation is defined as the sudden **heritable change** in the nucleotide sequence of DNA in an organism. It is a process by which **genetic variations** are created which in turn brings about changes in the organism. The organism which undergoes mutation is called a mutant.

The factors which induce mutations are known as mutagens or **mutagenic agents**. Mutagens are of two types namely physical mutagens and chemical mutagens.

#### More to Know

##### Gamma Garden

Gamma garden or Atomic garden is a concept popularised after World War II for the peaceful use of atomic energy for crop improvement. This is a type of induced mutation breeding where radioactive sources particularly gamma rays from Cobalt-60 or Caesium-137 are used to induce desirable mutations in crop plants.



#### i Physical mutagens

Radiations like X-rays,  $\alpha$ ,  $\beta$  and  $\gamma$ -rays, UV rays, temperature etc. which induce mutations are called physical mutagens

#### ii Chemical mutagens

Chemical substances that induce mutations are called chemical mutagens. e.g. Mustard gas and nitrous acid. The utilisation of induced mutation in crop improvement is called **mutation breeding**.

#### Achievements of mutation breeding

Some achievements of mutation breeding are

- Sharbati Sonora** wheat produced from Sonora-64 by using gamma rays.
- Atomita 2 rice** with saline tolerance and pest resistance
- Groundnuts** with thick shells

### 20.3.5 Hybridization

Hybridization may be defined as the process of crossing two or more types of plants for bringing their desired characters together into one progeny called **hybrid**. Hybrid is superior in one or more characters to both parents. Hybridization is the common method of creating genetic variation to get improved varieties.

#### Hybridization Experiment: *Triticale* (The first man – made cereal)

*Triticale* is the first man- made cereal hybrid. It is obtained by crossing wheat (*Triticum durum*,  $2n = 28$ ) and rye (*Secale cereal*,  $2n = 14$ ). The  $F_1$  hybrid is sterile ( $2n = 21$ ). Then the chromosome number is doubled using colchicine and it becomes a hexaploid *Triticale* ( $2n = 42$ ).

The cycle of crop raising and selection continues till the plants with the desired characters are finally obtained. The development of new varieties is a long-drawn process. Two main aspects of hybridization are to combine the characters of two plants in one plant and to utilize hybrid vigour.

## 20.4 Animal Breeding

A **breed** is a group of animals of common origin within a species that has certain distinguishing characters that are not found in other members of the same species like general appearance and others striking features.

**Breeding** involves mating parents of different varieties each having some desired trait which are passed onto the offspring.

### Objectives of Animal Breeding

**Animal breeding** aims at improving the genotypes of domesticated animals to increase their yield and improve the desirable qualities to produce milk, egg and meat.

When breeding takes place between animals of the same breed, it is called **inbreeding**. The cross between different breeds is called **outbreeding**.

#### 20.4.1 Inbreeding

Inbreeding refers to the **mating of closely related animals within the same breed** for about 4-6 generations. Superior males and superior females of the same breed are identified and mated in pairs. It helps in the accumulation of superior genes and elimination of genes which are undesirable.

*Hissardale* is a new breed of sheep developed in Punjab by crossing Bikaneri (Magra) ewes and Australian Marino rams.

**Inbreeding depression:** Continued inbreeding reduces fertility and productivity. Inbreeding exposes harmful recessive genes that are eliminated by selection.

#### 20.4.2 Outbreeding

It is the **breeding of unrelated animals**. The offsprings formed are called hybrids. The **hybrids** are stronger and vigorous than their parents. Cross between two different species with desirable features of economic value are mated. Let's see what cross produce a mule.

##### Cross breeding

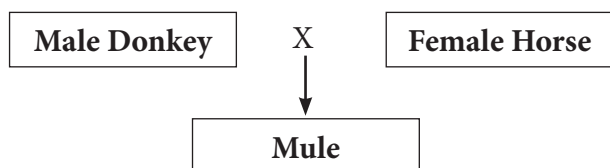

Mule is superior to horse in strength, intelligence, ability to work and resistance to diseases but they are sterile.

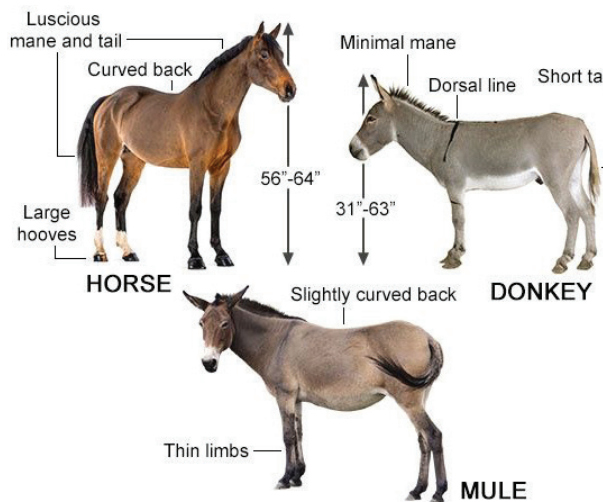

Figure 20.6 Cross breeding to produce Mule with superior characters

#### Info bits

##### Cross breed of fowls:

White Leghorn X Plymouth Rock



Hybrid fowl - yield more eggs

##### Cross breed of cows:

Developed by mating the bulls of exotic breeds and cows of indigenous breeds.

Brown Swiss X Sahiwal



Karan Swiss - yield 2-3 times more milk than indigenous cows.

#### 20.4.3 Heterosis

The superiority of the hybrid obtained by cross breeding is called as **heterosis** or **hybrid vigour**.

##### Effects of hybrid vigour in animal breeding

- Increased production of milk by cattle
- Increased production of egg by poultry
- High quality of meat is produced
- Increased growth rate in domesticated animals

## 20.5 Genetic Engineering

Genetic engineering is the manipulation and transfer of genes from one organism to another organisms to create a new DNA called as **recombinant DNA (rDNA)**. The term recombinant is used because DNA from two different sources can be joined together. Hence, genetic engineering is also called as **recombinant DNA technology**.



**DO YOU KNOW?**

Plasmid is the small circular double stranded DNA molecule found in the cytoplasm of bacterial cell and separated from chromosomal DNA. It can replicate independently.

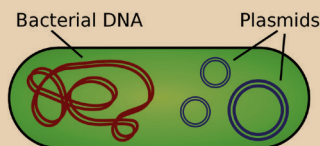

### More to Know

**Restriction enzymes** recognises a specific base pair sequence (palindromic sequence) in DNA called as restriction site and cleaves the phosphodiester bond within DNA.

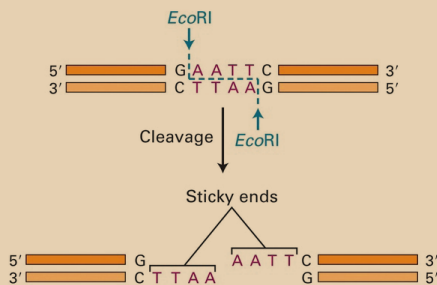

### 20.5.1 Techniques of Genetic Engineering – Basic Requirements

Important discoveries that led to the stepping stone of rDNA technology were

- Presence of **plasmid** in bacteria that can undergo replication independently along with chromosomal DNA.
- Restriction enzymes** cuts or break DNA at specific sites and are also called as molecular scissors.
- DNA ligases** are the enzymes which help in ligating (joining) the broken DNA fragments.

### 20.5.2 Gene Cloning

What reminds to your mind when you hear the word clone? Of course, ‘DOLLY’ the cloned sheep. The carbon copy of an individual is often called a **clone**. However, more appropriately, a clone means to make a **genetically exact copy of an organism**.

In gene cloning, a gene or a piece of DNA fragment is inserted into a bacterial cell where DNA will be multiplied (copied) as the cell divides. A brief outline of the basic steps involved in gene cloning are:

- Isolation of desired DNA fragment by using restriction enzymes
- Insertion of the DNA fragment into a suitable vector (Plasmid) to make rDNA
- Transfer of rDNA into bacterial host cell (Transformation)
- Selection and multiplication of recombinant host cell to get a clone
- Expression of cloned gene in host cell.

Using this strategy several enzymes, hormones and vaccines can be produced

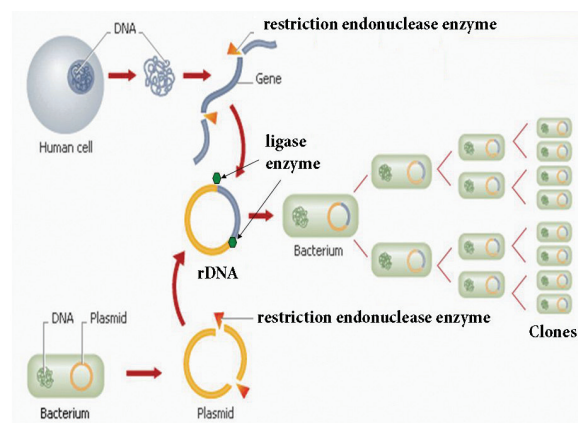
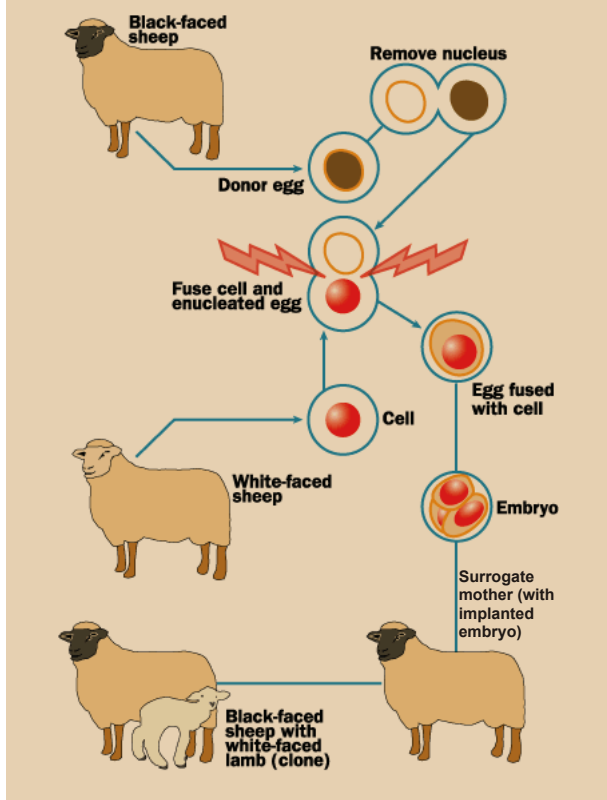

**Figure 20.7** Genetic engineering technique (Gene cloning)

**Info bits**

**Development of Dolly**

Dolly was the first cloned female sheep, developed by Dr. Ian Wilmut and his colleagues at the Roslin Institute, Scotland in July 1996. She was created by somatic cell nuclear transfer technique. She lived for 6.5 years and died in 2003 because of lung disease.



- d. Tissue plasminogen activator is used to dissolve blood clots and prevent heart attack.
- e. Development of vaccines against various diseases like Hepatitis B and rabies



Eli Lilly and Company, United States, in 1979 first started commercial production of human insulin by using rDNA technology.

**Gene Therapy**

Gene therapy refers to the replacement of defective gene by the direct transfer of functional genes into humans to treat genetic disease or disorder. The genetic makeup of the 'patient' cell is altered using recombinant DNA technology. It was first successfully implemented in 1990.

**Somatic gene therapy** is the replacement of defective gene in somatic cells.

**Germ line gene therapy** replacement of defective gene in germ cell (egg and sperm).

Gene therapy conducted till date has targeted only somatic (non-reproductive) cells. Correction of genetic defects in somatic cells may be beneficial to the patient but the corrected gene may not be carried to the next generation.

**20.6 Biotechnology in Medicine**

Using genetic engineering techniques medicinally important valuable proteins or polypeptides that form the potential pharmaceutical products for treatment of various diseases have been developed on a commercial scale.

**Pharmaceutical products developed by rDNA technique**

- a. Insulin used in the treatment of diabetes.
- b. Human growth hormone used for treating children with growth deficiencies.
- c. Blood clotting factors are developed to treat haemophilia.

**20.7 Stem Cells**

Our body is composed of over 200 specialised cell types, that can carry out specific functions. e.g. neurons or nerve cell that can transmit signals, or heart cells which contract to pump blood or pancreatic cells to secrete insulin. These specialised cells are called as **differentiated cells**.

In contrast to differentiated cells, stem cells are **undifferentiated or un specialised** mass of cells. The stem cells are the cells of

variable potency. Potency refers to the number of possible fates that a cell can acquire. The two important properties of stem cells that differentiate them from other cells are:

- i. its ability to divide and give rise to more stem cells by self-renewal
- ii. its ability to give rise to specialised cells with specific functions by the process of differentiation.

### Types of stem cells

**Embryonic stem cells** can be extracted and cultured from the early embryos. These cells are **derived from the inner cell mass of blastocyst**. These cells can be developed into any cell in the body.

**Adult stem cell** or **somatic stem cell** are found in the neonatal (new born) and adults. They have the ability to divide and give rise to specific cell types. Sources of adult stem cells are amniotic fluid, umbilical cord and bone marrow.

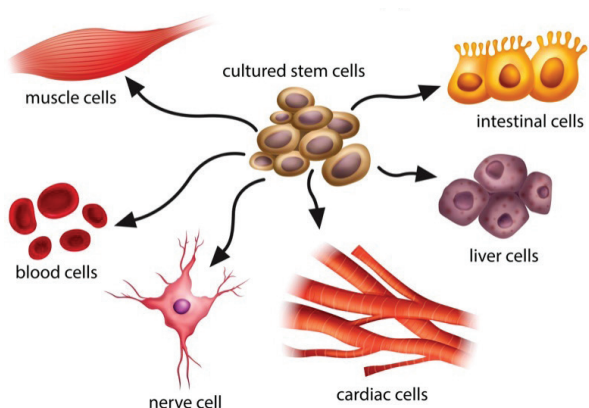

Figure 20.8 Differentiation of stem cells

### Stem-cell therapy

Sometimes cells, tissues and organs in the body may be permanently damaged or lost due to genetic condition or disease or injury. In such situations stem cells are used for the treatment of diseases which is called **stem-cell therapy**. In treating **neurodegenerative disorders** like

Parkinson’s disease and Alzheimer’s disease **neuronal stem cells** can be used to replace the damaged or lost neurons.

## 20.8 DNA Fingerprinting Technology

The human genome has 3 billion base pairs. Did you know that the DNA pattern of two individuals cannot be same except for identical twins. Each person’s DNA sequence is unique due to the small difference in the base pairs. Therefore, if we want to compare the genetic difference among the two individuals, **DNA fingerprinting** is the easier and quicker method. This technique was developed by **Alec Jeffrey**.

The technique analyses each individual’s unique DNA sequences and provides distinctive characteristics of individual which helps in identification. **Variable number of tandem repeat sequences (VNTRs)** serve as molecular markers for identification.

In human beings, 99 % of the DNA base sequences are the same and this is called as bulk genomic DNA. The remaining 1 % DNA sequence differs from one individual to another. This 1 % DNA sequence is present as small stretch of repeated sequences which is known as **satellite DNA**. The number of copies of the repeat sequence also called as **VNTRs** differs from one individual to another, and results in variation in the size of the DNA segment.

Person 1	..GCCAGCTAGCTAGCTAGCTAGCTAGCTTTCAT..
	1 2 3 4 5 6
Person 2	..GCCAGCTAGCTAGCTAGCTAGCTTTCAT..
	1 2 3 4 5
Person 3	..GCCAGCTAGCTAGCTAGCTAGCTAGCTAGCTT..
	1 2 3 4 5 6 7

### VNTRs illustration of three persons

As shown in the illustration, the sequence AGCT is repeated six times in first person, five times in second person and seven times in third

person. Because of this, DNA segment of third person will be larger in size followed by DNA segment of first person and then the second person. Thus, it is clear that satellite DNA bring about variation within the population. Variation in DNA banding pattern reveals differences among the individuals.

**Applications of DNA Fingerprinting**

- i. DNA fingerprinting technique is widely used in forensic applications like crime investigation such as identifying the culprit. It is also used for paternity testing in case of disputes.
- ii. It also helps in the study of genetic diversity of population, evolution and speciation.

**20.9 Genetically Modified Organisms (GMOs)**

One of the most tremendous development of genetic engineering is the production of

genetically modified (GM) plants and animals. **Genetic modification** refers to the alteration or manipulation of genes in the organisms using rDNA techniques in order to produce the desired characteristics. The DNA fragment inserted is called **transgene**. Plants or animals expressing a modified endogenous gene or a foreign gene are also known as **transgenic organisms**.

The transgenic plants are much stable, with improved nutritional quality, resistant to diseases and tolerant to various environment conditions. Similarly transgenic animals are used to produce proteins of medicinal importance at low cost and improve livestock quality.

Some examples of genetically modified plants and animals are given in the table below.

**Genetically Modified Plants**

Objective	Gene inserted	Achievement
Improved nutritional quality in Rice	Beta carotene gene (In humans, Beta carotene is required for the synthesis of Vitamin A)	<b>Golden Rice</b> (Genetically modified rice can produce beta carotene, that can prevent Vitamin A deficiency)
Increased crop production	Bt gene from bacteria <i>Bacillus thuringiensis</i> . (Bt gene produces a protein that is toxic to insects)	<b>Insect resistant plants</b> (These plants can produce the toxin protein that kills the insects which attack them)

**Genetically Modified Animals**

Objective	Gene inserted	Achievement
Improved wool quality and production	Genes for synthesis of amino acid, cysteine	<b>Transgenic sheep</b> (gene expressed)
Increased growth in fishes	Salmon or Rainbow trout or Tilapia growth hormone gene	<b>Transgenic fish</b> (gene expressed)

**Points to Remember**

- ❖ Crop improvement is the development of improved crop varieties possessing higher yield, better quality, resistance to diseases and shorter duration.
- ❖ When breeding takes place between animals of the same breed, it is called inbreeding. The cross between different breeds is called outbreeding.
- ❖ The superiority of the hybrid obtained by cross breeding is called as heterosis or hybrid vigour.
- ❖ Genetic engineering is the manipulation and transfer of genes from one organism to another organism.
- ❖ Stem cells are undifferentiated or unspecialised mass of cells and can be used for the treatment known as stem cell therapy.



**TEXTBOOK EVALUATION**



**I Choose the correct answer**

1. Which method of crop improvement can be practised by a farmer if he is inexperienced?
  - a. clonal selection      b. mass selection
  - c. pureline selection    d. hybridisation
2. Pusa Komal is a disease resistant variety of \_\_\_\_\_.
  - a. sugarcane              b. rice
  - c. cow pea                d. maize
3. Himgiri developed by hybridisation and selection for disease resistance against rust pathogens is a variety of \_\_\_\_\_.
  - a. chilli                    b. maize
  - c. sugarcane              d. wheat
4. The miracle rice which saved millions of lives and celebrated its 50th birthday is \_\_\_\_\_.
  - a. IR 8    b. IR 24    c. Atomita 2    d. Ponni
5. Which of the following is used to produce products useful to humans by biotechnology techniques?
  - a. enzyme from organism
  - b. live organism
  - c. vitamins
  - d. both (a) and (b)
6. We can cut the DNA with the help of
  - a. scissors      b. restriction endonucleases
  - c. knife         d. RNAase
7. rDNA is a
  - a. vector DNA
  - b. circular DNA
  - c. recombinant of vector DNA and desired DNA
  - d. satellite DNA
8. DNA fingerprinting is based on the principle of identifying ----- sequences of DNA
  - a. single stranded      b. mutated
  - c. polymorphic         d. repetitive
9. Organisms with modified endogenous gene or a foreign gene are also known as
  - (a) transgenic organisms
  - (b) genetically modified
  - (c) mutated
  - (d) both a and b



10. In a hexaploid wheat(  $2n = 6x = 42$  ) the haploid (n) and the basic(x) number of chromosomes respectively are
- a.  $n = 7$  and  $x = 21$       b.  $n = 21$  and  $x = 21$   
 c.  $n = 7$  and  $x = 7$         d.  $n = 21$  and  $x = 7$

**II Fill in the blanks**

- Economically important crop plants with superior quality are raised by\_\_\_\_\_.
- A protein rich wheat variety is \_\_\_\_\_.
- \_\_\_\_\_is the chemical used for doubling the chromosomes.
- The scientific process which produces crop plants enriched with desirable nutrients is called \_\_\_\_\_.
- Rice normally grows well in alluvial soil, but \_\_\_\_\_ is a rice variety produced by mutation breeding that grows well in saline soil.
- \_\_\_\_\_ technique made it possible to genetically engineer living organism.
- Restriction endonucleases cut the DNA molecule at specific positions known as \_\_\_\_\_.
- Similar DNA fingerprinting is obtained for \_\_\_\_\_.
- \_\_\_\_\_ cells are undifferentiated mass of cells.
- In gene cloning the DNA of interest is integrated in a \_\_\_\_\_.

**III State whether true or false. If false, write the correct statement**

- Raphano brassica* is a man-made tetraploid produced by colchicine treatment.
- The process of producing an organism with more than two sets of chromosome is called mutation.
- A group of plants produced from a single plant through vegetative or asexual reproduction are called a pureline.

- Iron fortified rice variety determines the protein quality of the cultivated plant
- Golden rice is a hybrid.
- Bt gene from bacteria can kill insects.
- In vitro fertilisation* means the fertilisation done inside the body.
- DNA fingerprinting technique was developed by Alec Jeffrey.
- Molecular scissors refers to DNA ligases.

**IV Match the following**

Column A	Column B
1. Sonalika	<i>Phaseolus mungo</i>
2. IR 8	Sugarcane
3. Saccharum	Semi-dwarf wheat
4. Mung No. 1	Ground nut
5. TMV – 2	Semi-dwarf Rice
6. Insulin	<i>Bacillus thuringiensis</i>
7. Bt toxin	Beta carotene
8. Golden rice	first hormone produced using rDNA technique

**V Understand the assertion statement, justify the reason given and choose the correct choice**

- Assertion is correct and reason is wrong
  - Reason is correct and the assertion is wrong
  - Both assertion and reason is correct
  - Both assertion and reason is wrong.
- Assertion:** Hybrid is superior than either of its parents.  
**Reason:** Hybrid vigour is lost upon inbreeding.
  - Assertion:** Colchicine reduces the chromosome number.  
**Reason:** It promotes the movement of sister chromatids to the opposite poles.
  - Assertion:** rDNA is superior over hybridisation techniques.

**Reason:** Desired genes are inserted without introducing the undesirable genes in target organisms.

**VI Answer in a sentence**

1. Give the name of wheat variety having higher dietary fibre and protein.
2. Semi-dwarf varieties were introduced in rice. This was made possible by the presence of dwarfing gene in rice. Name this dwarfing gene.
3. Define genetic engineering.
4. Name the types of stem cells.
5. What are transgenic organisms?
6. State the importance of biofertiliser.

**VII Short answers questions**

1. Discuss the method of breeding for disease resistance.
2. Name three improved characteristics of wheat that helped India to achieve high productivity.
3. Name two maize hybrids rich in amino acid lysine
4. Distinguish between
  - a. somatic gene therapy and germ line gene therapy
  - b. undifferentiated cells and differentiated cells
5. State the applications of DNA fingerprinting technique.
6. How are stem cells useful in regenerative process?
7. Differentiate between outbreeding and inbreeding.

**VIII Long answers questions**

1. What are the effects of hybrid vigour in animals.

2. Describe mutation breeding with an example.
3. Biofortification may help in removing hidden hunger. How?
4. With a neat labelled diagram explain the techniques involved in gene cloning.
5. Discuss the importance of biotechnology in the field of medicine.

**IX Higher Order Thinking Skills (HOTS)**

1. A breeder wishes to incorporate desirable characters into the crop plants. Prepare a list of characters he will incorporate
2. Organic farming is better than Green Revolution. Give reasons
3. Polyploids are characterised by gigantism. Justify your answer.
4. 'P' is a gene required for the synthesis of vitamin A. It is integrated with genome of 'Q' to produce genetically modified plant 'R'.
  - i. What is P, Q and R?
  - ii. State the importance of 'R' in India.



**REFERENCE BOOKS**

1. Chaudhari, H.K., Elementary Principles of Plant Breeding, 2<sup>nd</sup> Edition.
2. Dubey, R.C., A Text book of Biotechnology. 5<sup>th</sup> Edition. S. Chand and Company Pvt. Ltd. New Delhi.



**INTERNET RESOURCES**

- <https://www.embibe.com/study/transgenic-cow-rosie-concept>
- [https://en.wikipedia.org/wiki/DNA\\_profiling](https://en.wikipedia.org/wiki/DNA_profiling)
- <https://www.krishijagran.com/news/tomato-at-shoots-potato-in-roots>

## Concept Map

### Plant Breeding

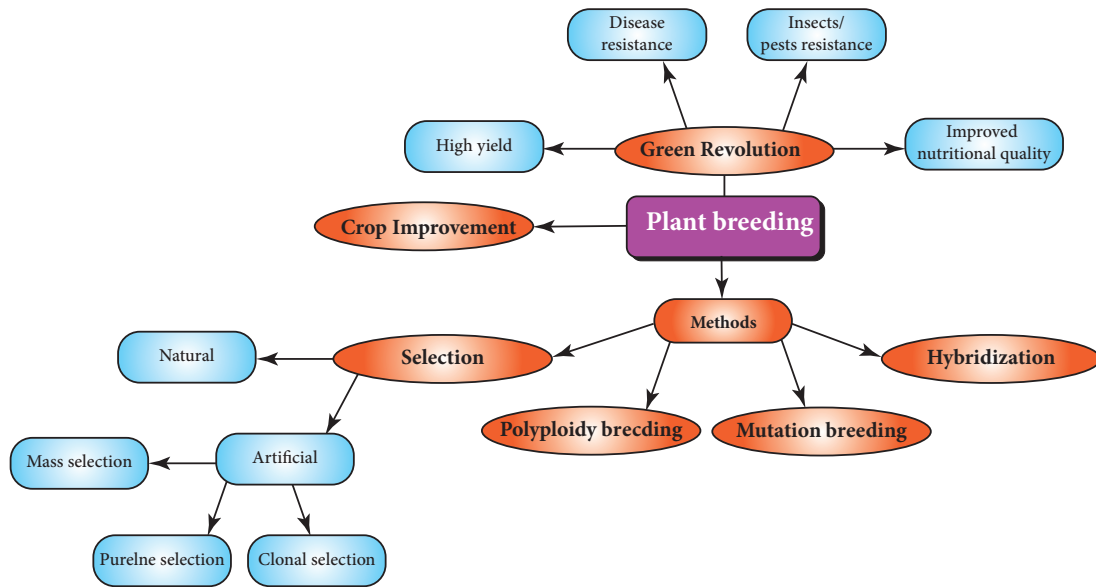

### Animal Breeding and Biotechnology

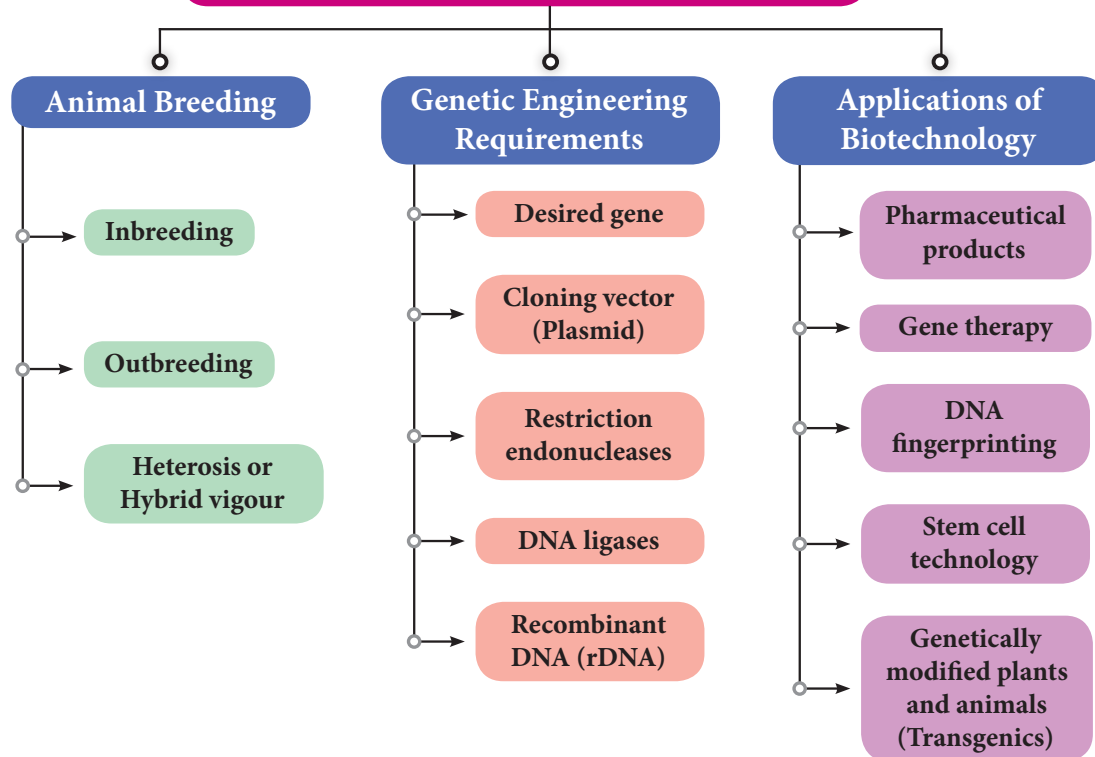



# HEALTH AND DISEASES



## Learning Objectives



At the end of this lesson the students will be able to:

- ◆ Understand the types of abuses and associated behavioural changes.
- ◆ Gain knowledge of prevention and protection from child sexual abuse.
- ◆ Know the causes for drug, tobacco and alcohol addiction and its effects on health.
- ◆ Analyse the possible ways of de-addiction.
- ◆ Know about the diseases and disorders associated with lifestyle modification.
- ◆ Compare the features of Type-1 and Type-2 diabetes mellitus and relates the signs and symptoms.
- ◆ Explain the underlying cause and symptoms for obesity, heart disease, cancer and AIDS.
- ◆ Suggest remedial measures for prevention and control of these diseases and disorders.
- ◆ To create awareness among the individuals in the society to lead healthy life.

## Introduction

Abuses occur in a variety of forms and are deeply rooted in cultural, social and economic practices. Solving this global problem however requires a much better understanding of its occurrence, causes and consequences with context to sexual and childhood abuse, this is followed by substance abuse. Are people leading healthier lives in today's modern world than their generations did in the past? For instance, smoking cigarettes, alcohol addiction, use of drugs, eating high fat and cholesterol rich diets, excessive intake of junk foods, reduced physical activity are some of the risk factors for illness and early death. The role of behaviour in health has been receiving increased attention in countries around the

world. The health habits of the individuals and their behaviour influence the development of chronic and fatal diseases such as diabetes, obesity, heart disease, cancer and AIDS. These conditions can be substantially reduced by adopting lifestyles that promote wellness and protect their health by taking nutritious diet, regular exercise and by avoiding drugs, alcohol and smoking.

### 21.1 Abuse and Types of Abuse

**Abuse** refers to cruel, violent, harmful or injurious treatment of another human being. It includes **physical, emotional or psychological, verbal, child** and **sexual** abuses. Abuse can occur within the family and with people who are not associated with the family.

These days the use of drugs, alcohol and tobacco has been increasing especially among teenagers and adolescents for adventure, excitement, curiosity and experimentation.

Let's analyse some of the consequences of sexual and childhood abuse, its prevention and protection.

### 21.1.1 Child Abuse

Child abuse constitutes all forms of physical or emotional ill treatment, sexual abuse, **exploitation** resulting in child's ill health, survival and development. **Physical abuse** of a child is defined as those acts that cause physical harm such as threatening, beating, kicking and hitting the child.

### 21.1.2 Sexual Abuse

Sexual harassment is a form of power and dominance of one person over another, which can result in harmful consequence to

the victim. It refers to inappropriate or forced sexual contact. Adolescent girls and women encounter sexual harassment in different forms. Sexual abuse is more common at work places. Verbal remarks, comments, gestures and looks are the most common forms of abuse. This results in psychological distress, physical illness and eating disorders in the affected individuals.

### 21.1.3 Child Sexual Abuse

Children are considered soft targets for sexual abuse because they may not realize that they are being abused. Commonly, abusers are persons well known to the child, may even be living in the same locality. Abusers also bribe (use chocolates and toys) to lure children and take advantage of the child's innocence.

Sexually abused children show symptoms of genital injury, abdominal pain, frequent urinary infection and behavioural problems.

#### More to Know

The Ministry of Women and Child Development championed the introduction of the Protection of Children from Sexual Offences (POCSO) Act, 2012. People who traffic children for sexual purposes are also punishable under the provisions relating to the Act.



#### Objectives of the POCSO Act, 2012

- ◆ To protect children from the offences of
  - Sexual assault
  - Sexual harassment
  - Pornography
- ◆ To establish Special Courts for speedy trial of such offences.

### 21.1.4 Approaches for Protection of an Abused Child

Measures adopted for monitoring and assessment of abused child who have undergone signs and symptoms of distress are:

**Child Helpline:** The Child Helpline provides a social worker who can assist the child by providing food, shelter and protection.

**Counselling the child:** Psychologists and social workers should provide guidance, counselling and continuous support to a victimized child.

**Family support:** The victimized child should be supported by the family members. They should be provided with proper care and attention to overcome their sufferings.

**Medical care:** A child victim of sexual offences should receive medical care and treatment from health care professionals to overcome mental stress and depression.

**Legal Counsel:** The family or the guardian of the child victim shall be entitled to free assistance of a legal counsel for such offence.

**Rehabilitation:** Enrolling in schools and resuming their education is an important step towards rehabilitation of the child. It is essential that the child's life is gradually returned to normal after the incidence of abuse.

**Community based efforts:** Conducting awareness campaign on child abuse and its prevention.

- ◆ Not to receive money, toys, gifts or chocolates from known or unknown person to them without the knowledge of their parents.
- ◆ Not to allow known or unknown person to touch them.

It is the responsibility of every individual living in a society to ensure a safe and protected environment for our children to enable them to live with dignity and free from any form of violence.

### More to Know

The National Commission for Protection of Child Rights (NCPCR) was set up in March 2007 under the Commissions for Protection of Child Rights (CPCR) Act, 2005. This act emphasizes the principle of universality and inviolability of child rights and recognizes the tone of urgency in all the child related policies of the country.

Protection of all children of all age group upto 18 years of age is of equal importance. Policies define priority actions for the most vulnerable children.



CHILD HELPLINE 1098



## 21.2 Drug, Alcohol and Tobacco Abuse

The physical and mental dependency on alcohol, smoking and drugs is called addiction. The addictive potential of these substances pulls an individual



into a **vicious cycle** leading to **regular abuse and dependency**. This is of serious concern because abuse of tobacco, alcohol or drugs produce many harmful effects in an individual, to the family and even to the society. This dangerous behavior pattern among youth can be prevented through proper guidance.

## 21.3 Drug Abuse

Drugs are normally used for the treatment of disease on advice of a physician and withdrawn after recovery. A person who is habituated to a drug due to its prolonged use is called **drug addict**. This is called **drug addiction** or **drug abuse**.

A drug that modifies the physical, biological, psychological or social behaviour of a person by stimulating, depressing or disturbing the functions of the body and the mind is called **addictive drug**. These drugs interact with the

### Prevention of child sexual abuse

The most important social policy proclaimed universally is the prevention of child abuse. Taking steps to prevent childhood sexual abuse is parental and institutional responsibility. Instructions to be given by parents and teachers to the child are.

- ◆ Do not talk to any suspected person or strangers and to maintain a distance.
- ◆ Not to be alone with unknown person.
- ◆ To be careful while travelling alone in public or private transport.

central nervous system and affect the individual physically and mentally.

### 21.3.1 Types of Drugs

There are certain drugs called **psychotropic drugs** which acts on the brain and alter the behaviour, consciousness, power of thinking and perception. They are referred as **mood altering drugs**.

### 21.3.2 Drug Dependence

Persons who consume these drugs become fully dependent on them, they cannot live without drugs. This condition is referred as **drug dependence**.

- **Physical and mental dependence**  
Dependence on the drug for normal condition of well being and to maintain physiological state.
- **Psychological dependence** is a feel that drugs help them to reduce stress.

**DO YOU KNOW?**

- ◆ International Day against Drug Abuse and Illicit Trafficking - June 26.
- ◆ Narcotic Drugs and Psychotropic Substances Act was introduced in 1985.

### 21.3.3 Behavioural Changes of Drug Users

Adverse effects of drug use among adolescents are

- Drop in academic performance, absence from school or college.
- Lack of interest in personal hygiene, isolation, depression, fatigue and aggressive behaviour.
- Deteriorating relationship with family and friends.
- Change in food and sleeping habits.

- Fluctuation in body weight and appetite
- Always looking out for an easy way to get money for obtaining drugs.
- Prone to infections like AIDS and Hepatitis-B.

**DO YOU KNOW?** World Health Organization (WHO) 1984 suggested the use of the term drug dependence in place of drug addiction or drug abuse

### 21.3.4 Drug De-addiction

Management of de-addiction is a complicated and difficult task. The path to recovery of drug addicts is long and often slow.

Family members, friends and society on the whole have a very important role to play.



**Detoxification:** The first phase of treatment is detoxification. The drug is stopped gradually and the addict is helped to **overcome the withdrawal symptoms**. The addict undergoes severe physical and emotional disturbance. This is taken care by specific medication.

**Psychotherapy:** Individual and group counselling is given by psychologists and counsellors. The treatment includes efforts to reduce the addict's stress, taught new ways to solve everyday's problems, adequate diet, rest and relaxation.

**Counselling to family members:** Social workers counsell family members in order to change the **attitude of rejection** so that the addict is accepted by the family and the society.

**Rehabilitation:** They are given proper **vocational training** so that they can lead a healthy life and become useful members of the society.

## 21.4 Tobacco Abuse

Tobacco is obtained from the tobacco plant *Nicotiana tabacum* and *Nicotiana rustica*. The dried and cured leaves of its young branches make the commercial tobacco used worldwide. Addiction to tobacco is due to ‘**nicotine**’ an alkaloid present in it. Nicotine is a **stimulant**, highly harmful and poisonous substance.

### 21.4.1 Tobacco Use

Tobacco is used for smoking, chewing and snuffing. Inhaling tobacco smoke from cigars, cigarettes, bidis, pipes, hukka is called **smoking**. Tobacco in powder form is **chewed** with pan. When powdered tobacco is taken through nose, it is called **snuffing**.

### 21.4.2 Smoking Hazards and Effects of Tobacco

When smoke is inhaled, the chemicals get absorbed by the tissues and cause the following harmful effects

- (i) **Benzopyrene** and **polycyclic hydrocarbons** present in tobacco smoke is carcinogenic causing lung cancer.
- (ii) Causes inflammation of throat and bronchi leading to conditions like **bronchitis** and **pulmonary tuberculosis**.
- (iii) Inflammation of lung alveoli, decrease surface area for gas exchange and cause **emphysema**.
- (iv) **Carbon monoxide** of tobacco smoke binds to haemoglobin of RBC and decreases its oxygen carrying capacity causing **hypoxia** in body tissues.
- (v) **Increased blood pressure** caused by smoking leads to increased risk of heart disease.
- (vi) Causes **increased gastric secretion** which leads to gastric and duodenal ulcers.
- (vii) Tobacco chewing causes **oral cancer** (mouth cancer).

### Info bits

World Health organization (WHO) 1984 suggested the use of the term drug. WHO issued a directive under which all cigarette advertisements and packs carry a statutory warning “**Smoking is injurious to Health**”.

### Activity 1

Collect pictures of people affected by tobacco chewing and tobacco smoking. Identify which part of the body is affected and the health hazards it can lead to.

### 21.4.3 Prevention of Smoking

Knowing the dangers of smoking and chewing tobacco adolescents and the old people need to avoid these habits. Proper counselling and medical assistance can help an addict to give up the habit of smoking.

### More to Know

Anti Tobacco Act was passed on May 1<sup>st</sup> 2004. By 2030 tobacco is expected to be single biggest cause of death worldwide accounting for 10 million deaths per year.

May 31<sup>st</sup> is observed as No Tobacco Day (World Anti-Tobacco Day)



International  
**NO-TOBACCO DAY**

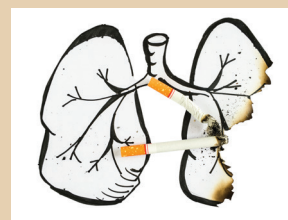



## 21.5 Alcohol Abuse

The consumption of alcohol is a social evil practiced by the wealthier and poorer sections of the society. The dependence of alcohol is called **alcoholism** and the addict is termed as **alcoholic**. It is called **alcohol abuse**. Drinking of alcohol impairs one's physical, physiological and psychological functions.

### Activity 2

Collect pictures of individuals with normal liver and alcoholic liver, compare and indicate the changes you find in them.

#### 21.5.1 Harmful Effects of Alcohol to Health

Prolonged use of alcohol depresses the nervous system, by acting as a sedative and analgesic substance. Some of the harmful effects are

- Nerve cell damage resulting in various mental and physical disturbances
- Lack of co-ordination of body organs
- Blurred or reduced vision, results in road accidents
- Dilation of blood vessels which may affect functioning of the heart
- Liver damage resulting in fatty liver which leads to cirrhosis and formation of fibrous tissues
- Body loses its control and consciousness eventually leading to health complications and ultimately to death

#### ALCOHOL: HOW DRINKING AFFECTS YOUR BODY

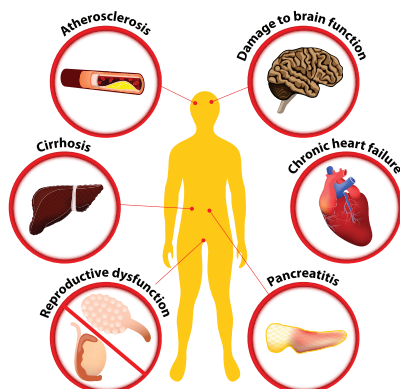

## 21.6 Rehabilitation Measures for Alcoholics

**Education and counselling:** Education and proper counselling will help the alcoholics to overcome their problems and stress, to accept failures in their life.

**Physical activity:** Individuals undergoing rehabilitation should be channelized into healthy activities like reading, music, sports, yoga and meditation.

**Seeking help from parents and peer groups:** When a problematic situation occurs, the affected individuals should seek help and guidance from parents and peers. This would help them to share their feeling of anxiety, wrong doing and get rid of the habit.

**Medical assistance:** Individual should seek help from psychologists and psychiatrists to get relieved from this condition and to lead a relaxed and peaceful life.

Alcohol de-addiction and rehabilitation programmes are helpful to the individual so that they could get rid of the problem completely and can lead a normal and healthy life.

## 21.7 Diseases and Disorders due to Lifestyle Modifications

Diseases are prevalent in our society due to our improper way of living, conditions of stress and strain. These diseases are non-communicable and affect the person who are suffering from particular symptoms. It is an impairment of the body tissue or organ, disturbances in metabolic function which require modification of an individual's normal life.

## 21.8 Diabetes Mellitus

Diabetes mellitus is a chronic metabolic disorder. In Greek (Diabetes – running through; mellitus- sweet). It is characterised

by increased blood glucose level due to insufficient, deficient or failure of insulin secretion. This is the most common pancreatic endocrine disorder. The incidence of Type-1 and Type-2 diabetes is increasing worldwide.

### 21.8.1 Type-1 Insulin Dependent Diabetes Mellitus (IDDM)

IDDM accounts for 10 to 20% of the known diabetics. The condition also occurs in children (**juvenile onset diabetes**) and **young adults**, the onset is usually sudden and can be life threatening. This is caused by the **destruction of  $\beta$ -cells of the pancreas**. It is characterized by abnormally elevated blood glucose levels (**hyperglycemia**) resulting from **inadequate insulin secretion**.

**Causes:** Genetic inheritance and environmental factors (infections due to virus, acute stress) are the cause for this condition.

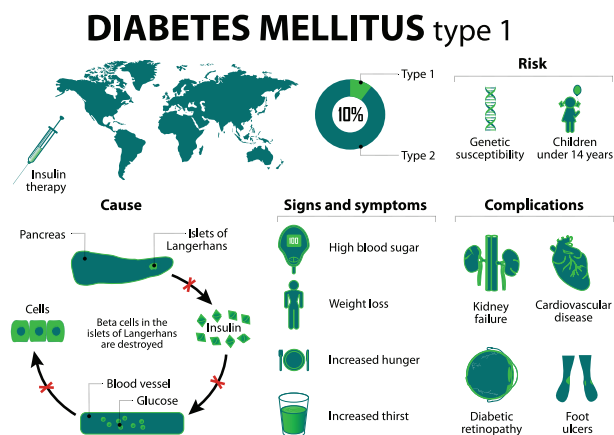

### 21.8.2 Type-2 Non-Insulin Dependent Diabetes Mellitus (NIDDM)

This is also called as **adult onset diabetes** and accounting for 80 to 90% of the diabetic population. It develops slowly, usually milder and more stable. **Insulin production by the pancreas is normal** but its **action is impaired**. The target cells do not respond to insulin. It does not allow the movement of glucose into cells.

**Causes:** The causes are multifactorial which include increasing age (affecting middle

aged and older people), obesity, sedentary life style, overeating and physically inactive.

#### More to Know

One in every 8 individuals in India is a diabetic. The revised WHO estimates for the year 2025 is 57.2 million diabetics in India. The average age for the onset of diabetes is 40 years, while it is 55 years in other countries. World Health Organization projects that diabetes will be 7<sup>th</sup> leading cause of death by the year 2030.

**Symptoms:** Diabetes mellitus is associated with several metabolic alterations. The most important symptoms are

- Increased blood glucose level (**Hyperglycemia**)
- Increased urine output (**Polyuria**) leading to dehydration
- Loss of water leads to thirst (**Polydipsia**) resulting in increased fluid intake
- Excessive glucose excreted in urine (**Glycosuria**)
- Excess hunger (**Polyphagia**) due to loss of glucose in urine.
- Fatigue and loss of weight



According to WHO recommendation, if the fasting blood glucose is greater than 140 mg/dl or the random blood glucose is greater than 200 mg /dl on more than two occasions, diagnosis for confirming diabetes is essential.

### 21.8.3 Prevention and Control of Diabetes

Diet, hypoglycemic drugs, insulin injection and exercise are the management options based on the type and severity of the condition. The overall goal of diabetes management is to maintain normal blood glucose level.

**Table 21.1** Differences between Type-1 and Type-2 Diabetes Mellitus

Factors	Type-1 Insulin dependent diabetes mellitus (IDDM)	Type-2 Non-insulin dependent diabetes mellitus (NIDDM)
Prevalence	10-20%	80-90%
Age of onset	Juvenile onset (< 20 years)	Maturity onset (>30 years)
Body weight	Normal or Underweight	Obese
Defect	Insulin deficiency due to destruction of $\beta$ -cells	Target cells do not respond to insulin
Treatment	Insulin administration is necessary	Can be controlled by diet, exercise and medicine

**Dietary management:** Low carbohydrate and fibre rich diets are more appropriate. Carbohydrates should be taken in the form of starch and complex sugars. Refined sugars (sucrose and glucose) should be avoided. Diet comprising whole grains, millets (jowar, bajra, ragi), green leafy vegetables, wheat and unpolished rice should be included in diet regularly.

Carbohydrates is maintained to about 50-55% of the total calories. High protein content of 10-15% of the total intake is required to supply essential amino acids. Fat content in the diet should be 15-25% of the total calories. Saturated fat intake should be reduced. Polyunsaturated fatty acid content should be higher.

**Management with insulin:** Commercially available insulin preparations (short and long acting) are also used to maintain blood glucose levels.

**Physical activity:** Exercise plays an important role in facilitating a good control of diabetes, in addition to strengthening and toning up the muscles.

**Education and Awareness:** People with diabetics should be educated on the nature of disease they have and the possibility of complications of the disease, if blood sugar is not kept under control. Instructions regarding diet, exercise and drugs should be explained.

**Info bits**

Flax seeds containing insoluble fibre, Guavas, Tomatoes and Spinach are foods which help reduce blood sugar levels.

**21.9 Obesity**

Obesity is the state in which there is an accumulation of excess body fat with an **abnormal increase in body weight**. Obesity is a complex multifactorial chronic disease developing from influence of social, behavioural, psychological, metabolic and cellular factors.

Obesity occurs if intake of calories is more than the expenditure of energy. Over weight and obesity are conditions where the body weight is greater than the mean standard weight for age and height of an individual. Body mass index (BMI) is an estimate of body fat and health risk.

$$\text{BMI} = \text{Weight (kg)} / \text{Height (m)}^2$$

**More to Know**

Every 7 calories of excess consumption leads to 1 gm fat deposit and increase in body weight. Weight due to fat in adipose tissue exceeds more than 20% to 25 % of body weight. An adult weighing 10% more than the standard weight is OVERWEIGHT and 20% more is OBESE.

**Causes and risk factors:** Obesity is due to genetic factors, physical inactivity, eating habits (overeating) and endocrine factors. Obesity is a positive risk factor in development of hypertension, diabetes, gall bladder disease, coronary heart disease and arthritis.

### 21.9.1 Prevention and Control of Obesity

**Diet Management:** Low calorie, normal protein, vitamins and mineral, restricted carbohydrate and fat, high fiber diet can prevent overweight. Calorie restriction for weight reduction is safe and most effective.

**Physical exercise:** A low calorie diet accompanied by moderate exercise will be effective in causing weight loss. Meditation, yoga and physical activity can also reduce stress related to overeating.

## 21.10 Heart Disease

Cardiovascular disease (CVD) is associated with diseases of the heart and blood vessels. **Coronary heart disease (CHD)** is the most common form and is caused by **deposition of cholesterol in the blood vessels.**

It usually develops slowly over many years beginning from childhood, they may form a fatty streak to a fibrous complicated **plaque.** It leads to the narrowing of blood vessels leading to **atherosclerosis** in the large and medium sized arteries that supply the heart muscle with oxygen. It leads to sudden **ischemia** (deficient blood supply to heart muscle) and **myocardial infarction** (death of the heart muscle tissue).

### More to Know

Desirable level for blood cholesterol should be less than 200 mg/dl for Indians. The risk of coronary heart disease increases slowly as blood cholesterol levels increases from 200 to 300 mg/dl.

**Risk factors:** Hypercholesterolemia (High blood cholesterol) and high blood pressure (Hypertension) are the major causes and contributing factors for heart disease and if untreated may cause severe damage to brain, kidney and eventually lead to stroke.

**Causes:** Heredity (family history), diet rich in saturated fat and cholesterol, obesity, increasing age, cigarette smoking, emotional stress, sedentary lifestyle, excessive alcohol consumption and physical inactivity are some of the causes.

**Symptoms:** Shortness of breath, headache, tiredness, dizziness, chest pain, swelling of leg, and gastrointestinal disturbances.



**HDL** (High Density Lipoprotein) or "good" cholesterol lowers risk of heart disease while **LDL** (Low Density Lipoprotein) or "bad" cholesterol increases risk of heart disease.

### 21.10.1 Prevention and Control of Heart Disease

**Diet management:** Reduction in the intake of calories, low saturated fat and cholesterol rich food, low carbohydrates and common salt are some of the dietary modifications. Diet rich in polyunsaturated fatty acids (PUFA) is essential. Increase in the intake of fibre diet, fruits and vegetables, protein, minerals and vitamin are required.

**Physical activity:** Regular exercise, walking and yoga are essential for body weight maintenance

**Addictive substance avoidance:** Alcohol consumption and smoking are to be avoided.

### Activity 3

Prepare a chart showing the food items which are preferable and which should be avoided to prevent high blood pressure and heart disease. Apart from diet what are the other lifestyle modifications to be followed to manage this condition.

## 21.11 Cancer

Cancer causes about 4 million deaths annually throughout the world. In India more than one million people suffer from cancer. Cancer is derived from Latin word meaning crab. The study of cancer is called **Oncology** (**Oncos- Tumor**).

Cancer is an abnormal and uncontrolled division of cells that invade and destroy surrounding tissue forming a tumor or **neoplasm** (new growth). It is a heterogenous group of cells that do not respond to the normal cell division.

The cancerous cells migrate to distant parts of the body and affect new tissues. This process is called **metastasis**. The frequent sites of metastasis are lungs, bones, liver, skin and brain.

### More to Know

World Cancer Day - 4<sup>th</sup> February

National Cancer Awareness Day - 7<sup>th</sup> November

### 21.11.1 Types of Cancers

Cancers are classified on the basis of the tissues from which they are formed.

1. **Carcinomas** arise from **epithelial** and **glandular tissues**. They include cancers of skin, lung, stomach and brain. About 85% of the tumours are carcinomas
2. **Sarcomas** are occur in the **connective** and **muscular tissue**. They include the cancer of bones, cartilage, tendons, adipose tissue and muscles. These form 1% of all tumours.

### More to Know

#### Types of Tumours

**Benign tumours or Non malignant tumours:** Remain confined in the organ affected and do not spread to other parts of the body.

**Malignant tumours:** Mass of proliferating cells which grow very rapidly invading and damaging the surrounding normal tissues.

3. **Leukaemia** are characterized by an increase in the formation of white blood cells in the bone marrow and lymph nodes. Leukaemia are called **blood cancers**. Most common type of cancer which also affect children below 15 years of age.

### 21.11.2 Carcinogenic Agents

Cancer causing agents are called **carcinogens**. They are physical, chemical agents, ionizing radiations and biological agents.

**Physical Irritant:** Heavy smoking causes lung cancer and cancers of oral cavity, pharynx (throat) and larynx. Betel and tobacco chewing causes oral cancer. Excessive exposure to sunlight may cause skin cancer.

**Chemical agents:** Nicotine, caffeine, products of combustion of coal and oil, pesticides, asbestos, nickel, certain dyes and artificial sweeteners induce cancer.

**Radiations:** Ionizing radiations like X-rays, gamma- rays, radioactive substances and non-ionising radiations like UV rays cause DNA damage leading to cancer.

**Biological agents:** Cancer causing viruses are called oncogenic viruses.

### 21.11.3 Treatment of Cancer

The treatment of cancer involves the following methods:

**Surgery:** Tumours are removed by surgery to prevent further spread of cancer cells.

**Radiation therapy:** Tumour cells are irradiated by lethal doses of radiation while protecting the surrounding normal cells.

**Chemotherapy:** It involves administration of anticancerous drugs which prevent cell division and are used to kill cancer cells.

**Immunotherapy:** Biological response modifiers like interferons are used to activate the immune system and help in destroying the tumors.

### 21.11.4 Preventive measures for Cancer

Cancer control programmes should focus on primary prevention and early detection.

To prevent lung cancer tobacco smoking is to be avoided and protective measures to be taken against exposure to toxic pollutants of industries. Excessive exposure to radiation is to be avoided to prevent skin cancer.

## 21.12 AIDS (Acquired Immunodeficiency Syndrome)

AIDS is a severe viral disease and caused by Human Immunodeficiency Virus (HIV). It is a condition in which immune system fails and **suppress the body's disease fighting mechanism**. They **attack the lymphocytes** and the affected individual is prone to infectious diseases.



Dr. Suniti Solomon, pioneered HIV research and treatment in India. She set up the first voluntary testing and counselling centre and an AIDS Research group in Chennai during 80's. Her team was the first to document evidence of HIV infection in India in 1985 (First Indian AIDS patient in Chennai).

### 21.12.1 Transmission of HIV

AIDS virus has been found in urine, tears, saliva, breast milk and vaginal secretions. The virus is transmitted by an infected patient who comes in contact with blood of a healthy person. HIV/AIDS is not transmitted by touch or any physical contact. It spreads through contact of body fluids or blood.

HIV is transmitted generally by

- (i) Sexual contact with infected person
- (ii) Use of contaminated needles or syringes especially in case of intravenous drug abusers

- (iii) By transfusion of contaminated / infected blood or blood products
- (iv) From infected mother to her child through placenta.

### 21.12.2 Symptoms and Treatment of AIDS

**Symptoms:** Infected individuals become immunodeficient. The person becomes more susceptible to viral, bacterial, protozoan and fungal infections. Swelling of lymph nodes, damage to brain, loss of memory, lack of appetite and weight loss, fever, chronic diarrhoea, cough, lethargy, pharyngitis, nausea and headache.

**Diagnosis:** The presence of HIV virus can be confirmed by **Western Blot** analysis or **Enzyme Linked Immunosorbent Assay (ELISA)**

**Treatment:** Anti-retroviral drugs and immunostimulative therapy can prolong the life of the infected person.

### 21.12.3 Prevention and Control of AIDS

The following steps may help in controlling and prevent the spreading of HIV infection

- (i) Screening of blood from blood banks for HIV before transfusion.
- (ii) Ensuring the use of disposable needles and syringes in hospitals and clinics.
- (iii) Advocating safe sex and advantages of using condoms.
- (iv) Creating awareness campaign and educating people on the consequences of AIDS.
- (v) Persons with HIV/AIDS should not be isolated from the family and society.



**More to Know**

Many people are ignorant about AIDS and it has been said that – “don’t die of ignorance”. In our country NACO (National AIDS Control Organization) and other NGO’S (Non- Governmental Organizations) are educating people about AIDS. Every year December 1<sup>st</sup> is observed as the “World AIDS Day”.

**Points to Remember**

- ◆ Use of certain drugs by an individual as a regular habit. This is called drug addiction or drug abuse.
- ◆ Tobacco is used for smoking, chewing and snuffing. Inhaling tobacco smoke is called smoking.
- ◆ The dependence of alcohol is called alcoholism and the addict is termed as alcoholic.
- ◆ Prolonged use of alcohol depresses the nervous system, by acting as a sedative and analgesic substance and causes fatty liver (cirrhosis).
- ◆ Diabetes mellitus is a chronic metabolic disorder. It is characterised by increased blood glucose level due to insufficient, deficient or failure of insulin secretion and insulin resistance.
- ◆ Obesity is the state in which there is an accumulation of excess body fat with an abnormal increase in body weight.
- ◆ Coronary heart disease is the most common form and is caused by deposition of cholesterol in the blood vessels.
- ◆ Cancer is an abnormal and uncontrolled division of cells that invade and destroy surrounding tissue forming a tumor or neoplasm.
- ◆ AIDS is caused by Human immunodeficiency virus.



**TEXTBOOK EVALUATION**



**I. Choose the correct answer**

1. Tobacco consumption is known to stimulate secretion of adrenaline. The component causing this could be
  - a) Nicotine                      b) Tannic acid
  - c) Curcumin                    d) Leptin
2. World 'No Tobacco Day' is observed on
  - a) May 31                        b) June 6
  - c) April 22                      d) October 2
3. Cancer cells are more easily damaged by radiations than normal cells because they are
  - a) Different in structure
  - b) Non-dividing
  - c) Mutated Cells
  - d) Undergoing rapid division
4. Which type of cancer affects lymph nodes and spleen?
  - a) Carcinoma                    b) Sarcoma
  - c) Leukemia                     d) Lymphoma
5. Excessive consumption of alcohol leads to
  - a) Loss of memory
  - b) Cirrhosis of liver
  - c) State of hallucination
  - d) Supression of brain function
6. Coronary heart disease is due to
  - a) *Streptococci* bacteria
  - b) Inflammation of pericardium
  - c) Weakening of heart valves
  - d) Insufficient blood supply to heart muscles
7. Cancer of the epithelial cells is called
  - a) Leukemia                      b) Sarcoma
  - c) Carcinoma                    d) Lipoma

8. Metastasis is associated with
  - a) Malignant tumour    b) Benign tumour
  - c) Both (a) and (b)    d) Crown gall tumour
9. Polyphagia is a condition seen in
  - a) Obesity                      b) Diabetes mellitus
  - c) Diabetes insipidus    d) AIDS
10. Where does alcohol effect immediately after drinking?
  - a) Eyes                      b) Auditory region
  - c) Liver                      d) Central nervous system

2. A highly poisonous chemicals derived from tobacco is \_\_\_\_\_
3. Blood cancer is called \_\_\_\_\_.
4. Less response of a drug to a specific dose with repeated use is called \_\_\_\_\_
5. Insulin resistance is a condition in \_\_\_\_\_diabetes mellitus

**II. State whether True or False, if false write the correct statement**

1. AIDS is an epidemic disease.
2. Cancer causing genes are called Oncogenes.
3. Obesity is characterized by tumour formation.
4. In leukemia both WBCs and RBCs increase in number.
5. Study of cause of disease is called etiology.
6. AIDS is not transmitted by contact with a patient's clothes.
7. Type 2 diabetes mellitus results due to insulin deficiency.
8. Carcinogens are cancer causing agents.
9. Nicotine is a narcotic drug.
10. Cirrhosis is associated with brain disorder.

**VI. Analogy type questions. Identify the first words and their relationship and suggest a suitable word for the fourth blank**

1. Communicable: AIDS: Non communicable: \_\_\_\_\_
2. Chemotherapy: Chemicals: Radiation therapy: \_\_\_\_\_
3. Hypertension: Hypercholesterolemia: Glycosuria: \_\_\_\_\_

**III. Expand the following abbreviations**

1. IDDM    2. HIV    3. BMI
4. AIDS    5. CHD    6. NIDDM

**VII. Answer in a sentence**

1. What are psychotropic drugs ?
2. Mention the diseases caused by tobacco smoke.
3. What are the contributing factors for Obesity?
4. What is adult onset diabetes?
5. What is metastasis?
6. How does insulin deficiency occur?

**IV. Match the following**

1. Sarcoma	-	Stomach cancer
2. Carcinoma	-	Excessive thirst
3. Polydipsia	-	Excessive hunger
4. Polyphagia	-	Lack of blood flow to heart muscle
5. Myocardial Infarction	-	Connective tissue cancer

**VIII. Short answer questions**

1. What are the various routes by which transmission of human immuno deficiency virus takes place ?
2. How is a cancer cell different from a normal cell ?
3. Differentiate between Type-1 and Type-2 diabetes mellitus
4. Why is a dietary restriction recommended for an obese individual ?
5. What precautions can be taken for preventing heart diseases ?

**V. Fill in the blanks**

1. Cirrhosis is caused in liver due to excessive use of \_\_\_\_\_

**IX. Long answer questions**

1. Suggest measures to overcome the problems of an alcoholic.



- Changes in lifestyle is a risk factor for occurrence of cardiovascular diseases. Can it be modified? If yes, suggest measures for prevention.

### X. Higher Order Thinking Skills (HOTS)

- What is the role of fat in the cause of atherosclerosis?
- Eating junk food and consuming soft drinks results in health problems like obesity, still children prefer. What are the suggestions you would give to avoid children eating junk food/ consumption of soft drinks?
- Regular physical exercise is advisable for normal functioning of human body. What are the advantages of practising exercise in daily life?
- A leading weekly magazine has recently published a survey analysis which says that number of AIDS patient in the country is increasing day by day. The report says that the awareness among the people about AIDS is still very poor. You are discussing the magazine report in your class and a team of your class decides to help people to fight against the dreadful disease.
  - What problem you face when trying to educate the people in your village near by your school?
  - How do you overcome the problem?

### XI. Value based questions

- Once a person starts taking drugs or alcohol it is difficult to get rid of the habit. Why?
- Men addicted to tobacco lead to oxygen deficiency in their body. What could be the possible reason?
- Name any three foods that are to be avoided and included in the diet of a diabetic patient. Why should it be followed?
- How can informational efforts change people's HIV knowledge and behaviour?

### XII. Assertion and Reasoning

In each of the following questions, a statement of Assertion is given and a corresponding statement of Reason is given just below it. Of statements given below mark the correct answer as

- If both Assertion and Reason are true and Reason is the correct explanation of Assertion
- If both Assertion and Reason are true that Reason is not the correct explanation of Assertion
- Assertion is true but Reason is false
- Both Assertion and Reason are false

- Assertion:** All drugs act on the brain.  
**Reason:** Drugs disturb the functioning of the body and mind.
- Assertion:** Excretion of excess glucose in urine is observed in a person with diabetes mellitus.  
**Reason:** Pancreas is unable to produce sufficient quantity of insulin.



### REFERENCE BOOKS

- Edward P Sarafino and Timothy W. Smith. 2012, Health Psychology, International Student Version - 7<sup>th</sup> Edition, Wiley India (P) Ltd, New Delhi.
- Srilakshmi, B. Dietetics, 2014, 7<sup>th</sup> Multi-color Edition, New Age International Publishers, New Delhi.
- Sathyanarayana U. Biochemistry – Revised Edition, Books and (P) Ltd, Kolkata.



### INTERNET RESOURCES

- <http://www.rossandwilson.com/lecturers>  
<https://www.elsevier.com/health>  
<https://www.ncpcr.gov.in>

## Concept Map

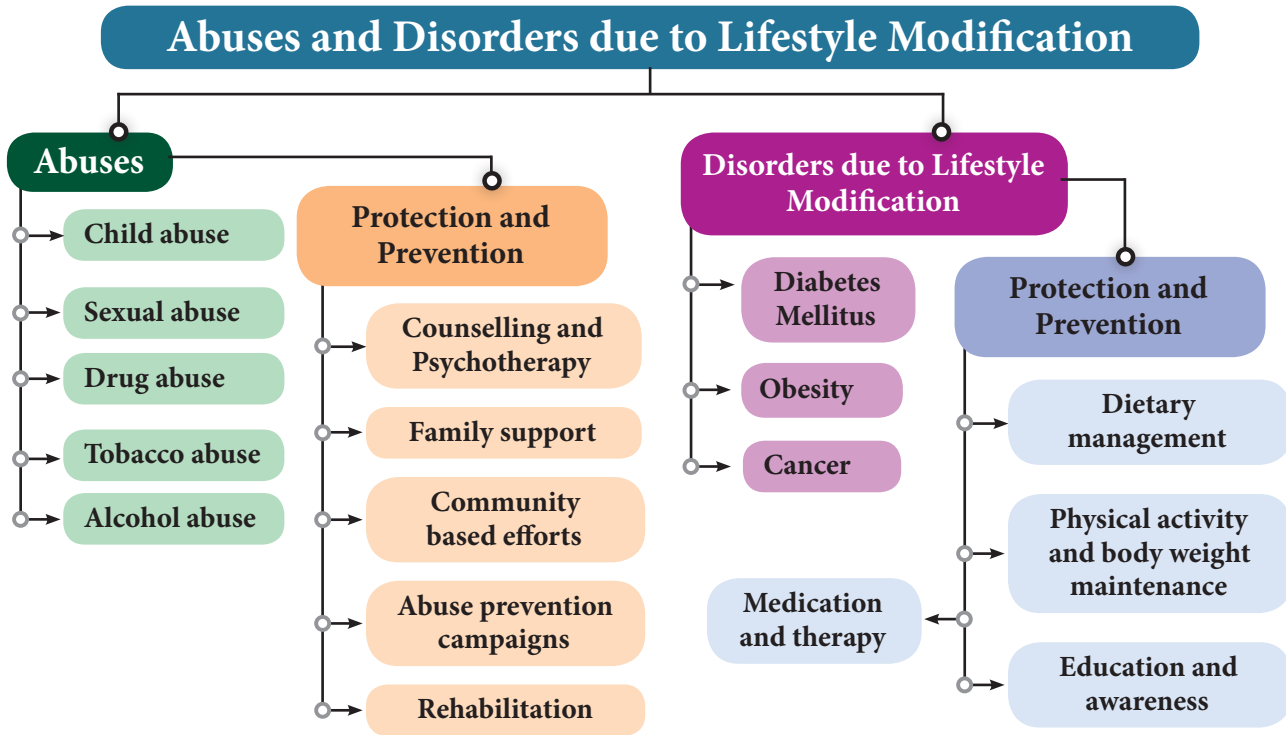

 UNIT  
22

 ENVIRONMENTAL MANAGEMENT

## Learning Objectives

At the end of this lesson the students will be able to:

- ◆ Differentiate between renewable and non-renewable resources.
- ◆ Gain knowledge about the need for conservation of various natural resources.
- ◆ To know the various methods which can be adopted of conservation of natural resources.
- ◆ Create awareness about the limited exploitation of natural resources.
- ◆ Get motivated to participate in the protection of environment and its management.



## Introduction

Environmental management deals with the different aspects of environment, its structure, function, its quality and its maintenance including conservation of its living and non-living components. The diversified natural resources on this earth provide the necessities for survival of all forms of life including man. Everything that comes from nature has some utility for man but its utilization is possible based on the availability of appropriate technology.

Resources can be renewed simultaneously along with their exploitation (forests, crops, wildlife, groundwater, wind and solar energy). They can maintain themselves by natural recycling or can be replenished by proper management. Simultaneously, non-renewable resources cannot be recycled and can get exhausted by unlimited and continuous use (mineral ores, coal, petroleum etc). They cannot be replaced easily. This would lead to a

situation where non-renewable resources may come to an end after a certain period of time.

Expanding human population resulted in expanding needs of man. With scientific and technological advancement man started utilizing natural resources at a much larger scale. Continuous increase in population caused an increased demand for resources. Therefore, conservation of natural resources makes important contributions to the social and economic development of the country.

### 22.1 Conservation and Judicious Use of Resources

Natural resources are conserved for their biological, economic and recreational values. The use of natural resources in excess and unplanned way leads to imbalance in the environment. A judicious balance should be maintained between exploitation of resources and its replenishment. Proper utilization and

management of nature and its resources is termed as **conservation**.

We have to build a sustainable world, which should last forever. Some of the ways to sustain continuous use of resources are practices to utilise energy efficiently, avoid wastage of water, avoid usage of plastics and other non-biodegradable materials and to take care for the environment we live. It is important that we manage and use our resources carefully so as to preserve for the future generations.

## 22.2 Forest and its Importance

Forests are an important component of our environment and are dominated by microorganisms, flowering plants, shrubs, climbers, dense trees and provide a vast habitat for wild animals. Forests also contribute to the economic development of our country. Forests are vital for human life, it is a source for a wide range of **renewable natural resource**. They provide wood, food, fodder, fibre and medicine.

Forests are major factor of environmental concern. They act as carbon sink, regulate climatic conditions, increase rainfall, reduce global warming, prevent natural hazards like flood and landslides, protect wildlife and also act as catchments for water conservation. They also play a vital role in maintaining the ecological balance.

### 22.2.1 Deforestation and its Effects

Deforestation is the destruction of large area of forests. This happens for many reasons like intensive agriculture, urbanization, construction of dams, roads, buildings and industries, hydroelectric projects, forest fires, construction of mountain and forest roads. It is a threat to the economy, quality of life and future of the environment. India is losing about 1.5 million hectares of forest cover every year.

### More to Know

#### Chipko movement

The Chipko movement was a non-violent agitation in 1973 that was aimed at protection and conservation of trees. The name of the movement 'Chipko' comes from the word 'embrace', as the villagers hugged the trees and encircled them to prevent them from being cut. The movement originated in the Chamoli district of Uttar Pradesh (now Uttarakhand). The protest of Chipko movement achieved a major victory in 1980 with a 15 year ban on cutting trees in the Himalayan forests.

### Effects of Deforestation

Deforestation gives rise to ecological problems like floods, drought, soil erosion, loss of wild life, extinction of species, imbalance of biogeochemical cycles, alteration of climatic conditions and desertification.

### 22.2.2 Conservation of Forests

India has an area of 752.3 lakh hectare classified as **reserved forests** and 215.1 lakh hectare as **protected forests**. The important measures taken for conservation of forests are as follows

**Afforestation:** Activities for afforestation programme (**Van Mahotsav**) includes planting and protecting trees with multiple uses which help in restoration of green cover. Destruction of trees should be curtailed.

**Social forestry programme:** It should be undertaken on a large scale with active participation of the public and utilization of common land to produce firewood, fodder and timber for the benefit of the rural community. This relieves pressure on existing forests and to safeguard future of tribals.

**Forest Conservation through Laws:** Adopting stringent laws and policies to conserve and protect forests are through National Forest Policy, (1952 and 1988) and Forest Conservation Act, 1980.

## 22.3 Wildlife and its Conservation

Wild life refers to the undomesticated animals living in their natural habitats (forests, grasslands and deserts) an area without human habitation. They are needed for maintaining biological diversity. It also helps in promoting economic activities that generates revenue through tourism. Conservation of forest and wildlife is interrelated with each other.

### 22.3.1 Decline in Wildlife Population

Wildlife of India is a great natural heritage. Exploitation of wildlife resources has decreased global wildlife population by 52% between 1970 and 2014. Over exploitation and shrinking of forest cover areas has resulted in animals becoming extinct, some are threatened and some are on the verge of extinction. In recent years, increase in human encroachment has posed a threat to India's wildlife.

### 22.3.2 Aims of Wildlife Management

The main aim of wildlife conservation are:

- To control and limit exploitation of species.
- To preserve the plants and animals from extinction.
- Maintenance of threatened species and protect species which are on the verge of extinction.
- Preserve the endangered species.
- To study the ecological relationship of the plants and animals in natural habitat.
- Hunting and poaching should be prohibited.
- Establishment of National parks, Wildlife sanctuaries, protected areas and Biosphere reserves.

The **Wildlife protection Act** was established in 1972. The provisions of the act are

- Prohibit killing and hunting of specified animals.
- Constitute sanctuaries, national parks, and closed areas for wildlife conservation.
- Special schemes for preservation of endangered species.
- Constitute Central Zoo Authority and recognition of zoos.
- Restrict, regulate or prohibit trade in wild animals and products obtained from them.



- Jim Corbett National Park was the first to be established in 1936 in Uttarakhand, India.
- There are 15 biosphere reserves in India.
- The Nilgiris is a biosphere reserve in Tamil Nadu.

### 22.3.4 Organisations Involved in Conservation of Wildlife

- Indian Board for WildLife (IBWL)
- World Wildlife Fund (WWF) for Nature
- World Conservation Union (WCN)
- International Union for Conservation of Nature and Natural resources (IUCN)
- Convention of International Trade in Endangered Species (CITES)
- Bombay Natural History Society (BNHS)
- Wild life Preservation Society of India, Dehradun



Rathika Ramasamy, a native of Venkatachalapuram village, Theni District in Tamil Nadu was the first Indian woman to strike an International reputation as wildlife photographer. Her passion is towards bird photography. A photobook on wildlife titled "The best of wildlife moments" was published in November 2014.



## Info bits

**Wildlife Conservation Initiatives In India.**

- ◆ Project Tiger and Project Elephant has been launched in 1973 and 1992 respectively
- ◆ Crocodile Conservation Project was launched in 1976.
- ◆ Sea Turtle Conservation Project was launched in 1999.
- ◆ Indian Rhino Vision 2020 is to conserve at least 3000 greater one-horned rhinos in Assam, India by 2020.

**22.4 Soil Erosion**

The top layers of soil contain humus and mineral salts, which are vital for the growth of plants. Removal of **upper layer of soil** by wind and water is called soil erosion. Soil erosion causes a significant loss of humus, nutrients and decrease the fertility of soil.

**22.4.1 Agents of Soil Erosion**

Agents of soil erosion are high velocity of wind, air currents, flowing water, landslide, human activities (deforestation, farming and mining) and overgrazing by cattle.

**22.4.2 Management of Soil Erosion**

- ◆ Retain vegetation cover, so that soil is not exposed.
- ◆ Cattle grazing should be controlled.
- ◆ Crop rotation and soil management improve soil organic matter.
- ◆ Runoff water should be stored in the catchment.
- ◆ Reforestation, terracing and contour ploughing.
- ◆ Wind speed can be controlled by planting trees in form of a shelter belt.

**22.5 Renewable and Non-Renewable Energy Resources**

Energy is an important input for development. The expansion of possible energy resources has been directly related with the pace of agricultural and industrial development in every part of the world. Energy resources can be classified as non-renewable and renewable.

**Non-renewable (Exhaustible) energy resources**

Energy obtained from sources **that cannot renew themselves** over a short period of time is known as non-renewable energy. These are available in limited amount in nature. They include coal, petroleum, natural gas and nuclear power. These **conventional energy resources** account for 90% of the world's production of commercial energy and nuclear power account for 10%.

**Renewable (Inexhaustible) energy resources**

These energy resources are available in unlimited amount in nature and they can be **renewed over a short period of time**, inexpensive and can be harvested continuously. These comprise the vast potential of **non-conventional energy resources** which include biofuel, biomass energy, geothermal energy, water energy (hydroelectric energy and tidal energy), solar energy, wave energy and wind energy.

**22.5.1 Fossil Fuels**

Fossil fuels are found inside the earth's crust and are energy rich substances formed by natural process, such as **anaerobic decomposition of buried dead organisms**, over millions of years. As the accumulating sediment layers produce heat and pressure, the remains of the organisms are gradually transformed into hydrocarbons. e.g. petroleum, coal and natural gas.

### 22.5.2 Coal and Petroleum

Coal and Petroleum are **natural resources**. They are called **fossil fuels** as they are formed from the degradation of biomass buried deep under the earth millions of years ago.



India is the third largest consumer of crude oil in the world, after the United States and China.

**Coal** is used for **generation of electricity** at Thermal power plants. **Petroleum** also known as **crude oil** is processed in oil refineries to produce **petrol** and **diesel** which are used to run automobiles, trucks, trains, ships and airplanes etc. **Kerosene** and **LPG** (Liquefied Petroleum Gas) obtained from petroleum is used as domestic fuel for cooking food.

The coal and petroleum reserves can get exhausted if we continue using them at a rapid rate. The formation of these fossil fuels is a very slow process and takes very long period of time for renewal.

### 22.5.3 Steps to Conserve Coal and Petroleum Resources

It is necessary to conserve or save coal and petroleum resources for the future use, which can be done by reducing their consumption.

- (i) If electricity is saved, it will inturn reduce the use of coal
- (ii) Using bicycle for covering short distances instead of using cars, scooters or motorcycles
- (iii) Using pressure cooker can reduce the consumption of kerosene and LPG while cooking food. Solar cooker and solar heaters can be used wherever possible
- (iv) Motor vehicles should be designed with fuel efficient engines to increase efficiency and also reduce air pollution

### Case study of Taj Mahal

The Taj Mahal is one of the seven wonders of the world and is located in Agra, Uttarpradesh. It is built with white marble. The Mathura oil refinery owned by Indian Oil Corporation present around this area produce sulphur and nitrogen oxides. The white marble became yellow due to air pollution. The Government of India has set up emission standards around the monument to protect it from the damage.

### 22.6 Non-Conventional (Alternative) Energy Resources

The energy crisis has shown that for sustainable development in energy sector we must conserve the non-renewable conventional resources from its rapid depletion and replace them by non-polluting, renewable sources which are environmentally clean.

Efforts are made to develop new sources of energy which is called non-conventional sources of energy. It would provide greater initiative to local people who could assess their needs and resources and plan a strategy that could be useful to them.

#### 22.6.1 Solar Energy

Solar energy is the **energy obtained from the sun**. The sun gives out vast amount of light and heat. It is only a little less than half (47%) of solar energy which falls on the atmosphere reaches the earth's surface. If we could use just a small part of this energy it would fulfill all the country's need for power. Solar energy has advantages and also certain limitations.



#### Solar Energy Devices

The energy from the sun can be harnessed to provide power. The various devices used for harnessing sun's energy are called solar energy devices.

### Solar Cells

Solar cells (Photovoltaic devices) is made up of silicon that **converts sunlight directly into electricity**. Solar cell produces electricity without polluting the environment. Since it uses no fuel other than sunlight, no harmful gases, no burning and no wastes are produced. These can be installed in remote and inaccessible areas (forests and hilly regions) where setting up of power plant is expensive.

#### Uses of Solar cells

- (i) It can be used for street lighting, traffic signals, water pumping, battery charging system etc.
- (ii) It is used in artificial satellites and space probes
- (iii) It provides radio and TV transmission to remote areas
- (iv) It is used in calculators, electronic toys and watches.

### Solar Panel

Arrangement of many solar cells side by side connected to each other is called solar panel. The capacity to provide electric current is much increased in the solar panel. But the process of manufacture is very expensive.



Figure 22.1 Solar Panel

### Solar Cooker

It consist of an insulated metal box or wooden box which is painted from inside so as to absorb maximum solar radiations. A thick glass sheet forms the cover over the



Solar Cooker

box. The reflector is the plane mirror which is attached to the box. The food is cooked by energy radiated by the sun.

### Solar thermal power plant

In solar thermal power plants, many solar panels are used to concentrate sun rays, to heat up water into steam. The steam is used to run the turbines to produce electricity.



A capacity of 100 litres solar heater can save upto 1500 units of electricity per year.

### Advantages of Solar Energy

- (i) It is available in abundance in our country and is free of cost.
- (ii) It is a renewable source of energy.
- (iii) It can be used for generating electricity or heat.
- (iv) It does not cause pollution.

### 22.6.2 Biogas

Biogas is the mixture of methane (nearly 75 %), hydrogen sulphide, carbon dioxide and hydrogen. It is produced by the **decomposition of animal wastes** (cow dung) and plant wastes in the absence of oxygen. It is also commonly called as 'Gobar gas' since the starting material used is cow dung which means gobar in Hindi.

#### Uses of biogas

- (i) It is used as fuel for cooking .
- (ii) It is used to run motors and pump sets.
- (iii) It is used to generate electricity.

#### Advantages of biogas

- (i) It burns without smoke and therefore causes less pollution.
- (ii) An excellent way to get rid of organic wastes like bio-waste and sewage material.
- (iii) Left over slurry is a good manure rich in nitrogen and phosphorus
- (iv) It is safe and convenient to use
- (v) It can reduce the amount of greenhouse gases emitted.



### 22.6.3 Shale gas

Shale refers to the **soft finely stratified sedimentary rock** that is formed from the compaction of small old rocks containing mud and minerals – such as quartz and calcite, trapped beneath earth's surface. These rocks contain fossil fuels like oil and gas in their pores.

The fuel is extracted by a technique called **hydraulic fracturing** (drilling or well boring of sedimentary rocks layers to reach productive reservoir layers).

#### Environmental concerns of shale gas

- (i) Shale drilling could affect groundwater reserves, which can contaminate the drinking water resources and also affect the fertility of the soil.
- (ii) Million gallons of water is needed to break and release the shale gas, which in turn can affect the water table.

#### More to Know

India has identified six basins as areas for shale gas exploration: Cambay (Gujarat), Assam-Arakan (North East), Gondwana (Central India), Krishna Godavari onshore (East Coast), Cauvery onshore and Indo-Gangetic basins.

### 22.6.4 Wind Energy

The **kinetic energy** possessed by the wind is due to its high speed, that can be **converted into mechanical power by wind turbines**. The rotatory motion of wind mill produces wind energy. It can be used for generating electricity, run water pumps, flour mills, draw water from wells etc.,



- ◆ The world's largest and tallest wind turbine is situated in Hawaii.
- ◆ One wind turbine can produce electricity for 300 homes.

### Windmill

Windmill is a machine that converts the energy of wind into rotational energy by broad blade attached to the rotating axis. When the blowing air strikes the blades of the windmill, it exerts force and causes the blades to rotate. The rotational movement of the blades operate the generator and the electricity is produced. The energy output from each windmill is coupled together to get electricity on a commercial scale.



Figure 22.2 Windmill

#### Advantages of Wind energy

- (i) Wind energy is free, eco-friendly, renewable source of energy.
- (ii) It does not cause pollution.
- (iii) Expenses on periodic maintenance is low when compared to the other power sources.

#### Activity 1

Collect information regarding the

- (i) Tehri Dam project
- (ii) Sardar Sarovar Dam project

### 22.6.5 Water Energy

Earth's surface is covered with nearly 71% of water. **Harnessing the energy from the flowing water** can be used to produce electricity. The technique to harness the **water energy** is called **Hydropower**.

The electrical energy is derived from water flow, water falling from a height. Hilly areas are suitable for this purpose where there is continuous flow of water in large amounts falling from high slopes. It does not cause environmental pollution or waste generation.

**Hydropower plants** converts the kinetic energy of flowing water into electricity. This is called hydroelectricity.

### 22.6.6 Tidal Energy

Tidal energy is the **energy obtained from the movement of water due to ocean tides**. Tides are the rise and fall of sea levels caused by the combined effects of the gravitational forces exerted on the oceans of the earth.

A tidal stream is a fast flowing body of water created by tides. Turbines are placed in tidal streams. When the tides hit the turbine, the turbine rotates and converts the tidal energy into electric energy

#### Advantages of tidal energy

- (i) Tidal energy does not produce any pollution.
- (ii) It does not use any fuel and does not produce any waste.
- (iii) Tides are predictable, so tidal energy can be produced at any time.
- (iv) Water is denser than air and therefore can generate electricity at lower speeds than wind turbines.

## 22.7 Rainwater Harvesting

Rainwater harvesting is a technique of **collecting and storing rainwater** for future use. It is a traditional method of storing rain water in underground tanks, ponds, lakes, check dams and used in future.

The main purpose of rainwater harvesting is to make the rainwater percolate under the ground so as to recharge '**groundwater level**'.

#### Methods of rainwater harvesting

- (i) **Roof top rainwater harvesting:** Roof-tops are excellent **rain catchers**. The rain water that falls on the roof of the houses, apartments, commercial buildings etc. is collected and stored in the surface tank and can be used for domestic purpose.

- (ii) **Recharge pit:** In this method, the rainwater is first collected from the roof tops or open spaces and is directed into the **percolation pits** through pipes for filtration. After filtration the rainwater enters the **recharge pits** or **ground wells**.

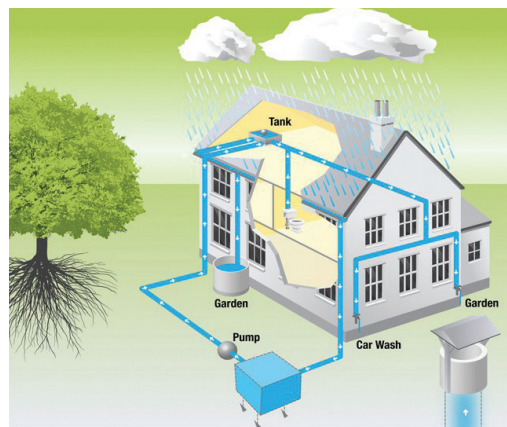

Figure 22.3 Rain water Harvesting

People living in rural areas adopt a variety of water collecting methods to capture and store as rain water. Some of the methods used are

- (i) **Digging of tanks or lakes (Eris):** It is one of the **traditional water harvesting system** in Tamil Nadu. Eris are constructed in such a way that if the water in one eri overflows, it automatically gets diverted to the eri of the next village, as these eris are interconnected.
- (ii) **Ooranis:** These are **small ponds** to collect rainwater. The water is used for various domestic purposes (drinking, washing and bathing). These ponds cater the nearby villages.

#### More to Know

kallanai Dam, also known as Grand Anicut, is the fourth oldest dam in the world, constructed by King Karikala Chola of the Chola Dynasty in the 2<sup>nd</sup> century A.D.(CE). It still serves the people of Tamilnadu, The dam is located on the River Kaveri, approximately 20 km from the city of Tiruchirapalli.

**Advantages of rainwater harvesting**

Rainwater harvesting helps to

- (i) Overcome the rapid depletion of ground water levels.
- (ii) To Meet the increase demand of water.
- (iii) Reduces flood and soil erosion
- (iv) Water stored in ground is not contaminated by human and animal wastes and hence can be used for drinking purpose.

**22.8 Electrical Energy Management**

Electricity or electric power is produced by generators. The generators are operated by the turbines attached to it. The turbines are rotated by steam, moving water or wind power to produce electricity.

**Conservation of electrical energy**

The following measures can be taken even at home and school to save electricity

- (i) Use energy efficient appliances to save electricity like Compact Fluorescent Lamps (CFL), Light Emitting Diode (LED) bulbs and other electric equipments.
- (ii) Switch off the lights and fans, television and other electrical appliances when not in use.
- (iii) Switch of the mobile phone chargers when not in use.
- (iv) Maximise the use of solar radiation. Solar water heating system can be used instead of electric geysers.
- (v) Minimise the use of air conditioners.

**22.9 E-Wastes and its Management**

E-wastes are generally called as **electronic wastes**, which includes the spoiled, outdated, non-repairable electrical and electronic devices. These wastes contain toxic metals like lead, cadmium, chromium and mercury,

though also contain iron, copper, silicon, aluminum and gold which can be recovered. Nevertheless, only 5 % of e-wastes produced are recycled.

**Sources of e-wastes**

**Electronic devices:** Computers, laptops, mobile phones, printers, monitors, televisions, DVD players, calculators, toys, sport equipments, etc.

**Household electrical appliances:** Refrigerators, washing machine, microwave oven, mixer, grinder, water heater, etc.

**Accessories:** Printing cartridges, batteries and chargers.



**E-wastes include**

Computer components	- 66%
Telecommunication components	- 12 %
Electronic components	- 5 %
Biomedical components	- 7 %
Other components	- 6 %

**Environmental impact of e-wastes**

Disposal of any kind of electrical and electronic devices without knowledge can become the landfill and water pollutants.

**More to Know**

**Health Effects of E- Wastes**

**Lead:** Damages central and peripheral nervous system; affect brain development in children

**Chromium:** Asthmatic bronchitis

**Cadmium:** Accumulates in kidney and liver; neural damage

**Mercury:** Chronic damage to brain and respiratory system

**Plastics including Polyvinyl Chloride (PVC):** Burning produces dioxin which can cause developmental and reproductive problems, damages the immuns system.

Electronic equipments contain many hazardous heavy metals such as lead, cadmium that can cause severe soil and groundwater pollution.

E-waste dumping yards and the places nearby are polluted and cause severe health hazard.

### 22.10 Sewage Management

Untreated sewage or wastewater generated from domestic and industrial process is the leading polluter of water sources in India. Sewage water results in agricultural contamination and environmental degradation.

#### Sources of Sewage/wastewater

- Domestic purpose or household activities
- Dye and textile industries
- Leather industries
- Sugar and breweries industries
- Paper and pulp industries



Figure 22.4 A view of sewage treatment plant

#### Sewage/wastewater treatment method

The conventional wastewater treatment methods involve the following steps (a) Pre-screening (b) Aeration (c) Sludge Management and (d) Water Reuse.

**Pre-screening:** Wastewater generated from domestic and industrial activities is screened to remove soil and solid particulates.

**Aeration:** Screened wastewater is then pumped to an aeration tank. Here the microbial contaminants are removed by the biological degradation that occurs in the presence of air.

**Sedimentation process:** In this process, the solid particles in suspension form are allowed to settle. The particles that settle out from the suspension is known as sludge.

**Sludge removal:** The sludge generated by the degradation process is transferred periodically from the tank for safe disposal.

**Disinfection:** Chlorination and ultraviolet (UV) radiation of treated water is required to remove any microorganism contamination.

**Water recycling:** The water will then be supplied for domestic or industrial purposes.

### 22.11 Solid Waste Management

Solid wastes mainly include municipal wastes, hospital wastes, industrial wastes and e-wastes etc. The solid wastes are dumped in the soil which results in landscape pollution.

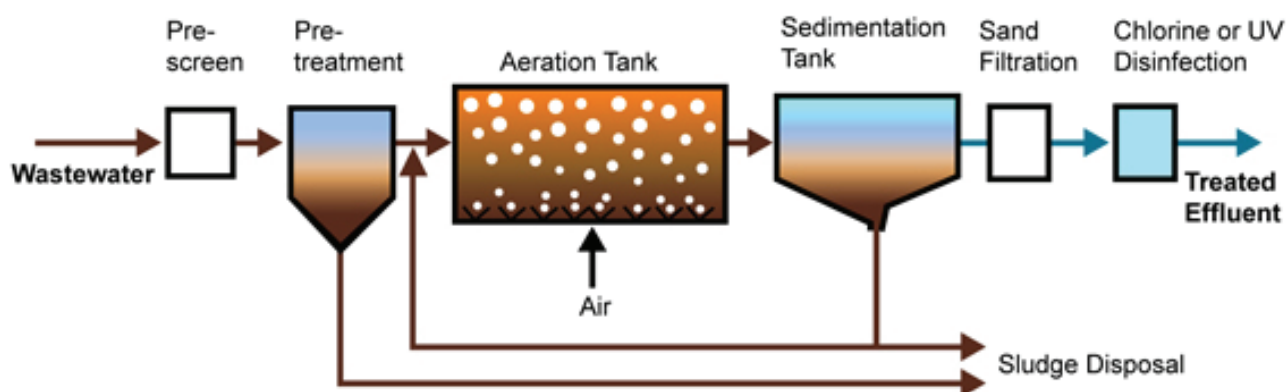

Figure 22.5 Conventional Wastewater Treatment

Solid-waste management involves the collection, treatment and proper disposing of solid material that is discarded from the household and industrial activities.

**Methods of solid wastes disposal**

- (i) **Segregation:** It is the separation of different type of waste materials like biodegradable and non biodegradable wastes.
- (ii) **Sanitary landfill:** Solid wastes are dumped into low lying areas. The layers are compacted by trucks to allow settlement. The waste materials get stabilised in about 2-12 months. The organic matter undergoes decomposition.



**Figure 22.6** Collection of degradable and non-degradable solid wastes

- (iii) **Incineration:** It is the burning of non-biodegradable solid wastes (medical wastes) in properly constructed furnace at high temperature.
- (iv) **Composting:** Biodegradable matter of solid wastes is digested by microbial action or earthworms and converted into humus.



**Figure 22.7** Collection of various types of solid wastes in separate bins

**Recycling of wastes**

- Papers from old books, magazines and newspapers are recycled to produce papers in papermills.

- Agricultural wastes like coconut shells, jute cotton stalk, bagasse of sugarcane can be used to make paper and hard board. Paddy husk can be used as livestock fodder.
- Cowdung and other organic wastes can be used in gobar gas plant to provide biogas and manure for fields.

**4R Approach**

The 4R approach such as Reduce, Reuse, Recovery and Recycle may be followed for effective waste management.

**Points to Remember**

- ❖ Conservation is a process which is concerned with the use, preservation and proper management of natural resources from destructive activities of human being.
- ❖ Conservation of natural resources contributes to the social and economic development of the country.
- ❖ Forests of a country constitute a major asset for the people of the country.
- ❖ National park is a reserved area for the conservation of entire wildlife including plants and animals.
- ❖ Sanctuary is a place reserved exclusively for the use of animals.
- ❖ Solar cell is a device that absorbs sunlight and converts it into electric energy.
- ❖ Solar water heater does not require electricity, they heat up water directly from sunlight.
- ❖ Biogas is produced by the anaerobic decomposition of cow dung.
- ❖ The technique of collecting and storing rain water for future purpose is known as rainwater harvesting.
- ❖ Unwanted, non-working and outdated electronic products become e-waste.



**TEXTBOOK EVALUATION**



**I. Fill in the blanks**

- Deforestation leads to \_\_\_\_\_ in rainfall.
- Removal of soil particles from the land is called \_\_\_\_\_.
- Chipko movement is initiated against \_\_\_\_\_.
- \_\_\_\_\_ is a biosphere reserve in Tamilnadu.
- Tidal energy is \_\_\_\_\_ type of energy.
- Coal, petroleum and natural gas are called \_\_\_\_\_ fuels.
- \_\_\_\_\_ is the most commonly used fuel for the production of electricity.

**II. State whether True or False. Correct the statements which are false**

- Biogas is a fossil fuel.
- Planting trees increases the groundwater level.
- Habitat destruction cause loss of wild life.
- Nuclear energy is a renewable energy.
- Overgrazing prevents soil erosion.
- Poaching of wild animals is a legal act.
- National park is a protected park.
- Wild life protection act was established in 1972.

**III. Match the following**

- |                    |                         |
|--------------------|-------------------------|
| 1. Soil erosion    | - energy saving         |
| 2. Bio gas         | - acid rain             |
| 3. Natural gas     | - removal of vegetation |
| 4. Green house gas | - renewable energy      |
| 5. CFL bulbs       | - CO <sub>2</sub>       |
| 6. Wind            | - non-renewable energy  |
| 7. Solid waste     | - lead and heavy metals |

**IV. Choose the correct answer**

- Which of the following is / are a fossil fuel?  
i. Tar      ii. Coal      iii. Petroleum  
a) i only      b) i and ii  
c) ii and iii      d) i, ii and iii
- What are the steps will you adopt for better waste management?  
a) reduce the amount of waste formed  
b) reuse the waste  
c) recycle the waste  
d) all of the above
- The gas released from vehicles exhaust are  
i. carbon monoxide  
ii. Sulphur dioxide  
iii. Oxides of nitrogen  
a) i and ii      b) i and iii  
c) ii and iii      d) i, ii and iii
- Soil erosion can be prevented by  
a) deforestation      b) afforestation  
c) over growing      d) removal of vegetation
- A renewable source of energy is  
a) petroleum      b) coal  
c) nuclear fuel      d) trees
- Soil erosion is more where there is  
a) no rain fall      b) low rainfall  
c) rain fall is high      d) none of these
- An inexhaustible resources is  
a) wind power      b) soil fertility  
c) wild life      d) all of the above
- Common energy source in village is  
a) electricity      b) coal  
c) biogas      d) wood and animal dung
- Green house effect refers to  
a) cooling of earth  
b) trapping of UV rays

- c) cultivation of plants
  - d) warming of earth
10. A cheap, conventional, commercial and inexhaustible source of energy is
- a) hydropower    b) solar energy
  - c) wind energy.    d) thermal energy
11. Global warming will cause
- a) raise in level of oceans
  - b) melting of glaciers
  - c) sinking of islands
  - d) all of these
12. Which of the following statement is wrong with respect to wind energy
- a) wind energy is a renewable energy
  - b) the blades of wind mill are operated with the help of electric motor
  - c) production of wind energy is pollution free
  - d) usage of wind energy can reduce the consumption of fossil fuels

**V. Answer in a sentence**

1. What will happen if trees are cut down?
2. What would happen if the habitat of wild animals is disturbed?
3. What are the agents of soil erosion?
4. Why fossil fuels are to be conserved?
5. Solar energy is a renewable energy. How?
6. How are e-wastes generated?

**VI. Short answer questions**

1. What is the importance of rainwater harvesting?
2. What are the advantages of using biogas?
3. What are the environmental effect caused by sewage?
4. What are the consequences of deforestation?

**VII. Long answer questions**

1. How does rainwater harvesting structures recharge ground water?
2. How will you prevent soil erosion?

3. What are the sources of solid wastes? How are solid wastes managed?
4. Enumerate the importance of forest.
5. What are the consequences of soil erosion?
6. Why is the management of forest and wildlife resource considered as a challenging task?

**VIII. Assertion and Reasoning**

In each of the following question a statement of assertion(A) is given and a corresponding statement of reason (R). Of the four statements given below mark the correct answer.

- a. Both assertion and reason are true and reason is correct explanation of assertion.
- b. Both assertion and reason are true but reason is not the correct explanation of assertion.
- c. Assertion is true but reason is false.
- d. Both assertion and reason are false.

1. **Assertion:** Rainwater harvesting is to collect and store rain water.

**Reason:** Rainwater can be directed to recharge the underground water source.

2. **Assertion:** Energy efficient bulbs like CFL must be used to save electric energy.

**Reason:** CFL bulbs are costlier than ordinary bulbs, hence using ordinary bulbs can save our money.

**IX. Higher Order Thinking Skills (HOTS)**

1. Although coal and petroleum are produced by degradation of biomass, yet we need to conserve them. Why?
2. What are the objectives for replacing non-conventional energy resources from conventional energy resources?
3. Why is the Government imposing ban on the use of polythene bags and plastics? Suggest alternatives. How is this ban likely to improve the environment?

**X. Value based questions**

- Why is it not possible to use solar cells to meet our energy needs? State three reasons to support your answer.
- How would you dispose the following wastes?
  - Domestic wastes like vegetable peels
  - Industrial wastes like metallic cans
 Can the disposal protect the environment? How?
- List any three activities based on 4R approach to conserve natural resources.



**REFERENCE BOOKS**

- Ghatwal G.T. and Harish Sharma, 2005. A Text Book of Environmental Studies, Himalaya Publishing House.
- P.D.Sharma, 2013. Ecology and Environment, Rastogi Publications, Meerut.



**INTERNET RESOURCES**

- <http://envfor.nic.in>
- <https://www.ovoenergy.com/guides/energy-guides/120-ways-to-save-energy.html>

**Concept Map**

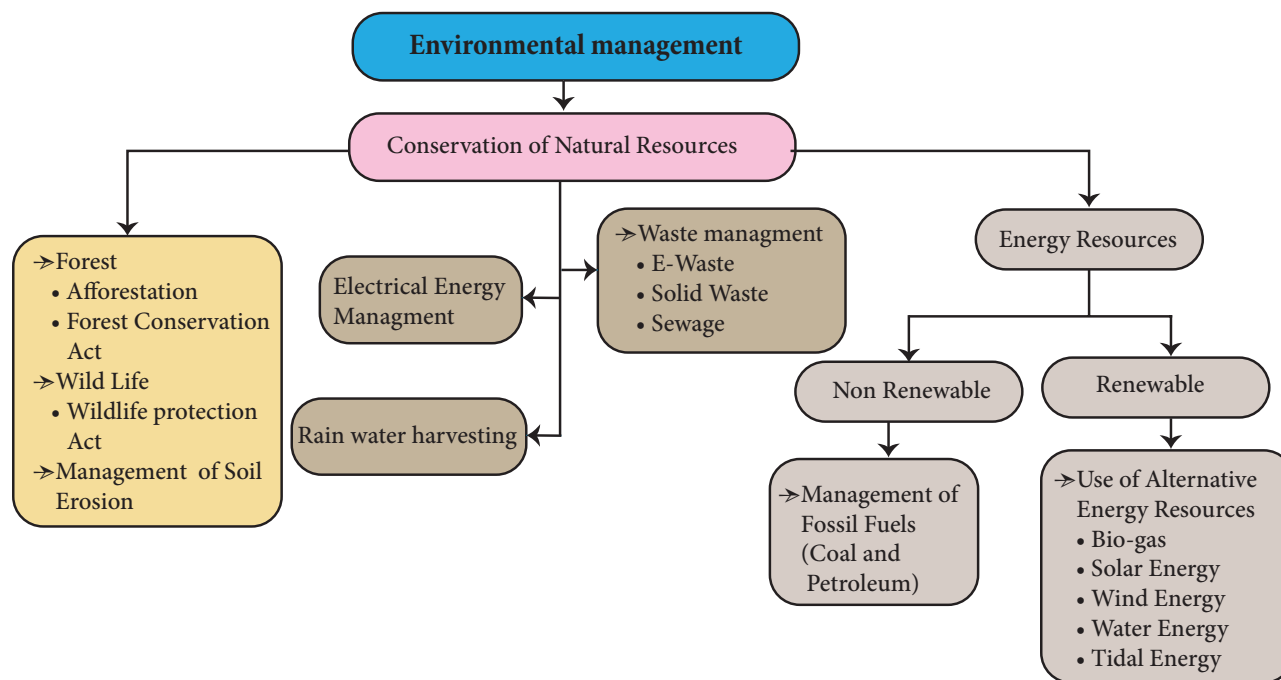





## Learning Objectives

At the end of this lesson the students will be able to:

- ◆ Differentiate a File from a Folder
- ◆ Know how to create a File and a Folder
- ◆ Use the software application to create Animation



## INTRODUCTION

In general, whenever we think of computers, the things that come to our mind is computer screen, keyboard, mouse and CPU. We learnt about computer and parts of a computer as introductory part in standard VI. Apart from that, software and hardware also plays vital role in the working of computer. Now, shall we learn how to operate the computer?



The reason we prefer computer is its speed and the ability to store data. How can we save data and information in computer? We can save

them in folders which accommodate multiple files or a single file. Let us understand the terminologies like file and folder before moving further.



### 23.1 FILE

The output we get from any application is commonly referred as 'file'. Therefore the application for the specific purposes determines the nature of the file.

**23.1.1 FOLDER**



A folder is a storage space that contains multiple files. We can create files as per the user's need. For clear understanding, we can take the example of a bookshelf in a library. The individual book can be considered as a 'file' and the whole set of books in a shelf can be considered as folders. When we right click on the mouse, the popup menu appears on the screen with multiple options. Select 'NEW' option and a secondary menu comes up with another set of options. Select 'Folder' option in the menu. You can now save your file(s) in the newly created folder.

More people are using Windows and LINUX operating systems in their computers. We can do many activities like collect notes, draw/paint, create animations /spreadsheets/ word docs/PPTs etc.

We use 'Guide Board' to go to the unknown places like that when we 'On' the computer click the 'START' button at the left corner of the computer, it shows the list of all programs in the computer. Now select the required program and create the required files.

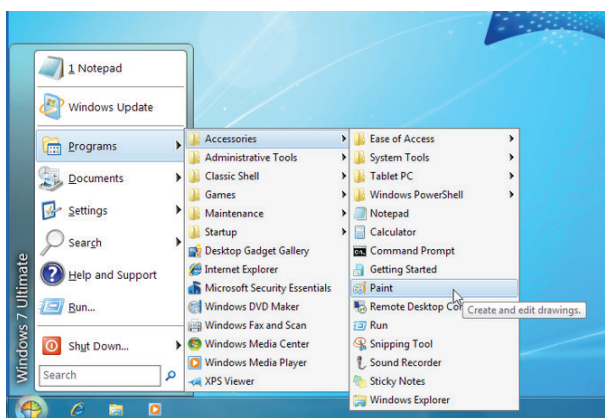

**How can we create Files?**

For example if the computer is operating on the Windows OS, we can collect our notes in 'Notepad' application and draw pictures in 'Paint' application.

As per its name we can type notes in 'Notepad' and save the created files in a folder. Likewise in the 'Paint' app we can draw and edit pictures. With these pictures, let us see how we can create image gallery, animations and graphics easily.



Pictures and audio-visuals gives us more understanding than teaching and writing on the black board. Is it right?



Instead of saying a story like 'once upon a time there was a king' we can understand the concept easily by seeing the video and also it registers firmly in the minds of the students. The device which helps in explaining the concepts easily through pictures is known as 'Visual Communication Device'. For example photos, audio -visuals, drawings, animations all these can be created easily with the help of computer. Cinema is a good example for 'Visual Communication Device'.

**23.2 SCRATCH**

**Introduction**

'Scratch' is a software used to create animations, cartoons and games easily. Scratch is a visual programming language. It

was developed in the Massachusetts Institute of Technology (MIT) Media Lab to make programming easier and more fun to learn.

### Scratch Environment Editor

The Scratch editor has three main parts: They are Stage, Sprite and Script editor.

**Stage:** Stage is the background appearing when we open the scratch window. The background will most often be white. You can change the background colour as you like.

**Sprite:** The characters on the background of a Scratch window are known as Sprite. Usually acat appears as a sprite when the Scratch window is opened. The software provides facilities to make alternations in sprite.

**Script editor / costume editor:** Where you edit your programs or your sprite's pictures.

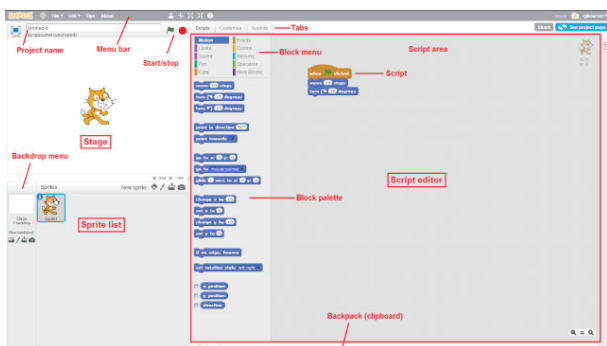

You should see a single window with at least the following three panes: the Stage (top left), the Sprite List (bottom left), and the Scripts tab (right), which contains the Blocks tab and the Scripts Area. The right pane also contains two additional tabs, Costumes and Sounds.

The script editor has three main parts:

- **Script area:** Where you build scripts.
- **Block menu:** Where you choose the category of blocks (programming statements) to use.
- **Block palette:** Where you choose the block to use.

When the Costumes tab is chosen, the costume

editor is shown (outlined in red):

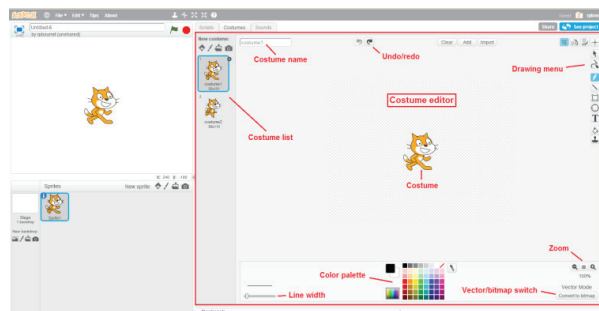

### Movement and Loops

Click File/New to create a new project and enter a project name .

Click the menu **Script** → **Event**, drag a **when green flag clicked** block to the scripts area. Your scripts area should look like this:



Click the menu **Script** → **Motion** menu, drag a **goto x: 0 y: 0** block to the scripts area and snap it to the bottom of the **when green flag clicked** block. Your script should look like this:



Add a **move 10 steps** block to the bottom of your script and change the 10 into 100.



Click the green flag at the top right corner of the stage to run your program.

**Adding Sound**

1. Click Sprite1 in the sprite list and click the Sounds tab.
2. Try the meow sound already there. If you don't like it, click the speaker icon to choose a different sound from the sound library.
3. Click the Scripts tab and find the play sound block from the Sound menu. Add this block to the when space key pressed script. (Select the sound you want from the drop-down list.)
4. Run your program.

**Example:**

Program for print the word "Hello" with sound

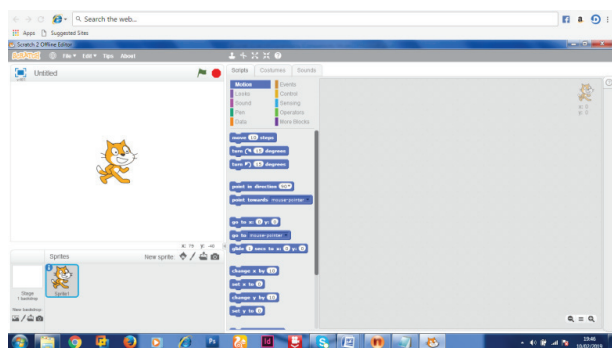

1. Click events in script option

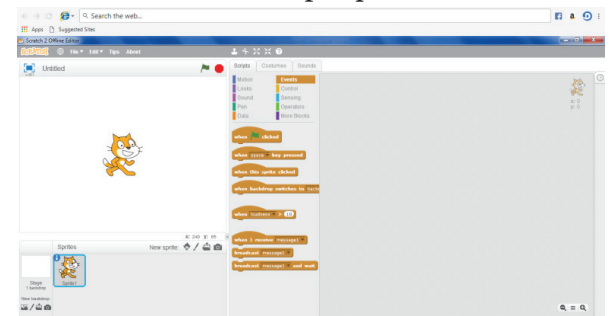

2. Drag **when clicked** tab to script area

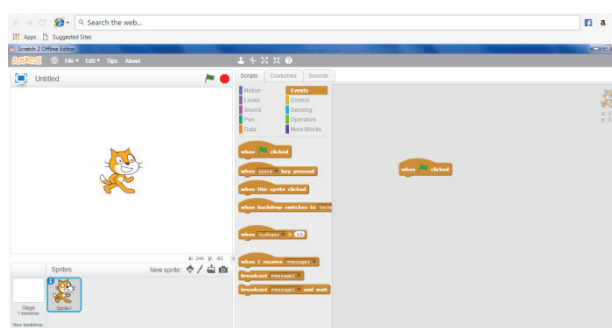

3. Click Looks in script option. Drag "say" to script area.

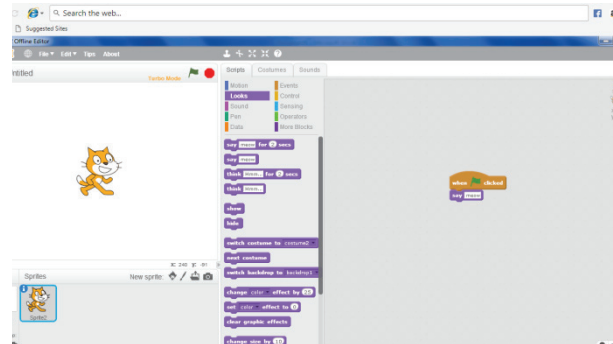

4. Type "Hello" word in say tab.

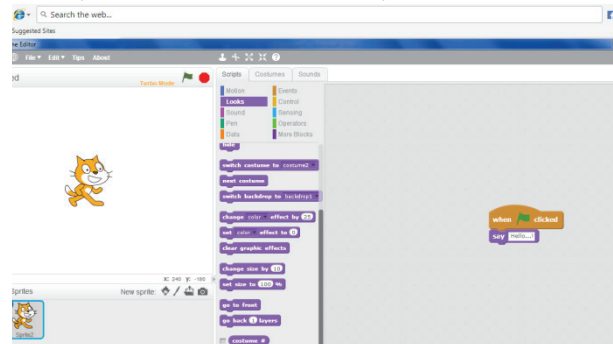

5. Click sounds in script option. Drag play sound to script area. Choose the hello sound from the audio file.

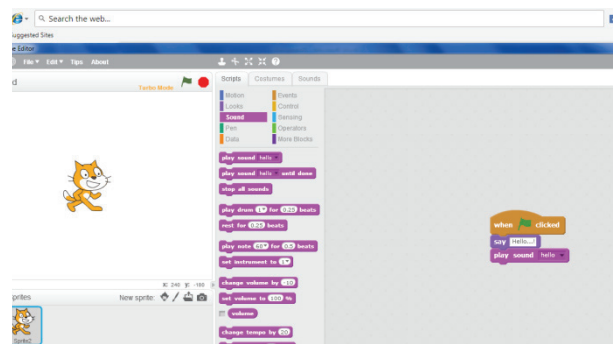

6. From File menu choose the Save option.
7. Click the green flag at the top right corner of the stage window to run the program

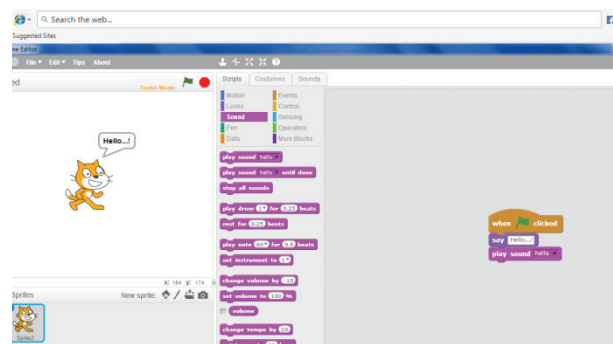

Output:

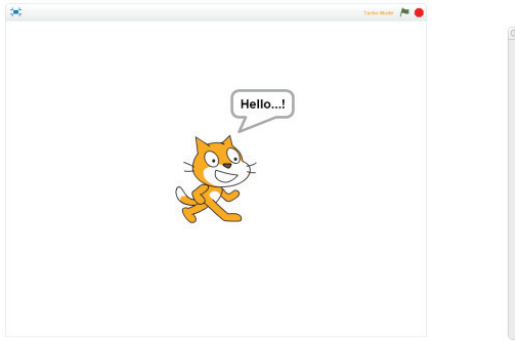

**TEXTBOOK EVALUATION**



**I. Choose the best answer**

1. Which software is used to create animation ?  
 a) Paint            b) PDF  
 c) MS Word        d) Scratch
2. All files are stored in the \_\_\_\_\_  
 a) Folder            b) box  
 c) Pai                d) scanner
3. Which is used to build scripts?  
 a) Script area      b) Block palette  
 c) stage             d) sprite
4. Which is used to edit programs?  
 a) Inkscape        b) script editor  
 c) stage             d) sprite
5. Where you will create category of blocks?  
 a) Block palette    b) Block menu  
 c) Script area      d) sprite

**II. Match the Following**

1. Script Area	Type notes
2. Folder	Animation software
3. Scratch	Edit programs
4. Costume editor	Store files
5. Notepad	Build Scripts

**III. Answer the following**

1. What is Scratch?
2. Write a short note on editor and its main parts?
3. What is Stage?
4. What is Sprite?

## PRACTICALS

S.No.		NAME OF THE EXPERIMENT	MONTH
1	PHYSICS	Determination of weight of an object using the principle of moments	June
2		Determination of focal length of a convex lens	July
3		Determination of resistivity	September
4	CHEMISTRY	Identification of the dissolution of the given salt whether it is exothermic or endothermic	June
5		Testing the solubility of the salt	July
6		Testing the water of hydration of salt	August
7		Test the given sample for the presence of acid or base	October
8	BIO-BOTANY	Photosynthesis-Test tube and Funnel Experiment (Demonstration)	June
9		Parts of a Flower	August
10		Mendel's Monohybrid cross	August
11		Observation of Transverse Section of Dicot stem and Dicot Root	October
12	BIO-ZOOLOGY	Observation of Models-Human Heart and Human Brain	July
13		Identification of Blood Cells	August
14		Identification of Endocrine Glands	October

40 minutes for each practical

PHYSICS

1. DETERMINATION OF WEIGHT OF AN OBJECT USING THE PRINCIPLE OF MOMENTS

**Aim:**

To determine the weight of an object using the principle of moments

**Apparatus required:**

A metre scale, a knife edge, slotted weights, thread



**Procedure:**

- i. A metre scale is supported at its centre of gravity by a knife edge or suspended by using a thread tied to its centre so that the scale is in the horizontal position. Ensure that the scale is in equilibrium position.
- ii. A known weight  $W_2$  and an unknown weight  $W_1$  are suspended from to either side of the the scale using the weight hangers.
- iii. Fix the position of one weight hanger and adjust the position of the second weight hanger such that the scale is in equilibrium.
- iv. Measure the distance  $d_1$  and  $d_2$  of the two weight hangers from the centre of the scale accurately.
- v. The experiment is repeated for different positions of the unknown weight. Measure the distances. The reading are tabulated as follows:

**Observation:**

S.No	Weight in the wieght hanger ( $W_2$ ) kg	Distance of known wieght $d_1$ (m)	Distance of unknown wieght $d_2$ (m)	$W_2 \times d_2$ (kg m)	Unknown weight $W_1 = \frac{W_2 \times d_2}{d_1}$ (kg)
1					
2					
3					

Mean:

**Calculations:**

Moment of a force can be calculated using the formula

Moment of the force = Force x distance

Anticlock wise moment by unknown weight =  $W_1 \times d_1$

Clockwise moment by known weight =  $W_2 \times d_2$

$$W_1 \times d_1 = W_2 \times d_2$$

$$\text{Unknown weight} = W_1 = \frac{W_2 \times d_2}{d_1}$$

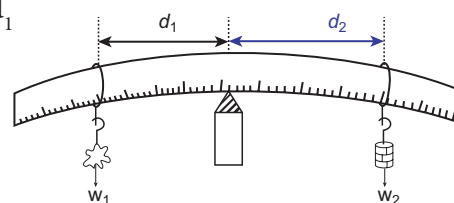

**Result:**

Using the principle of moments, the weight of the unknown body  $W_1 = \dots\dots$  Kg Wt.

## 2. DETERMINATION OF FOCAL LENGTH OF A CONVEX LENS

### Aim:

To determine the focal length of a convex lens by using

1. Distant object method
2. uv method

**Apparatus required:** A convex lens, stand, wire gauze object, screen and measuring scale.

### Formula:

$$f = \frac{uv}{(u + v)}$$

Here,

$u$  is the distance between the object (light source) and the convex lens

$v$  is the distance of the image (screen) from the convex lens

$f$  is the focal length of the convex lens

### 1. Distant Object Method:

Fix the given convex lens vertically on the stand and place it on the table near an open window of the laboratory. Locate a distant object (tree or building) through the open window. Place the screen behind the convex lens. Adjust the position of the convex lens and the screen so as to get a sharp, inverted and diminished image. Measure the distance between the screen and the convex lens with the help of the measuring scale. This distance is equal to the approximate focal length of the convex lens ( $f$ )

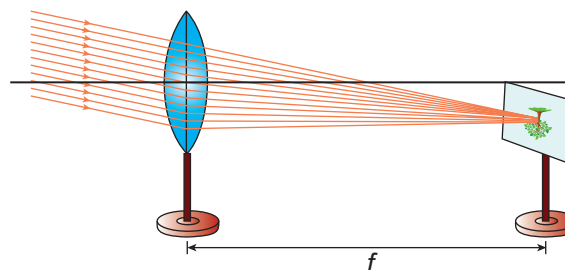

### 2. uv - Method:

Fix the given convex lens vertically on the stand and place it on the table. Place the wire gauze object on the left side of the convex lens (say at a distance greater than  $2f$ ). Measure the distance between the object and the lens ( $u$ ). Place the screen on the right side of the convex lens and adjust its position to get a sharp, inverted and diminished image. Measure the distance between the screen and the lens ( $v$ ). Repeat the same procedure, by changing the distance of the object ( $u$ ) and tabulate your observations.

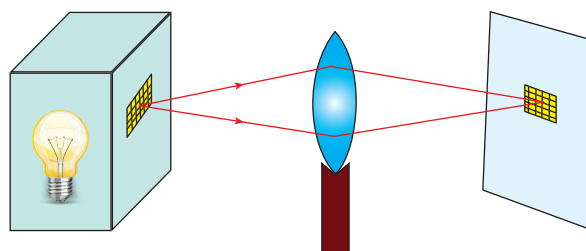



**Observation:**

Focal length of the convex lens (By distance object method) is  $(f) = \dots\dots\dots\text{cm}$

$2f = \dots\dots\dots\text{cm}$

S.No	Size of the Image	Position of the object	Distance between the object and the lens (u) cm	Distance between the screen and the Lens (v) cm	Focal length of convex lens $f = \frac{uv}{(u + v)} \text{cm}$
1	Diminished	$u > 2f$			
2					
3	Same size	$u = 2f$			
4	Magnified	$u < 2f$			
5					

**Result:**

The focal length of the given convex lens

1. By distance object method  $f = \dots\dots\dots\text{cm}$

2. By 'uv' method  $f = \dots\dots\dots\text{cm}$

**3. DETERMINATION OF RESISTIVITY**

**Objective:**

To determine the resistivity of the material of the given coil of wire.

**Equipment required:**

A coil of wire, screw gauge, a metre scale, battery, key, ammeter, voltmeter, rheostat and connecting Wires.

**Formula:**

The resistivity of the material of the coil of wire is

$$\rho = \left(\frac{A}{L}\right)R \text{ (in ohm metre)}$$

Where A is the area of cross section of the wire ( $\text{m}^2$ )

L is the length of the coil of wire (m)

R is the resistance of the coil of wire (ohm)

**Circuit Diagram:**

**Procedure:**

- Connect the battery, ammeter, given wire, rheostat and key in series, as shown in the circuit diagram.
- Connect the voltmeter in parallel to the unknown resistor.

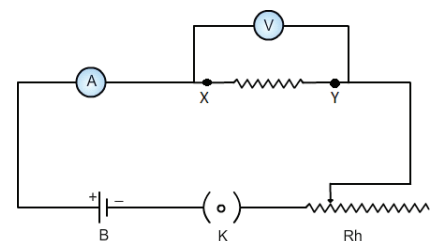

- Close the key and hence the circuit is closed.
- Adjust the rheostat such that the ammeter reads a current of 0.5 ampere.
- Note down the potential difference across the resistor as shown by the voltmeter.
- Adjust the rheostat and change the current in steps of 0.5A (that is 0.5A, 1.0A, 1.5A, etc.).
- For each current, note down the corresponding potential difference as shown by the voltmeter.
- Tabulate the observations.
- Measure the diameter of the wire using a screw gauge.
- Measure the length of the coil using metre scale

**Observations:**

**(i) To find the resistance:**

S. No	Ammeter reading-I (Ampere)	Voltmeter reading-V (Volt)	Resistance = V/I (Ohm)
1			
2			
3			
MEAN			

**(ii) To find the diameter of the wire using screw gauge:**

S. No	Pitch Scale reading-PSR (mm)	Head scale coincidence-HSC	Head scale reading- HSR=HSC×LC (mm)	Total reading = PSR + HSR (mm)
1				
2				
3				
Mean Diameter				

**Calculations:**

Radius of the wire,  $r = \text{diameter}/2 = \underline{\hspace{2cm}}$  m

Area of cross section of the wire,  $A = \pi r^2 = \underline{\hspace{2cm}}$  m<sup>2</sup>

Length of the wire  $L = \underline{\hspace{2cm}}$  m.

Resistivity of the material of the wire =  $\rho = \left(\frac{A}{L}\right)R = \underline{\hspace{2cm}}$   $\Omega$  m

**Result:**

The resistivity of the material of the wire =  $\underline{\hspace{2cm}}$   $\Omega$  m

## CHEMISTRY

## 4. IDENTIFY THE DISSOLUTION OF THE GIVEN SALT WHETHER IT IS EXOTHERMIC OR ENDOTHERMIC.

**Aim:**

To test the dissolution of given salt is exothermic or endothermic

**Principle:**

If the reaction or process liberates the heat, then it is called exothermic.

If the reaction or process absorbs the heat, then it is called endothermic

**Apparatus required:**

Two beakers, Thermometer, stirrer, weighed amount of two samples.

**Procedure:**

Take 50ml of water in two beakers and label them as A and B. Note the temperature of the water from beaker A and B. Then, add 5g of sample A into the beaker A and stir well until it dissolve completely. Record final temperature of the solution. Now, repeat the same for the sample B. Record the observation.

**Observation:**

S. No	Sample	Temperature before addition of sample (°C)	Temperature after addition of sample (°C)	Inference (temperature increases or decreases)
1	A			
2	B			

**Result:**

From the inferences made

The dissolution of sample A is \_\_\_\_\_ (Exothermic or endothermic)

The dissolution of sample B is \_\_\_\_\_ (Exothermic or endothermic)

**Note:**

Sodium hydroxide, ammonium nitrate, glucose, calcium oxide etc. may be given as the sample.

## 5. TESTING THE SOLUBILITY OF THE SALT

**Aim:**

To test the solubility of the given salt based on the saturation and un saturation of the solution at a given temperature.



**Principle:**

A solution in which no more solute can be dissolved in the solvent at a given temperature is called saturated solution. If the solvent can dissolve more solute than what is present, the solution is called unsaturated solution.

**Materials Required:**

A 250 ml beaker, a Stirrer, sufficient quantity of distilled water, 100 ml measuring jar, table salt in three packets weighing as 25g, 11g, and 1g.

**Procedure:**

In a 250ml beaker ,pour 100 ml water using measuring jar. To this water add table salt (25 g) from first packet. stir the content very well. Add the next packet containing 11 g salt followed by constant stirring . Now add the third packet containing 1 g salt . Record your observations.

**Observation:**

S. No	Amount of salt added	Observation [Salt dissolved/undissolved]	Inference [unsaturated/saturated/super saturated]
1			
2			
3			

**Result:** From the above observation, it is inferred that the amount of salt required for saturation is \_\_\_\_\_ g

## 6. TESTING THE WATER OF HYDRATION OF SALT

**Aim:**

To check whether the given sample of salt possesses 'Water of Hydration' or not. To verify the presence of water molecules in the given hydrated salt .



**Principle:**

Water of crystallization or water of hydration is the phenomenon shown by certain salts in which water molecules are present inside the crystals are responsible for their colour and geometry. e.g. Crystalline copper sulphate  $CuSO_4 \cdot 5H_2O$

**Materials Required:** A pinch of crystalline copper sulphate in a test tube, tongs, spirit lamp.

**Procedure:**

A pinch of crystalline copper sulphate taken in a test tube and heated for sometime. Water droplets are seen on the inner walls of the test tube. This shows that the given salt contains water of crystallization. If the above observation is not noticed for the given salt, the water of hydration is absent.

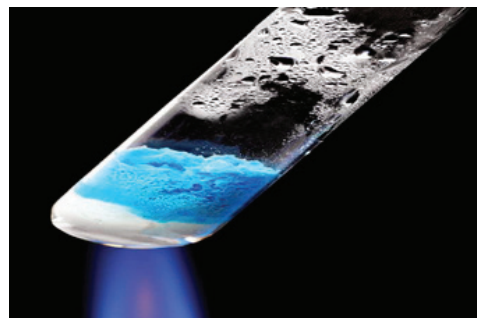

**Result:**

In the given sample of salt, Water of crystallization / hydration is

- A) Present
- B) Absent

**7. TEST THE GIVEN SAMPLE FOR THE PRESENCE OF ACID OR BASE**

**Aim:**

To identify the presence of an acid or a base in a given sample.



**Materials Required:**

Test tubes, test tube stand, glass rod, phenolphthalein, methyl orange, sodium carbonate salt and the given sample.

**Principle:**

**In acid medium,**

- (a) Phenolphthalein is colourless
- (b) Methyl orange is pink in colour
- (c) Sodium carbonate gives brisk effervescence.

**In Base medium,**

- (a) Phenolphthalein is pink in colour
- (b) Methyl orange is yellow in colour
- (c) Sodium carbonate does not give brisk effervescence.

**Procedure:**

S. No	Experiment	Observation (Colour change)	Inference (Acid / Base)
1	Take 5ml of the test solution in a test tube and add a few drops of Phenolphthalein in it.	a) No change in colour. b) Solution Turns pink in colour	a) Presence of acid b) Presence of base
2	Take 5ml of the test solution in a test tube and add a few drops of Methyl orange in it.	a) Solution Turns pink in colour b) Solution Turns yellow in colour	a) Presence of acid b) Presence of base
3	Take 5ml of the test solution in a test tube and add a pinch of sodium carbonate salt.	a) Brisk effervescence occurs. b) No brisk effervescence.	a) Presence of acid b) Presence of base

**Result:** The given test solution contains \_\_\_\_\_ (acid / base).

## BIO-BOTANY

8. PHOTOSYNTHESIS-TEST TUBE  
AND FUNNEL EXPERIMENT(DEMONSTRATION)**Aim:**

To prove that oxygen is evolved during photosynthesis.

**Materials required:**

Test tube, funnel, beaker, pond water and Hydrilla plant.

**Procedure:**

1. Take a few twigs of Hydrilla plant in a beaker containing pond water.
2. Place an inverted funnel over the plant.
3. Invert a test tube filled with water over the stem of the funnel.
4. Keep the apparatus in the sunlight for few hours.

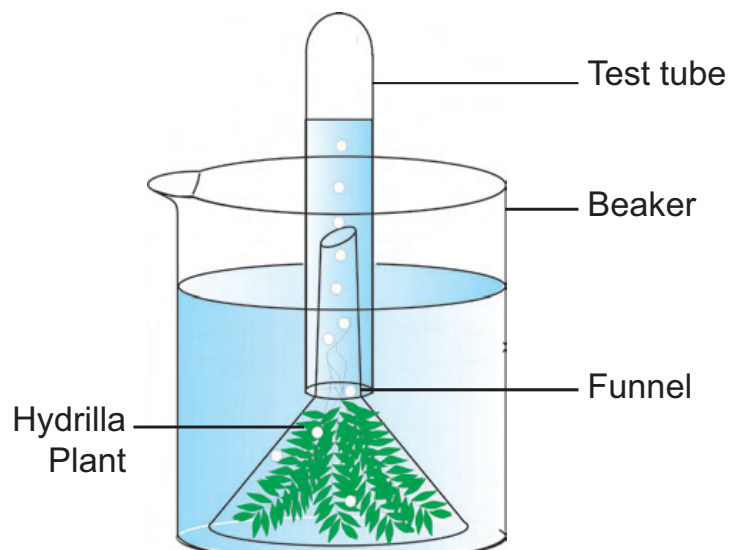
**Observation:**

After one hour, it is noted that water gets displaced down from the test tube.

**Inference**

During photosynthesis, oxygen is evolved as a by-product. Gas bubbles liberated from the Hydrilla plant reach the top of the test tube and it displaces the water downwards. Take the test tube and keep the burning stick near the mouth of the test tube. Increased flame will appear. Hence, it is proved that oxygen is evolved during photosynthesis.

## 9. PARTS OF A FLOWER

### Aim:

To dissect and display the parts of the given flower and observe the Calyx, Corolla, Androecium and Gynoecium. Draw labelled sketches.

### Materials Required:

Flower, needle and paper

### Procedure:

With the help of the needle dissect the different whorls of the flower

Floral Parts:

Calyx	}	Accessory organ
Corolla		
Androecium -	}	Reproductive organ
Gynoecium -		
		Female part of the flower

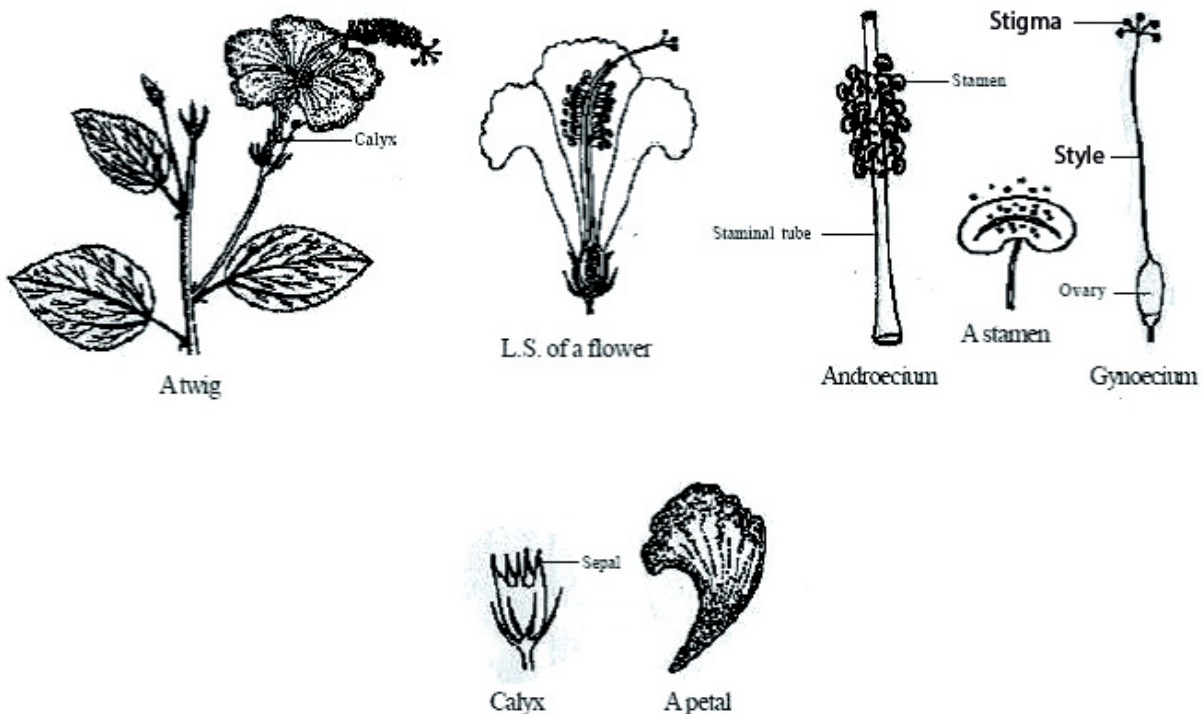

### Observation:

Draw and label the parts of the flower.





## 11. OBSERVATION OF TRANSVERSE SECTION OF DICOT STEM AND DICOT ROOT

### Aim:

To observe transverse section (T.S) of Dicot Stem / Dicot Root from permanent slides.

### Observation:

A. The given slide is identified as T.S of Dicot Stem

### Reasons

- (i) Vascular bundles are arranged in a ring.
- (ii) Conjoint, collateral, endarch and open vascular bundle.
- (iii) Ground tissue differentiated into cortex, endodermis, pericycle and pith.
- (iv) 3 to 6 layer of collenchymas tissues present in hypodermis.

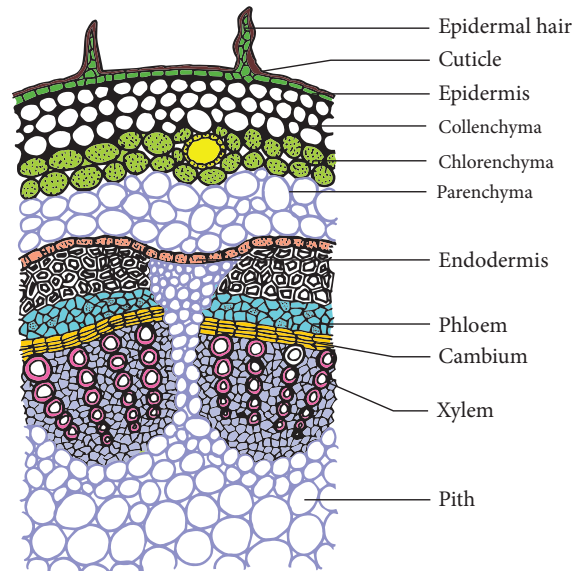

### Observation:

B. The given slide is identified as T.S of Dicot Root

### Reasons

- (i) Vascular bundle are radial
- (ii) Xylem is exarch and Tetrarch
- (iii) Casparian strips and passage cells are present in endodermis
- (iv) Cortex is made up of parenchymatous cells

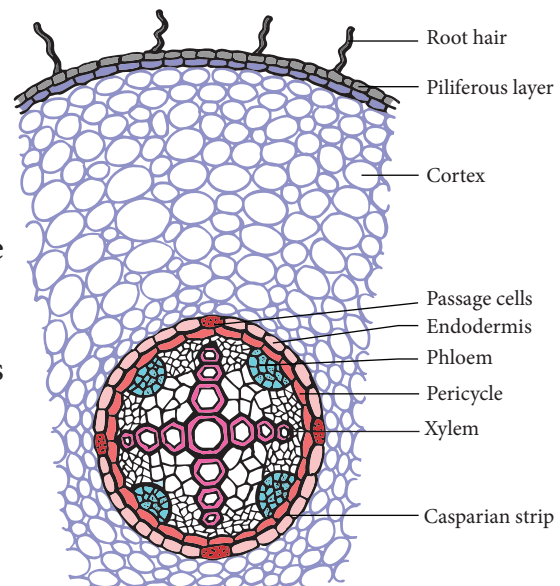

## BIO-ZOOLOGY

## 12. OBSERVATION OF MODELS-HUMAN HEART AND HUMAN BRAIN

## Identification of longitudinal section (L.S) of the human heart.

**Aim:**

To observe and draw a labelled sketch of L.S of human heart and describe the structure.

**Materials Required:**

Model showing the L.S of human heart

**Observation:**

The given model is identified as L.S. of human heart

1. The human heart has four chambers. It is made up of two auricles and two ventricles
2. The auricles are separated by interauricular septum and ventricles are separated by interventricular septum. It prevents the mixing of oxygenated and deoxygenated blood.
3. Tricuspid valve - It is located between the right auricle and the right ventricle
4. Bicuspid valve - It is located between the left auricle and the left ventricle
5. The heart is covered by a protective double walled membrane called pericardium
6. The heart pumps blood to all parts of the body.

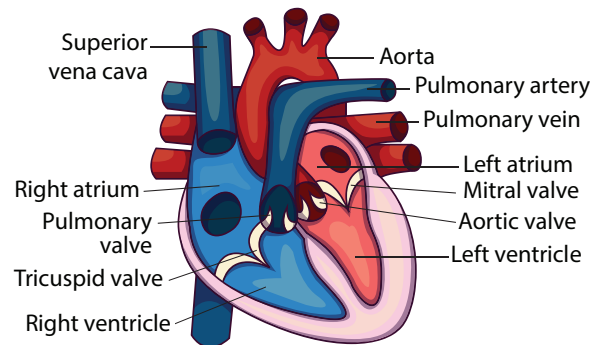

## Identification of L.S of the human brain.

**Aim:**

To observe and draw a labelled sketch of L.S of human brain and comment on it

**Materials Required**

Model showing the L.S of human brain

**Identification:**

The given model is identified as L.S. of human brain

1. The brain is enclosed in the cranial cavity
2. It is the controlling centre of all the body activities.
3. It is covered by three connective tissue membrane or meninges: Duramater Arachnoid membrane and Piamater
4. The human brain is divided into three parts namely forebrain, midbrain and hindbrain

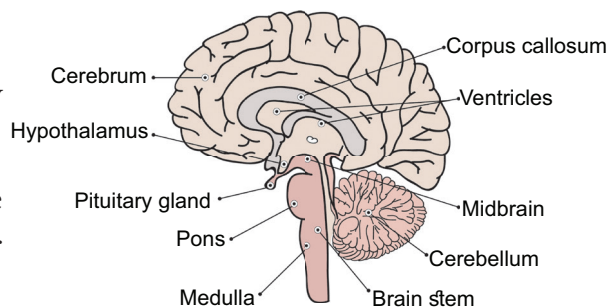

**13. IDENTIFICATION OF BLOOD CELLS**

**Aim:**

Identification of blood cells (Red blood cells and white blood cells). To draw a neat labelled diagram and write a note on the blood cells identified.

**Materials Required**

Permanent prepared slides of blood cells.

**Identification:**

The given slide is identified as **Red blood cells**

1. They are biconcave and disc shaped.
2. They are also known as erythrocytes
3. Mature mammalian RBC's do not have nucleus.
4. Haemoglobin is a respiratory pigment which gives red colour.
5. It transports oxygen from lungs to tissues and carbon- dioxide from tissues to lungs

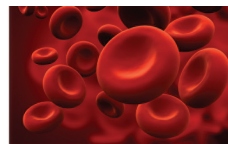

Red Blood Cells

The given slide is identified as **White blood cells**

1. WBC's are colourless and they have nucleus.
2. They are also known as Leucocytes
3. They show amoeboid movements.
4. They fight against germs and other foreign bodies and thus protect the body from microbial infections and diseases.
5. There are five different types of WBC namely Neutrophils, Eosinophils, Basophils, Lymphocytes and Monocytes

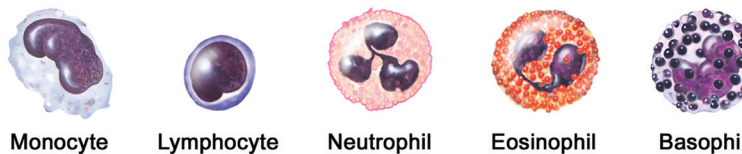

## 14. IDENTIFICATION OF ENDOCRINE GLANDS

### Aim:

To identify the endocrine gland, its location, hormone secreted and functions - Thyroid gland and Pancreas

### Materials Required:

1. Endocrine glands – (a) Thyroid gland (b) Pancreas – Islets of Langerhans
2. Any one endocrine gland should be flag labelled.

For the purpose of flag labelling a model / a chart / photograph showing all endocrine glands should be used. (Mark the endocrine glands mentioned for the practical)

### Identification:

Identify the flag labelled endocrine gland, write its location, the hormones secreted and its functions.

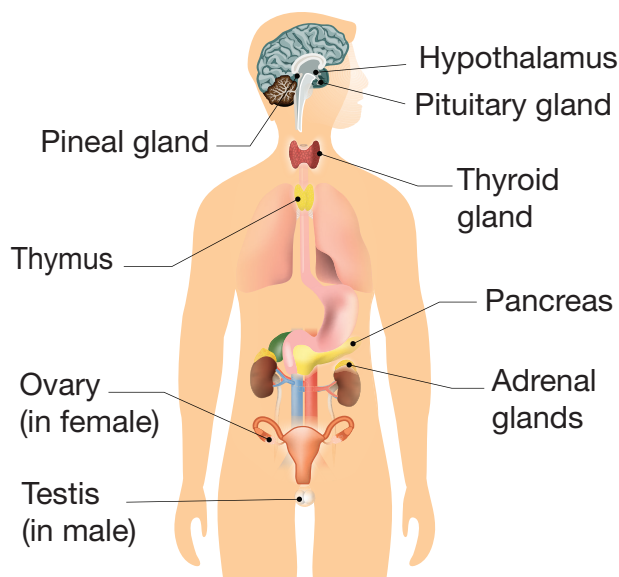

### (a) Thyroid gland

**Identification:** The flag labelled endocrine gland is identified as Thyroid gland

**Location:** Thyroid gland is a bilobed gland located in the neck region on either side of the trachea.

**Hormones secreted:** Triiodothyronine (T3) and Thyroxine (T4)

### Functions of Hormones:

1. Thyroid hormones increases the basal metabolic rate (BMR).
2. It increases the body temperature.
3. It regulates metabolism

4. It is required for normal growth and development
5. It is also known as personality hormone.
6. Deficiency of thyroxine results in simple goiter, myxoedema (in adults) and cretinism (in children).
7. Excess secretion causes Grave's diseases.

## (b) Pancreas – Islets of Langerhans

### Identification:

The flag labelled endocrine gland is identified as Islets of Langerhans in the Pancreas.

### Location:

Islets of Langerhans are seen embedded in the pancreas which is located in the abdominal region.

### Hormones secreted:

1.  $\alpha$  cells secrete glucagon
2.  $\beta$  cells secrete insulin

### Functions of Hormones:

1. Insulin converts glucose into glycogen and stores it in liver and muscles.
2. Glucagon converts glycogen into glucose.
3. Insulin and glucagon maintain the blood sugar level (80 – 120 mg/dl) by their antagonistic function.
4. Decrease in insulin secretion causes diabetes mellitus.

**GLOSSARY**

Aqueous	- நீர்க்கரைசல்
Average Atomic mass	- சராசரி அணுநிறை
Artificial transmutation	- செயற்கை மாற்றுத் தனிமமாக்கல் முறை
Anemia	- இரத்தசோகை
Addiction	- அடிமையாதல்
Apical dominance	- நுனி ஆதிக்கம்
Abscission	- உதிர்தல்
Analogous organs	- செயல் ஒத்த உறுப்புகள்
Atom Bomb	- அணுகுண்டு
Alternating current	- மாறுதிசை மின்னோட்டம்
Audible sound	- செவியுணர் ஒலி
Apparent change	- தோற்ற மாறுதல்
Carcinogens	- புற்று நோயக் காரணி
Cerebrospinal fluid	- மூளை தண்டு வட திரவம்
Crop	- தீனிப்பை
Controlled chain reaction	- கட்டுப்படுத்தப்பட்ட தொடர்வினை
Ductility	- கம்பியாக நீட்டுதல்
Deliquescent substance	- நீர் ஈர்த்து கரையும் பொருள்
Dwarfism	- குள்ளத் தன்மை
Dormancy	- தூங்கு நிலை அல்லது ஓய்வு நிலை
Dihybrid cross	- இரு பண்பு கலப்பு
Diastema	- பல் இடைவெளி
Diaphragm	- உதரவிதானம்
Dispersion	- நிறப்பிரிகை
Ethnobotany	- தாவர தொடர்பியல்
Earthing	- புவியிணைப்பு
Electric potential	- மின்னழுத்தம்
Equilibrant	- எதிர் சமனி
Functional group	- வினைச் செயல் தொகுதி
Froth floatation	- நுரை மிதப்பு முறை
Fossils	- புதை உயிர் படிமம்
Goitre	- முன்கழுத்துக் கழலை
Gigantism	- அசுரத்தன்மை
Green Revolution	- பசுமை புரட்சி
Genetic Engineering	- மரபுப் பொறியியல்
Genotype	- மரபு வகை
Geotropism	- புவிஈர்ப்பு சார்பு
Hard soap	- வன் சோப்பு
Hygroscopic substance	- நீர் ஈர்க்கும் பொருள்
Homozygous	- ஒத்த கருநிலை
Homologous organs	- அமைப்பு ஒத்த உறுப்புகள்
Hermaphrodite	- இருபால் உயிரி
Heterodont	- மாறுபட்ட பல்லமைப்பு
Hydrogen bomb	- ஹைட்ரஜன் குண்டு
Hyper meteropia	- தூரப்பார்வை
Impulsive	- உந்து விசை
Infrasonic sound	- குற்றொலி
Mass percentage	- நிறை சதவீதம்
Medulla oblongata	- முகுளம்
Mutation	- சடுதி மாற்றம்
Molds	- பூசணங்கள்

Menarche	- பருவமடைதல்
Myopia	- கிட்டப்பார்வை
Non- conventional energy resource	- மரபு சாரா ஆற்றல் வளங்கள்
Non Aqueous	- நீரிலி கரைசல் அல்லது நீரற்ற கரைசல்
Neurotransmitters	- நரம்புணர்வு கடத்திகள்
Natural radioactivity	- இயற்கை கதிரியக்கம்
Nuclear fusion	- அணுக்கரு இணைவு
Nuclear fission	- அணுக்கரு பிளவு
Nuclear reactor	- அணுக்கரு உலை
Oncology	- புற்றுநோயியல்
Pacemaker	- இதய இயக்கம் சீராக்கி
Phagocytic	- நோயணுஉண்ணி / செல்விழுங்கி
Parthenocarpic fruits	- கருவுறாக் கணிகள்
Plastids	- கணிகங்கள்
Plant breeding	- தாவர பயிர்ப் பெருக்கம்
Polyploidy	- பன்மயம்
Parturition	- குழந்தைப் பிறப்பு
Placenta	- தாய் சேய் இணைப்புத் திசு
Redox reaction	- ஆக்சிஜனேற்ற ஒடுக்க வினை
Relative molecular mass	- ஒப்பு மூலக்கூறு நிறை
Renewable energy	- புதுப்பிக்கத் தக்க வளம்
Rehabilitation centre	- மறுவாழ்வு மையம்
Response	- துலங்கல்
Reflex action	- அனிச்சைச் செயல்
Respiratory Quotient	- சுவாச ஈவு
Radioactivity	- கதிரியக்கம்
Refraction	- ஒளி விலகல்
Resolving power	- பிரிதிறன்
Resistivity	- மின்தடை எண்
Rarefactions	- நெகிழ்வுகள்
Soft soap	- மென் சோப்பு
Saturated solution	- தெவிட்டிய கரைசல்
Super saturated solution	- அதி தெவிட்டிய கரைசல்
Solubility	- கரைதிறன்
Septum	- தடுப்புச் சுவர்
Social forestry	- சமுதாயக் காடுகள்
Stomata	- இலைத்துளை
Stem cell	- மூலச் செல்
Suckers	- ஒட்டு உறிஞ்சிகள்
Segments	- கண்டங்கள்
Sanguiferous	- இரத்த உறிஞ்சிகள்
Softy measures	- பாதுகாப்பு நடவடிக்கைகள்
Stellar energy	- விண்வெளி ஆற்றல்
Spectrum	- நிறமாலை
Scattering	- ஒளிச்சிதறல்
Short circuit	- குறுக்குத் தடச்சுற்று
Un saturated solution	- தெவிட்டாத கரைசல்
Uncontrolled Chain Reaction	- கட்டுப்பாடற்ற தொடர்வினை
Umbilical cord	- தொப்புள் கொடி
Uterus	- கருப்பை
Ultrasonic sound	- மீயொலி
Vapour density	- ஆவி அடர்த்தி
Vestigial organs	- எச்ச உறுப்புகள்
Wobble	- தள்ளாட்டம்
Zygote	- கருவுற்ற முட்டை

## Science – Class X List of Authors and Reviewers

### Domain Experts

**Dr. T. V. Venkateswaran**, Scientist,  
Department of Science and Technology, Vigyanprasar, Delhi.

**Dr. Sultan Ahamed Ismail**, Scientist,  
Eco Science Research Foundation, Chennai.

**Prof. Rita John**, Professor and Head  
Dept. of Theoretical Physics, University of Madras, Chennai.

**Dr. Boopathy Rajendran**, Deputy Director  
Directorate of Elementary Education Chennai.

**Dr. V. Sivamadhavi**, Associate Professor,  
Department of Physics, Bharathi Women's College, Chennai.

**Dr. T. S. Subha**, Associate Professor and Head,  
Dept. of Botany, Bharathi Women's College, Chennai.

**Dr. R. Saravanan**, Assistant Professor,  
PG & Research Department of Zoology,  
Dr. Ambedkar Govt. Arts College, Vyasarpadi, Chennai.

**Dr. G. Ramesh**, Assistant Professor,  
PG & Research Department of Chemistry,  
Dr. Ambedkar Govt. Arts College, Vyasarpadi, Chennai.

### Authors

**Dr. R. Saravanan**, Assistant Professor,  
PG & Research Department of Zoology,  
Dr. Ambedkar Govt. Arts College, Vyasarpadi, Chennai.

**Dr. P. Priya**, Assistant Professor,  
PG & Research Department of Zoology,  
Pachiyappa's College, Chennai.

**S. Arasu**, P. G. Assistant (Chemistry),  
St. Patrick's Anglo Indian HSS, Adyar, Chennai.

**F. Davin Lalitha Mary**, P.G. Assistant (Botany),  
Christ King Girls HSS, East Tambaram, Chennai.

**K. Narayanguru**, P.G. Assistant (Physics),  
GHSS, Vadakadu, Pudukkottai.

**B. Rajarathinam**, P.G. Assistant (Physics),  
GHSS, Kodikkalpalayam, Thiruvurur.

**V. Manikandan**, P.G. Assistant (Physics),  
GHSS, Thamarapalayam, Erode.

**R. Sakthivel**, P.G. Assistant,  
GHSS, Aanaikuppam, Thiruvurur.

**S. Amutha**, P.G. Assistant,  
GHSS, Kalanivasal, Pudukkottai.

**T. Raja**, P.G. Assistant,  
GHSS, Varusanadu, Theni.

**R. Ramyadevi**, B.T. Assistant,  
GHSS, Medavakkam, Kanchipuram.

**M. Boominathan**, B.T. Assistant,  
S.K.T. Gandhi HS. Rayavaram, Pudukkottai.

**A. Sathish Kumar**, B.T. Assistant,  
GHSS, Rajendra Nagar, Theni.

**A. Chinnaraj**, B.T. Assistant,  
GHSS, Sillamarathupatti, Theni.

**V. R. Palanikumar**, B.T. Assistant,  
Raja Sethupathy GBHSS, Paramakudi, Ramanathapuram.

**V. Jayachandran**, B.T. Assistant,  
GHSS, Kallavi, Krishnagiri.

**S. Venkatraman**, B.T. Assistant,  
GHS, Sengalipuram, Thiruvurur.

**R. Sakthivel**, B.T. Assistant,  
GHS, Sellappanpettai, Thanjavur.

**S. Mohan Babu**, B.T. Assistant,  
GHSS, Veerapandi, Salem.

**S. C. Selvathangam**, B.T. Assistant,  
GHS, Mannivakkam, Kanchipuram.

**P. Nirmala Devi**, B.T. Assistant,  
GHS, Kalaiyur, Ramanathapuram.

**Dr. K. Chinthaniyalan**, B.T. Assistant,  
GHS, Periyar Nagar, Nandhambakkam, Kanchipuram.

**S. Surenderan**, Computer Teacher,  
GHS, Maathavalaayam, Kaniyakumari Dist.

### Content Readers

**Dr. V. Ranganathan**,  
District Education Officer (Retd.), Salem.

**Dr. S. Manohar**,  
ADPC, Samagraha Siksha, Salem.

**Deepak M. Chauhan**, P.G. Asst. (Retd.),  
Holy Cross Mat. HSS, Salem.

**B. Dhandapani**, P.G. Asst.,  
GHSS, Painganadu, Thiruvurur.

**S. Balasubramanian**, P.G. Asst.,  
GHSS, Murungapatti, Salem.

**V. Govindasamy**, P.G. Asst.,  
Neelambal Subramaniam HSS, Suramangalam, Salem.

### Academic Incharge

**Dr. Vanitha Daniel**, Principal  
DIET, Nagapattinam.

### Academic Coordinators

**P. Nirmala Devi**, B.T. Assistant,  
GHS, Kalaiyur, Ramanathapuram.

**Dr. K. Chinthaniyalan**, B.T. Assistant,  
GHS, Periyar Nagar, Nandhambakkam, Kanchipuram.

### Art and Design Team

#### Layout

Yogesh B  
Adison Raj. A  
Gopinath. R  
Selvakumar M  
Adaikkala Stephen. S  
Santhiyavu Stephen

#### Illustrator

Gopu Rasuvel, Muthukumar R,  
Sasi Kumar K, Prabhakar N, Vinoth Kumar

#### Wrapper Design

Kathir Arumugam

#### In-House QC

Arun Kamaraj P, C. Jerald Wilson  
Rajesh Thangappan

#### Co-ordination

Ramesh Munisamy

#### Typist

M. Sathya, Chennai

#### ICT Coordinator

**S. Indumathi**, SGT,  
PUMS, Pudukkottai Dist.

**C. Prabakaran**, SGT,  
PUMS, Thiruvurur Dist.

#### Q.R CODE.

**A. Devi Jesintha**, B.T,  
G.H.S, N.M. Kovil, Vellore.

**M. Saravanan, B.T**,  
G.G.H.S.S, Puthupalayam, Vazhapadi, Salem.

**M. Murugesan, B.T**,  
Pums. Pethavelankottagam, Muttupettai, Thiruvurur.

This book has been printed on 80 G.S.M.  
Elegant Maplitho paper.

Printed by offset at: